

Brake Adjuster Catalogue
Fren Ayar Kolu Katalođu

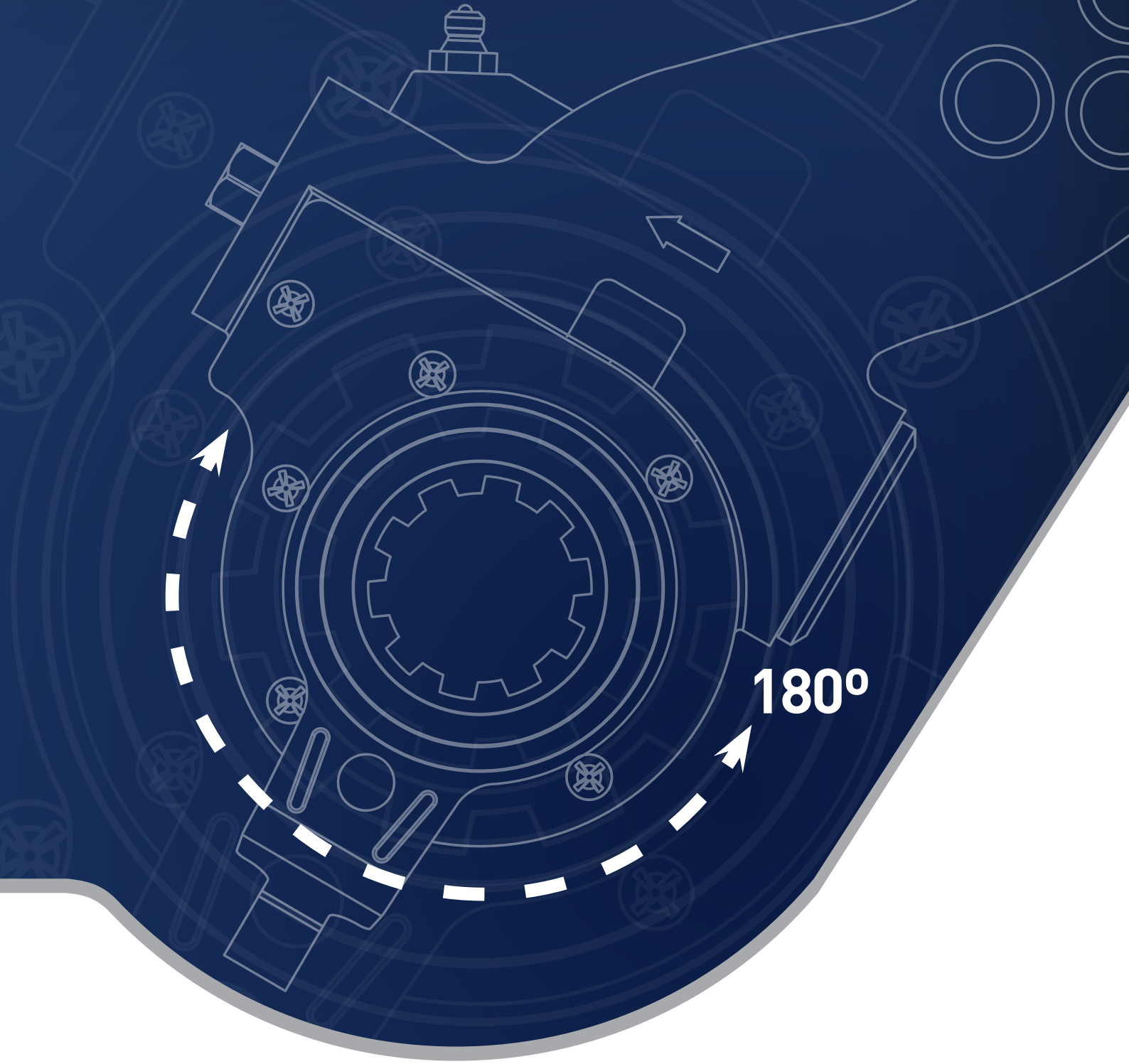

Fren Cırcırları ve Otom. Yed. Par. San. Tic. Ltd. Şti.

INDEX İÇİNDEKİLER

APPLICATION ARAÇ	PAGE SAYFA	APPLICATION ARAÇ	PAGE SAYFA	APPLICATION ARAÇ	PAGE SAYFA	APPLICATION ARAÇ	PAGE SAYFA	APPLICATION ARAÇ	PAGE SAYFA
AILSA	43	DENNIS	47	JIMECAL	55	NISSAN	62	SISU	29
AJONA	43	DONG A	48	JINAN CHINA	55	NORTH BENZ	62	SKODA	68
ALBION	43	DONGFENG	48	JP SPAIN	55	OPTARE	62	SMB	68
ALUIS	43	EATON	49	JPB	55	OTHERS	71	SOMAR PL	68
BABELSBERGER	43	ENASA	49	KÄLBLE	56	PEGASO	62	SOUTH AFRICA	68
BATTAGLINO	43	ERF	49	KAMAZ	56	PERROD	63	STAR	68
BEDFORD	44	FIAT	49	KÄSSBOHRER	40	PPS	63	STEER AXLE	68
BOMBARDIER	44	FODEN	49	KYNOS	56	RABA	63	STEFEN	68
BOVA	44	FRUEHAUF	51	LEYLAND	57	RELIANCE MERCURY	64	STEYR	68
BPW	44	GKN	52	LIAZ	59	RENAULT	34	TATRA	69
BREDAMENARINIBUS	45	GO-AXLES	52	MAG	59	REYNOLDS	64	TELCO	69
BRITSAB	45	GORICA	52	MAN	21	ROR	64	TEMSA	69
CARDI	46	HENRED-FRUEHAUF	52	MARSHALL	59	RUTHMANN	65	TOKYO CAR	69
CBM	46	HINO	52	MCW	60	SAB	65	TRAILOR	70
COBRA	46	HYUNDAI	53	MEIHOKU	61	SAE	65	VAN HOOL	42
COMAUTO	46	IKARUS	53	MENARINI	61	SAF	38	VOLVO	30
DAB	46	ISUZU	54	MILITARY TRAILER	61	SAURER	67	YORK	70
DAEWOO	46	IVECO	54	MOTORAL	61	SCAMMEL	67	YOSOKI	70
DAF	25	IVECO PEGASO	54	MÜLLER	61	SCANIA	23	ZF	70
DANA	47	JELE CZ	55	NEOCAR	61	SEDDON ATKINSON	67	ZF AXLES	71
D-C	18	JELTZ	55	NEOPLAN	62	SICCA	67		

REPAIR KITS & CONTROL UNITS / TAMİR TAKIMLARI ve KAPAKLAR

86

PART NUMBER - AYS CODE

91

AYS CODE - PART NUMBER

87

S-ABA / ABA CROSS REFERENCE LIST / S-ABA / ABA OEM KARŞILAŞTIRMA LİSTESİ 198

APPLICATION ARAÇ	PAGE SAYFA	APPLICATION ARAÇ	PAGE SAYFA	APPLICATION ARAÇ	PAGE SAYFA	APPLICATION ARAÇ	PAGE SAYFA	APPLICATION ARAÇ	PAGE SAYFA
AILSA	178	DENNIS	153	JP SPAIN	180	MULLER	169	SAMRO	181
AJONA	179	ENASA	147	JPB	181	NEOPLAN	152	SAURER	174
ALBION	179	FIAT	155	KÄLBLE	162	NISHIUMI	170	SCAMMEL	174
BABELSBERGER	146	FODEN	155	KAMAZ	162	NISSAN	181	SCANIA	111
BARTOLETTI	146	FRENELSA	180	KAROSA	163	OPTARE	170	SEDDON ATKINSON	174
BEDFORD	179	FRUEHAUF	157	KÄSSBOHRER	143	OTHERS	182	SICCA	174
B. STADT INDUSTRIE	179	GB RAILWAY	180	KYNOS	163	PANAV	170	SISU	122
BOFORS	147	GIGANT	158	LEYLAND	163	PEGASO	170	SMB	174
BOMBARDIER	147	GKN	160	LIAZ	168	PERROD	181	STAR	175
BOVA	147	GORICA	160	MAG	167	PPS	181	STEER AXLE	175
BPW	147	GRAZIANO	160	MAGIRUS	181	RABA	171	STEFEN	175
BREDAMENARINIBUS	179	HINO	161	MAN	105	RELIANCE MERCURY	181	STEYR	175
BRITSAB	150	HYUNDAI	160	MARSHALL	169	RENAULT	131	TATRA	175
CARDI	150	IKARUS	161	MCW	151	REYNOLDS	172	TEMSA	176
CBM	150	ISUZU	180	MEIHOKU	169	ROR	172	TMM	176
COBRA	179	IVECO	180	MENARINI	169	ROR/SAB	173	TRAILER	176
COMAUTO	179	IVECO CITY CLASS	180	MERCURY	169	ROR/VH	174	VAN HOOL	145
DAEWOO	179	IVECO PEGASO	180	MILITARY TRAILER	169	RUTHMANN	174	VOLVO	124
DAF	116	JELE CZ	161	MONTENEGRO	169	SAB	173	YORK	177
DANA	151	JELTZ	161	MONTRACON	169	SAE	158	ZF	177
D-C	98	JIMECAL	180	MOTORAL	169	SAF	139	ZF AXLES	178

TECHNICAL LIST OF BRAKE ADJUSTERS FOR OTHER BRANDED COMMERCIAL VEHICLES. / DİĞER ARAÇ MARKALI OTO. FREN AYAR KOLLARININ TEKNİK LİSTESİ

182

REPAIR KITS & CONTROL UNITS / TAMİR TAKIMLARI ve KAPAKLAR

185

AYS CODE - AYS S-ABA CODE - PART NUMBER

186

PART NUMBER - AYS CODE - AYS S-ABA CODE

192

S-ABA / ABA CROSS REFERENCE LIST / S-ABA / ABA OEM KARŞILAŞTIRMA LİSTESİ

198

32 U-Lock Automatic Brake Adjuster 32'Lik U Kilitli Otomatik Fren Ayar Kolu

TECHNICAL LIST / TEKNİK LİSTE

216

PART NUMBER - AYS CODE

221

CROSS REFERENCE LIST / KARŞILAŞTIRMA LİSTESİ

222

AYS Manual / Manual Brake Adjusters AYS Mekanik / Mekanik Fren Ayar Kolları

TECHNICAL LIST / TEKNİK LİSTE

232

AYS CODE - AYS MANUAL CODE - PART NUMBER

243

PART NUMBER - AYS CODE - AYS MANUAL CODE

244

CROSS REFERENCE LIST / KARŞILAŞTIRMA LİSTESİ

245

COMPANY PROFILE FİRMA PROFİLİ

AYDINSAN, is leader of invention of new items which is started manufacturing parts for commercial vehicles, since 1966. After some researches and feasibility studies, focused on manufacturing brake systems of commercial vehicles.

At presently, AYDINSAN is located at Konya Industrial zone with **25.000 sqm** area, and is producing Automatic Brake Adjuster, Self Setting Automatic Brake Adjuster (S-ABA type), Manual Brake Adjuster, 32 U-Lock Automatic Brake Adjuster and Air Disc Brake and Caliper Repair Kits for bus, truck and trailers.

R & D department is being studied to design new products, develop the quality of range of Brake Adjusters and apply new technologies to producing processes and design new fixtures and tools. These studies are carried out by qualified engineers using Auto-CAD and Pro-Engineer software.

Our test laboratory is furnished with necessary equipments and devices for applying **SAE J1462** test standards which are Functional Test, Corrosion Test, Durability Test, Waterproof Test and Statistical Test. Also, studies of FMEA, SPC applications and APQP, PPAP and MSA already are started.

1972|1973|1974|1975|1976|1977|1978|1979|1980|1981|1982|1983|1984|1985|1986|1987|1988|1989|1990|1991|1992|1993|1994|1995|1996|1997|1998|1999|2000|2001|2002|2003|2004|2005|2006|2007|2008|2009|2010|2011|2012|2013|2014|2015|2016|2017|2018|2019|2020|2021|2022|2023|2024|2025

1966

SINCE



Sektöründe yeniliklerin öncüsü olan AYDINSAN; 1966 yılında ticari araçlar için yedek parça üretimine başlamış, 1990'lı yılların sonunda yapılan ulusal ve uluslararası piyasa analizleri sonucunda üretimini, ticari araçların fren sistemleri üzerinde odaklamıştır.

Konya 3.Organize Sanayi Bölgesindeki **25.000 m²**'lik alanda faaliyet gösteren AYDINSAN; otobüs, kamyon, dorse gibi ağır ticari araçların fren sistemleri için Tam Otomatik Fren Ayar Kolu (S-ABA tipi), Otomatik Fren Ayar Kolu, Mekanik Fren Ayar Kolu, 32'lik U Kilitli Otomatik Fren Ayar Kolu ve Havalı Disk Fren Sistemleri ile Kaliper Tamir Takımlarını kendi patentleriyle üretmekte olup; Fren Ayar Kolları ve Havalı Disk Fren Sistemleri konusunda ülkemizde sektör lideridir.

Ürün kalitesinin geliştirilmesi, Ar-Ge departmanımızın yaptığı profesyonel çalışmalar sonucunda; ürünlerin dayanım ve aşınmaya karşı tasarlanan test cihazları ile kaliteleri artırılmış, yeni tasarımlarımızla birlikte ürün çeşidimiz 3.750'nin üzerine çıkarılmıştır.

Laboratuvarımızda **SAE J1462** standardına göre ürünlerimize uyguladığımız Fonksiyon Testlerinden; Aşırı Sıcaklık Şartlandırması Testi, Korozyon ve Sızdırmazlık Testi, Fren Ayar Kolu Statik (Dayanıklılık) Testleri ile kaliteli, istikrarlı, verimli ve ekonomik üretimi gerçekleştirmek için çok yönlü Ar-Ge faaliyetlerine durmaksızın devam etmekteyiz. Firma bünyesinde FMEA, SPC uygulamaları, APQP, PPAP ve MSA çalışmaları başlatılmıştır.

Üretimde kullanılan döküm parçaların istenilen özelliklerde üretilmesi amacıyla otomasyonlu döküm hattı fabrikamız bünyesine entegre edilmiştir.

1994|1995|1996|1997|1998|1999|2000|2001|2002|2003|2004|2005|2006|2007|2008|2009|2010|2011



AYDINSAN PRODUCTS ÜRÜNLER

**S-ABA (SELF SETTING)
AUTOMATIC BRAKE ADJUSTER**
TAM OTOMATİK FREN AYAR KOLU



Patent Number:
Patent No:
2008/05758

**MANUAL
BRAKE ADJUSTER**
MEKANİK FREN AYAR KOLU



Patent Number:
Patent No:
2009/09499

**AUTOMATIC
BRAKE ADJUSTER**
OTOMATİK FREN AYAR KOLU



Utility Number:
Faydalı Model No:
2008/08662

**32 U-LOCK
AUTOMATIC BRAKE ADJUSTER**
32'lik U KİLİTLİ OTOMATİK FREN AYAR KOLU



**AIR DISC
BRAKE**
HAVALI DİSK FREN

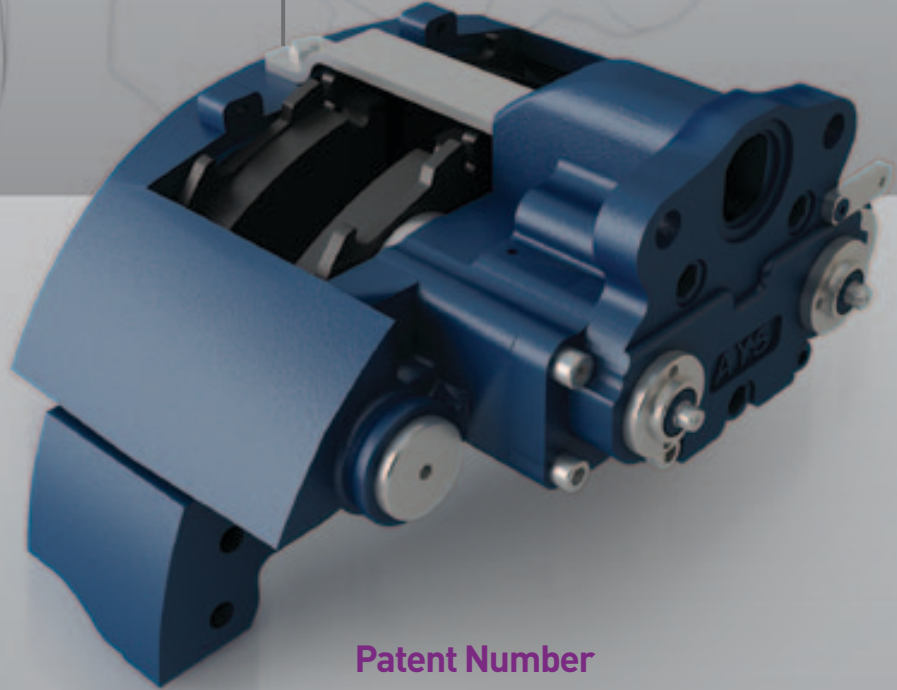

Patent Number

Patent No:
2009/03840

R&D AR&GE

R&D is set up for new product design, improving of current products and for adaptation of new Technologies. Auto-cad, pro-engineer and related Cad-Cam programs are used for product design by high qualified engineers.

Prototype new products are taken into performance and durability tests at new R&D test laboratory.

After R&D works, 3 different products designed and international patent rights are taken. Presently, these 3 new products are exported to 38 different countries.

R&D teams are studying assembly & production automation, product special control and testing devices which are used for reliability and production efficiency. Additionally robots and automation projects are our current projects to obtain faster production free of failures.

Yeni ürünlerin tasarımı, Mevcut ürünlerin geliştirilmesi ve Yeni teknolojilerin firmaya kazandırılması amacı ile Ar-Ge departmanı kurulmuştur.

Yeni ürün tasarımları, nitelikli mühendis ve teknisyenler tarafından Auto-CAD ve Pro-Engineer CAD/CAM yazılımları kullanılarak yapılmaktadır. Tasarlanan ürünlerin; seri imalat koşullarında prototip üretimi gerçekleştirilmektedir. Prototip ürünler; Ar-Ge laboratuvarı bünyesindeki ürün test cihazlarında performans ve ömür testlerine tabi tutulurlar.

Yapılan Ar-Ge çalışmaları sonucunda 3 ayrı ürün dizayn edilmiş olup; bu ürünlerin uluslararası patent hakları alınarak 38 ülkede ihracatına başlanmıştır.

AR-GE departmanı tarafından montaj otomasyonu, üretim otomasyonu, ürüne özel kontrol ve test cihazları tasarlanıp üretilerek; üretim ve montajda kapasite artırma çalışmaları yapılmıştır.

Ayrıca Robot ve Otomasyon projeleri ile hızlı ve hatasız üretim hedeflenmektedir.



FOUNDRIY DÖKÜMHANE

In order to supply quality product to our customers, recently own foundry was started operating with 1500 t/pa.

This place is equipped with all necessary tools and equipments, from melting till to sandblasting which are chemically testing and analysing, mechanical tests such as hardness, mictrostructure and tensile tests.

Müşterilerimize daha kaliteli ürün sunabilmek için; yıllık 1500 ton kapasiteli entegre dökümhane tesisimizi faaliyete geçirdik. Dökümhanemizdeki ergitme ocağı çift potalı 500 kg/saat'lik eğritme kapasitelidir.

60 derece/saat kalıp hazırlama kapasiteli Yatay Otomatik Kalıplama Hattımızda; 5m³/saat kum hazırlama ünitesi mevcuttur. Ayrıca hattımızda tamamlayıcı olarak derece bozma, sarsak, kalıplama presi, çevirici, elek, mikser, bant, konveyörler, çeviriciler, derece kapama bulunmaktadır. Döküm parçaların 1,5 ton/saat kapasiteli askılı tip kumlama makinemizde temizlemesi yapılmaktadır.

Ergimiş metalin karbon, silis ve sıcaklık kontrolleri; dökülmüş ürün üzerinde de sertlik ve mikro yapı kontrolleri yapılmaktadır.

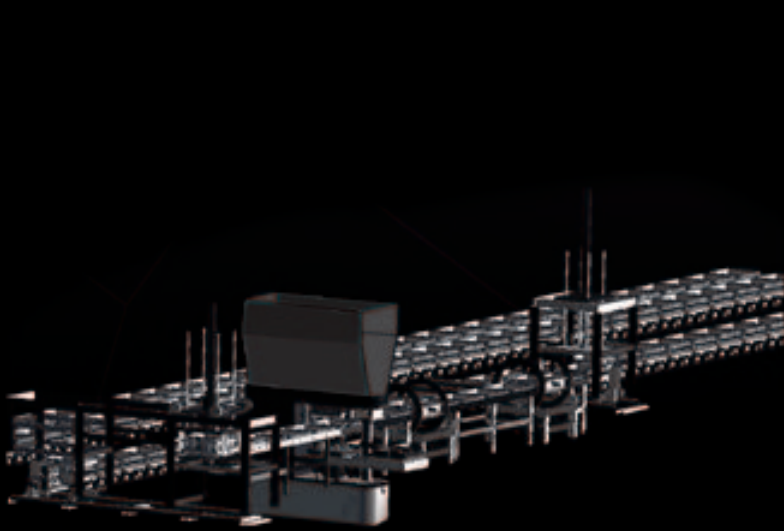

Horizontal Automatic Moulding Line / Yatay Otomatik Kalıplama Hattı



PRODUCTION STEPS ÜRETİM



AYS brake adjusters are being manufactured with five different production methods which as follows

AYS Fren ayar kolları fabrikamız bünyesinde 5 ayrı hatta seri imalat koşullarında, belirlenen proses akışına göre üretilmektedir.

Casting / Döküm Hattı:

Horizontal automatic moulding, sand preparation&transfer, surface cleaning, and melting furnace are used in production processes.

Yatay Otomatik Kalıplama, Kum Hazırlama ve Taşıma, Maça Hazırlama, Yüzey temizleme Hattı ve Ergitme Ocaklarından oluşmaktadır.

Machining / Talaşlı İmalat Hattı:

Casted bodies are machined at our horizontal&vertical machining centers with special fixtures.

Production of different gear are produced at CNC lathes with multi axles, special surface grinding lathes.

Fren Ayar Kolu gövdelerinin üretimi; firmamız tarafından tasarlanan özel fikstür ve bağlama aparatlarıyla CNC Yatay ve Dikey İşleme Merkezlerinde yapılmaktadır.

Kurma ve dişli mekanizmalarının üretimi; Çok Milli CNC Tornalar, Silindirik ve Yüzey Taşlama Tezgahları, CNC azdırma ve Fello Diş Açma, Dikey Broş Çekme ve Ovalama tezgâhlarında yapılmaktadır.



Metal Works / Sac İşleme Hattı:

Sheet metals which are purchased in different dimensions, are formed and shaped at special designed presses.

Değişik ölçü ve ebatlarda alınan sac ham malzemeler; Eksantrik Preslerde servo sac sürücülerini kullanarak, sac işleme hattında işlem görmektedir.

Painting / Boya Hattı:

After machining the bodies are cleaned chemically for electrostatic painting.

İşlenmiş olan gövdeler temizleme hattından geçirilerek, Elektrostatik boya hattında boyama işlemi gerçekleştirilmektedir.

Assembly / Montaj Hattı:

Brake adjusters are assembled and automatic and manual production lines. They are packed after lubrication, cleaning and final control.

These operations are done in 100 different machines.

Fren ayar kolları, beslemeli ve yarı otomasyonlu Otomatik ve Mekanik 2 ayrı montaj hattında montaj edilmektedir. Montajı tamamlanan ürünler son kontrolden sonra yağlama, temizleme hattından geçirilerek paketleme hattında paketlenmektedir.

Firma bünyesinde; 5 ayrı hatta bulunan tezgâhlarla birlikte 100'ün üzerinde tezgah bulunmaktadır.

QUALITY KALİTE

All AYDINSAN activities are maintained with process of approaching and customer focus. To produce high quality and economic priced products which meet customer desire, we established DIN EN ISO 9001 quality management system that is maintained and continuously improved. Our quality management system was certified by TUV NORD (Germany)

Spectrometer, CMM, Coating Thickness Measurement Equipment, Profile Projector, Metalographical Sample Inspection Equipments, Profile Measurement Equipment, Digital Micro-Hardness Tester, Spring Tension Measurement Equipment, Brake Adjuster Seal Tester, Brake Adjuster Static Tester and Spring durability and life testing Equipment are used in all necessary Laboratory tests which have been defined in product approval process at all defined steps.

Brake Adjusters are subjected to, according to SAE J 1462 such as Function Test, Excessive temperature Conditioning Test, Corrosion and Leakage Test, Dust Test, Auto Adjustment Function Tests Strength, Low Application Performance Testing and Brake Adjuster Static Pressure (Resistance) Tests in our product testing laboratories.

Additionally our products have been certified with TSEK certification by TSE, GOST-R certification by Russia Federation.

Tüm faaliyetlerini süreç yaklaşımli ve müşteri odakli olarak yürüten firmamız, müşterilerimizin ihtiyaçlarını daha iyi karşılamak amacıyla DIN EN ISO 9001 Kalite Yönetim Sistemi gerekliliklerini sağlayarak üretimindeki her noktayı kontrol altına almıştır. Kalite yönetim sistemimiz TUV NORD (Almanya) tarafından sertifikalandırılmıştır.

Ürünlerimizin gerekli kalite kriterlerine uygun olarak üretilmesi amacıyla laboratuvarlarımızda girdi kalite kontrol ve Ar-Ge çalışmaları kapsamında; Spektrometre, CMM (3 Boyutlu Ölçüm Cihazı), Kaplama Kalınlığı Ölçüm Cihazı, Profil Ölçüm Cihazı, Metalografik Numune Kesme Cihazı, Otomatik Numune Kalıplama Cihazı, Metalografik Numune Taşlama-Parlatma Cihazı, Metalografik Mikroskop, Dijital Mikro-Sertlik Ölçüm Cihazı, Profil Projektör, Yay Tansiyonu Ölçüm Cihazı, Fren Ayar Kolu Sızdırmazlık Test Cihazı, Fren Ayar Kolu Statik Test Cihazı, Yay Dayanıklılık ve Ömür Test Cihazı ile test, analiz ve ölçüm yapılmaktadır.

Fren ayar kolları; SAE J1462 standardına göre; ürün test laboratuvarımızda Fonksiyon Testi olarak, Aşırı Sıcaklık Şartlandırması Testi, Korozyon ve Sızdırmazlık Testi, Toz Testi, Otomatik Ayar Fonksiyonu Dayanım Testi, Düşük Uygulama Basıncı Performans Testi ve Fren Ayar Kolu Statik (Dayanıklılık) Testlerine tabi tutulmaktadır.

Ürünlerimiz, Türk Standartları Enstitüsü tarafından TSEK belgesi; Rusya Federasyonu tarafından GOST-R uygunluk belgesi ile sertifikalandırılmıştır.



DON'T LEAVE CHANCE, USE TECHNOLOGY

ŞANSA BIRAKMAYIN, TEKNOLOJİ KULLANIN...

We improve and apply latest technology for maximum security and we care you always as before. Highways are most secure and safe with us.

Maksimum güvenlik için ihtiyaç olan yenilikleri, her zaman olduğu gibi, sizin için geliştiriyor insan hayatına gereken önemi veriyoruz. Bizimle yollar her zaman olduğundan daha da güvenli.





**EACH OPERATOR IS QUALITY CONTROLLER!
HER OPERATÖR BİR KALİTE KONTROLÇÜDÜR!**

ASSEMBLY MONTAJ

The assembly of our Brake Adjusters which is content of 26, 22 and 11 pieces, is done by our qualified personel. By using barcode system, we and our customers follow up the product more easy.

Ürünlerimizin montajı; beslemeli, yarı otomasyonlu Otomatik ve Mekanik Montaj Hatlarında eğitimli montaj ekibi tarafından yapılmaktadır. 26, 22 ve 11 ayrı parçadan oluşan fren ayar kollarının montaj uygunluk kontrolü kalite kontrol birimi tarafından denetlenmektedir. Montajı yapılan ürünlerin izlenebilirliği barkot sistemi ile sağlanmaktadır.

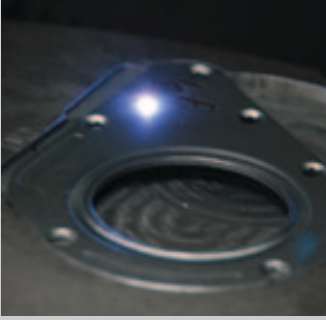

LOGISTIC LOJİSTİK

Lead time for delivery, if it is in stock within 7 days, or if it will be produced, delivery period is 3-4 weeks. Also, our sales department will assist for transport from Turkey to another country, if it is required.

Müşteri memnuniyetinin kaliteli ürün üretmek kadar önemli olduğuna inanan firmamız, stoklu ürünlerin sevkiyatlarını 7 iş günü, sipariş üzerine hazırlanan ürünlerin sevkiyatlarını 15 iş günü, üretimine yeni başlanmış veya başlanacak ürünlerin sevkiyatlarını ise 30 iş günü içerisinde yapmaktadır.



CODE SYSTEM Kodlama Sistemi

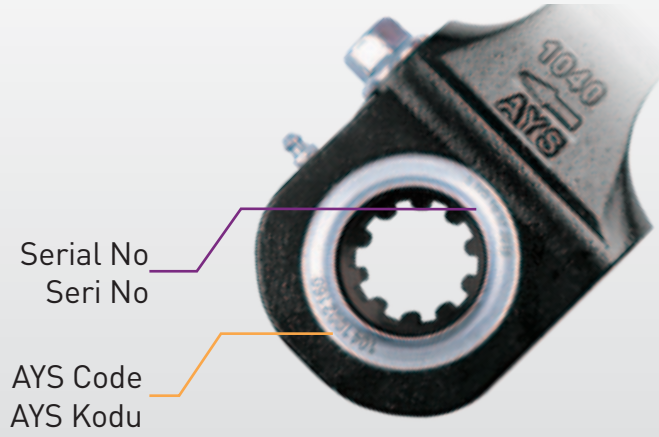

Control Unit No
Kapak No

AYS Code
AYS Kodu

Serial No
Seri No

Barcode
Barkod

AYS 800070.530
110910049503658

HOW TO USE THE CATALOGUE Katalog Kullanım Kılavuzu

SAF

2752

E

AYS CODE
321300

PART NUMBER
72053

AYS S-ABA CODE
803210

OEM NO
4W1125

	AYS CODE	CASTING	CONTROL UNIT	APPLICATION	SPLINE TEETH	NO of HOLE	H1	H2	H3	H4	H5	H6	H7	BUSHING (mm)	SPLINE TYPE	CONTROL ARM
D	321200	4076	511	SAF	10	5	250	180	150	130	110			14 (L1: x)	SAE 1 1/2" 10 C	bent
E	321300	2752	270	SAF	10	4	210	180	150	125				14	SAE 1 1/2" 10 C	double bent (short; R=65 mm)
F	321400	3068	422	SAF	10	3	198	173	148					14	SAE 1 1/2" 10 C	bent
G	250800	3163	768	D-C	26	1	130							14	N42x1.5x9H DIN 5480	double bent (short; R=65 mm)

THE USE OF THE CROSS REFERENCES LIST Ürün Karşılaştırma Listesinin Kullanımı

1

If you know OEM NO go to
S-ABA / ABA CROSS REFERENCE LIST
OEM Numarasını biliyorsanız;
S-ABA / ABA OEM Karşılaştırma Listesine bakınız.

2

If you know competitor code go to
PART NUMBER - AYS CODE - AYS S-ABA CODE
Üretici Numarasını biliyorsanız;
PART NUMBER - AYS CODE - AYS S-ABA listesine bakınız.

OEM NO	AYS S-ABA CODE	E NO	AYS CODE	PAGE NO
4W1115	802300	39	322601	140
4W1120	802305	39	322611	140
4W1125	803210	40	321300	140
4V 1130			37 640	141
4V 1135			37 630	
4V 1150	803170	64	534860	

PART NUMBER	AYS CODE	AYS S-ABA CODE	PAGE NO
72041	485110	800040	104
72046	469240	801740	103
72053	321300	803210	140
72054	290103		101
72055	570780		104



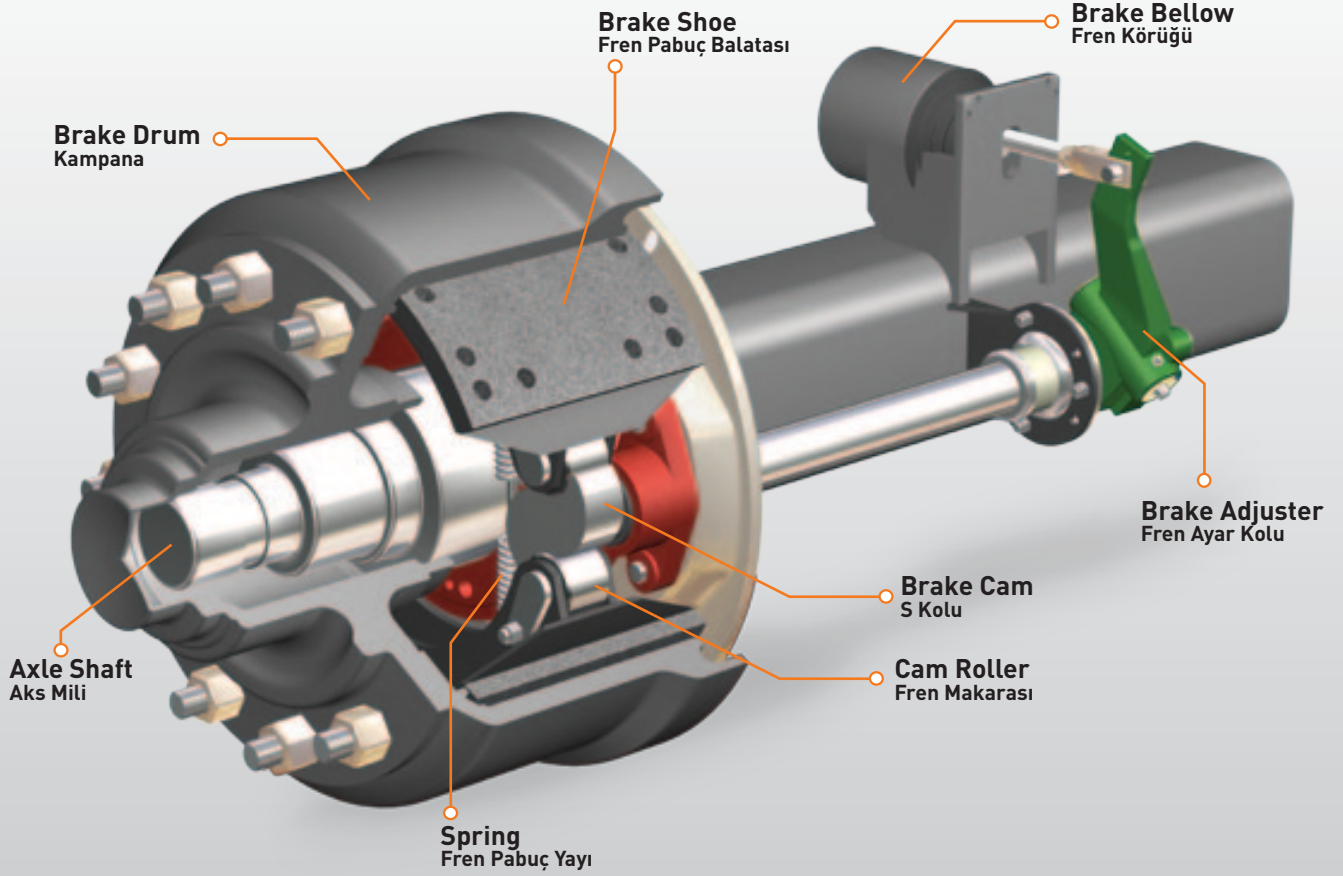

WHAT IS BRAKE ADJUSTER? FREN AYAR KOLU NEDİR?

The brake is driven with air. The air filled in the brake blower activates the blower. Being activated by the air, the blower drives the Brake Adjuster. Being co-activated, the S-arm drives the Brake Blocks. Thus, braking process has been completed when the brake linings have become worn and torn in time, the movement of Brake Adjusters do not reach enough for braking. At this point, Automatic Brake Adjuster imposes itself into the operation circuit. Automatic Brake Adjuster adjusts the clearance distance formed between the drum and linings and secures a safe braking result. The brake adjusters are adjustable for different variety of vehicles, by using suitable arm forms, and thus, they can be used wherever S-Camshafts are utilized.

Automatic Brake Adjusters do automatically secures that the clearance between the linings and drum is kept fixed and unchanging.

They keep the stroke of blower shorter, resultantly air consumption becomes less.

Automatic Brake Adjusters cause braking dynamism to function more regularly.

Braking effect is rapid and safe. Braking on all whells are achieved in safe arrangement and harmony.

Automatic Adjustment mechanism of the Brake Adjusters are covered for protection against dust end external knocks and strokes.

The braking balance of the vehicle is maintained by brake adjusters.

Fren havayla çalışır. Fren körüğünün içine dolan hava körüğü harekete geçirir. Harekete geçen körük fren ayar kolunun harekete geçmesini sağlar.

Aynı zamanda harekete geçen S kolu fren bloklarını harekete geçirir. Böylece fren yapılmış olur. Balata aşındıkça fren ayar kolunun hareketi fren yapmaya yetiştir. Burada devreye otomatik fren ayar kolu girer.

Otomatik fren ayar kolu, kampana ile balata arasında meydana gelen boşluğu ayarlar ve güvenli fren yapılmasını sağlar. Fren ayar kolları; araçlar için uygun kol şekilleriyle ayarlanabilir olup, uygun kol şekilleri ile beraber S-Kam Frenlerinin uygulandığı her yerde kullanılabilir.

Otomatik fren ayar kolu, otomatik olarak balata ile kampana arasındaki boşluğun sabit kalmasını sağlar. Fren körüğünün strokunu kısa tutar, böylece kullanılan hava sarfiyatı az olur.

Otomatik fren ayar kolu, fren dinamizmini daha düzenli kılar. Frenleme çabuk ve emniyetli olup, bütün tekerleklerde frenlemeyi düzenli kılar. Fren ayar kolunun otomatik ayar mekanizması kapalıdır, rutubet, toz ve darbelere karşı korunmuştur. Aracın fren dengesi otomatik fren ayar kollarıyla ile sağlanır.

PATENTED
PATENTLİ

Patented No./Patent No
2008/05758

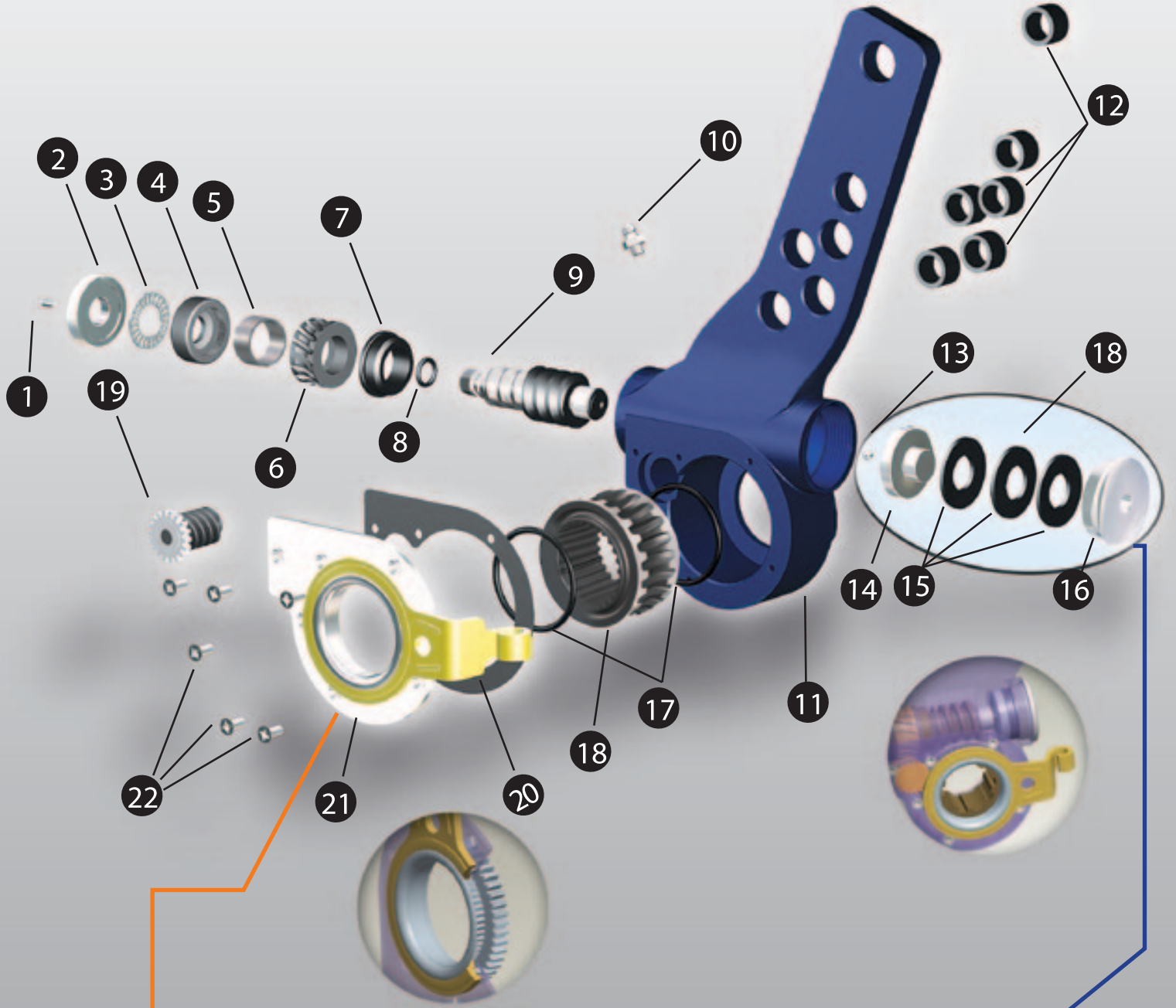

**Termination cases of
untightened control unit**
with improved control unit system

**Geliştirilmiş kapak sistemi ile
kapak kaçırmalarına son**

Steel disc springs which keeping
feature of spring tension, to
prevent breakings were made with
strengthened block and M38 plug.

Yay tansiyon özelliğini kaybetmeyen
çelik disk yaylar kırılmaları önlemek için
güçlendirilmiş bilyalı baskı takozu ve M38
tapa kullanılmıştır.

PART LIST PARÇA LİSTESİ

- 1 **Rivet /** Perçin
- 2 **M 38 plug /** M 38 tapa
- 3 **Trust bearing /** Rulman
- 4 **Cone clutch housing /** Tepe dişlisi
- 5 **Clutch spring /** Kavrama yayı
- 6 **Clutch gear /** Kavrama dişlisi
- 7 **Thrust bush /** Tapa
- 8 **O-ring /** O-ring
- 9 **Worm shaft /** Sonsuz mil
- 10 **Grease nipple /** Grasörlük
- 11 **Body /** Gövde
- 12 **Bush /** Burç
- 13 **Ball /** Bilya
- 14 **Coupling /** Kaplin
- 15 **Disc spring /** Disk yay
- 16 **M 38 torque plug /** M 38 tork tapası
- 17 **O-ring /** Oring
- 18 **Warm gear /** Sonsuz dişli
- 19 **Clutch screw /** Kavrama vidası
- 20 **Gasget /** Conta
- 21 **Control arm /** Kontrol kapağı
- 22 **Countersunk Screw /** Vida

PATENTED

Improved S-ABA(Self Setting) Automatic Brake Adjuster's locking arm can be installed in every position.

This feature eliminates alignment need during installation and ensure easy mounting. Furthermore eliminate improper operation of the brake adjuster due to incorrect installation.

Also many types are unified into one type. This situation increases productivity, decreases stock costs and ensure easy availability of the products in the market.

In this brake adjuster, the clutch which used for long times and its design proved in our Automatic Brake Adjusters was used. Thus performance and durability of the adjuster was increased.

Müşteri talepleri doğrultusunda geliştirmiş olduğumuz 180° kilit sacı açılı tam otomatik fren ayar kolunun kilit sacı, her açılmal pozisyonda takılabilir.



Bu özellik takma sırasında hizalama ihtiyacını ortadan kaldırarak montajı kolaylaştırır ve montaj hatalarından dolayı fren ayar kolunun uygun çalışmama olasılığını önler.

Tek tip fren ayar kolu pek çok fren ayar kolu tipi yerine kullanılabilirdiğinden, üretkenlikte artış, stok maliyetlerinde azalma ve ürünün pazarda kolayca bulunabilmesi sağlanır.

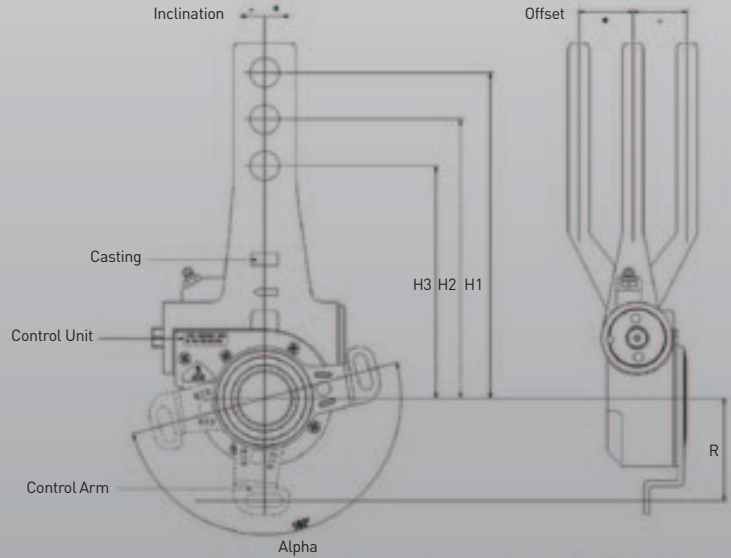

Bu fren ayar kolunda pazardaki diğer markalardan farklı olarak, otomatik fren ayar kollarımızda uzun yıllar kullanılan ve tasarımı ispatlanmış kavrama sistemi kullanılmıştır. Böylece fren ayar kolunun performansı ve dayanıklılığı artırılmıştır.



D-C

D-C		5018	A		5017	B		5016	C
		AYS CODE 800005			AYS CODE 800010			AYS CODE 800015	
		PART NUMBER 80000			PART NUMBER 80001			PART NUMBER 80008	
		OEM NO MER62043			OEM NO MER62044			OEM NO KB2855	
D-C		5015	D		5020	E		5019	F
		AYS CODE 800020			AYS CODE 800025			AYS CODE 800030	
		PART NUMBER 80009			PART NUMBER 80010			PART NUMBER 80011	
		OEM NO KB2145			OEM NO KB2140			OEM NO KB2135	
D-C		5032	G		5033	H		5031	I
		AYS CODE 800035			AYS CODE 800040			AYS CODE 800045	
		PART NUMBER 80012			PART NUMBER 80013			PART NUMBER 80014	
		OEM NO 4W3145			OEM NO 4W3150			OEM NO 9454200438	
D-C		5018	J		5027	K		5018	L
		AYS CODE 800090			AYS CODE 800095			AYS CODE 800330	
		PART NUMBER 80030			PART NUMBER 80031			PART NUMBER 80163	
		OEM NO 9454200938			OEM NO			OEM NO 9454201238	

	AYS CODE	CASTING	CONTROL UNIT	APPLICATION	SPLINE TEETH	NO of HOLE	H1	H2	H3	H4	H5	H6	H7	BUSHING (mm)	SPLINE TYPE	CONTROL ARM
A	800005	5018	527	D-C	26	1	145							14	N42x1,5x9H DIN 5480	double bent (short; R=65 mm)
B	800010	5017	527	D-C	26	1	145							14	N42x1,5x9H DIN 5480	double bent (short; R=65 mm)
C	800015	5016	528	D-C	26	1	145							14	N42x1,5x9H DIN 5480	double bent (medium; R=78 mm)
D	800020	5015	528	D-C	26	1	145							14	N42x1,5x9H DIN 5480	double bent (medium; R=78 mm)
E	800025	5020	527	D-C	26	1	145							14	N42x1,5x9H DIN 5480	double bent (short; R=65 mm)
F	800030	5019	527	D-C	26	1	145							14	N42x1,5x9H DIN 5480	double bent (short; R=65 mm)
G	800035	5032	527	D-C	26	1	145							14	N42x1,5x9H DIN 5480	double bent (short; R=65 mm)
H	800040	5033	527	D-C	26	1	145							14	N42x1,5x9H DIN 5480	double bent (short; R=65 mm)
I	800045	5031	527	D-C	26	1	145							14	N42x1,5x9H DIN 5480	double bent (short; R=65 mm)
J	800090	5018	527	D-C	26	1	145							14	N42x1,5x9H DIN 5480	double bent (short; R=65 mm)
K	800095	5027	532	D-C	28	3	180	155	130					12	SAE 1 1/2" 28 C	double bent (short; R=65 mm)
L	800330	5018	527	D-C	26	1	145							14	N42x1,5x9H DIN 5480	double bent (short; R=65 mm)













D-C	5017	A		AYS CODE 800335 PART NUMBER 80164 OEM NO 9454201338
D-C	5016	B		AYS CODE 800340 PART NUMBER 80165 OEM NO 9454201038
D-C	5015	C		AYS CODE 800345 PART NUMBER 80166 OEM NO 9454201138
D-C	5031	D		AYS CODE 800350 PART NUMBER 80167 OEM NO 9454201438
D-C	5018	E		AYS CODE 800355 PART NUMBER 80168 OEM NO 9454201538
D-C	5017	F		AYS CODE 800485 PART NUMBER 79137 OEM NO HB100047
D-C	5018	G		AYS CODE 800490 PART NUMBER 79136 OEM NO HB100046
D-C	8037	H		AYS CODE 801560 PART NUMBER 70706 OEM NO KB2440
D-C	8037	I		AYS CODE 801570 PART NUMBER 72213 OEM NO KB2130
D-C	8162	J		AYS CODE 801700 PART NUMBER 72456 OEM NO
D-C	8163	K		AYS CODE 801705 PART NUMBER 72455 OEM NO
D-C	8162	L		AYS CODE 801710 PART NUMBER 70991 OEM NO 4W3290

	AYS CODE	CASTING	CONTROL UNIT	APPLICATION	SPLINE TEETH	NO of HOLE	H1	H2	H3	H4	H5	H6	H7	BUSHING (mm)	SPLINE TYPE	CONTROL ARM
A	800335	5017	527	D-C	26	1	145							14	N42x1,5x9H DIN 5480	double bent (short; R=65 mm)
B	800340	5016	528	D-C	26	1	145							14	N42x1,5x9H DIN 5480	double bent (medium; R=78 mm)
C	800345	5015	528	D-C	26	1	145							14	N42x1,5x9H DIN 5480	double bent (medium; R=78 mm)
D	800350	5031	527	D-C	26	1	145							14	N42x1,5x9H DIN 5480	double bent (short; R=65 mm)
E	800355	5018	527	D-C	26	1	145							14	N42x1,5x9H DIN 5480	double bent (short; R=65 mm)
F	800485	5017	541	D-C	26	1	145							14	N42x1,5x9H DIN 5480	double bent (short; R=65 mm)
G	800490	5018	541	D-C	26	1	145							14	N42x1,5x9H DIN 5480	double bent (short; R=65 mm)
H	801560	8037	527	D-C	26	1	115							14	N42x1,5x9H DIN 5480	double bent (short; R=65 mm)
I	801570	8037	528	D-C	26	1	130							14	N42x1,5x9H DIN 5480	double bent (medium; R=78 mm)
J	801700	8162	527	D-C	26	1	130							14	N42x1,5x9H DIN 5480	double bent (short; R=65 mm)
K	801705	8163	527	D-C	26	1	130							14	N42x1,5x9H DIN 5480	double bent (short; R=65 mm)
L	801710	8162	527	D-C	26	1	145							14	N42x1,5x9H DIN 5480	double bent (short; R=65 mm)

D-C







D-C		8163	A		8162	B		8163
	AYS CODE 801715		AYS CODE 801720		AYS CODE 801725		AYS CODE 801725	
	PART NUMBER 70990		PART NUMBER 70753		PART NUMBER 70754		PART NUMBER 70754	
	OEM NO 4W3285		OEM NO KB2445		OEM NO KB2765		OEM NO KB2765	
D-C		8177	D		8177	E		8185
	AYS CODE 801735		AYS CODE 801740		AYS CODE 801795		AYS CODE 801795	
	PART NUMBER 70805		PART NUMBER 70954		PART NUMBER 70918		PART NUMBER 70918	
	OEM NO 3894200238		OEM NO KB2045		OEM NO KB2470		OEM NO KB2470	
D-C		8186	G		8185	H		8186
	AYS CODE 801800		AYS CODE 801825		AYS CODE 801830		AYS CODE 801830	
	PART NUMBER 70917		PART NUMBER 12170		PART NUMBER 12171		PART NUMBER 12171	
	OEM NO KB2840		OEM NO		OEM NO		OEM NO	
D-C		8202	J		8202	K		8860
	AYS CODE 801845		AYS CODE 801850		AYS CODE 802540		AYS CODE 802540	
	PART NUMBER 70870		PART NUMBER 70775		PART NUMBER 72060		PART NUMBER 72060	
	OEM NO 6234200938		OEM NO KB2100		OEM NO 4W3985		OEM NO 4W3985	

	AYS CODE	CASTING	CONTROL UNIT	APPLICATION	SPLINE TEETH	NO of HOLE	H1	H2	H3	H4	H5	H6	H7	BUSHING (mm)	SPLINE TYPE	CONTROL ARM
A	801715	8163	527	D-C	26	1	145							14	N42x1,5x9H DIN 5480	double bent (short; R=65 mm)
B	801720	8162	528	D-C	26	1	145							14	N42x1,5x9H DIN 5480	double bent (medium; R=78 mm)
C	801725	8163	528	D-C	26	1	145							14	N42x1,5x9H DIN 5480	double bent (medium; R=78 mm)
D	801735	8177	528	D-C	26	1	145							14	N42x1,5x9H DIN 5480	double bent (medium; R=78 mm)
E	801740	8177	527	D-C	26	1	145							14	N42x1,5x9H DIN 5480	double bent (short; R=65 mm)
F	801795	8185	545	D-C	26	1	145							14	N42x1,5x9H DIN 5480	double bent (short; R=65 mm)
G	801800	8186	543	D-C	26	1	145							14	N42x1,5x9H DIN 5480	straight
H	801825	8185	527	D-C	26	1	145							14	N42x1,5x9H DIN 5480	double bent (short; R=65 mm)
I	801830	8186	527	D-C	26	1	145							14	N42x1,5x9H DIN 5480	double bent (short; R=65 mm)
J	801845	8202	527	D-C	26	1	110							14	N42x1,5x9H DIN 5480	double bent (short; R=65 mm)
K	801850	8202	527	D-C	26	1	130							14	N42x1,5x9H DIN 5480	double bent (short; R=65 mm)
L	802540	8860	528	D-C	26	1	145							14	N42x1,5x9H DIN 5480	double bent (medium; R=78 mm)













D-C	8861	A		AYS CODE 802545	PART NUMBER 72061	OEM NO 4W3990
D-C	8900	B		AYS CODE 802575	PART NUMBER 72059	OEM NO KB2040
D-C	8900	C		AYS CODE 802580	PART NUMBER 72056	OEM NO 6234201838
MAN	5018	D		AYS CODE 800215	PART NUMBER 80084	OEM NO
MAN	5031	E		AYS CODE 800220	PART NUMBER 80086	OEM NO
MAN	5016	F		AYS CODE 800225	PART NUMBER 80087	OEM NO
MAN	5015	G		AYS CODE 800230	PART NUMBER 80088	OEM NO
MAN	5020	H		AYS CODE 800240	PART NUMBER 80092	OEM NO
MAN	5019	I		AYS CODE 800245	PART NUMBER 80093	OEM NO
MAN	5018	J		AYS CODE 800360	PART NUMBER 80176	OEM NO 81506106263
MAN	5017	K		AYS CODE 800365	PART NUMBER 80177	OEM NO 81506106264
MAN	5016	L		AYS CODE 800370	PART NUMBER 80178	OEM NO 81506106259

	AYS CODE	CASTING	CONTROL UNIT	APPLICATION	SPLINE TEETH	NO of HOLE	H1	H2	H3	H4	H5	H6	H7	BUSHING (mm)	SPLINE TYPE	CONTROL ARM
A	802545	8861	528	D-C	26	1	145							14	N42x1,5x9H DIN 5480	double bent (medium; R=78 mm)
B	802575	8900	527	D-C	26	1	145							14	N42x1,5x9H DIN 5480	double bent (short; R=65 mm)
C	802580	8900	528	D-C	26	1	145							14	N42x1,5x9H DIN 5480	double bent (medium; R=78 mm)
D	800215	5018	527	MAN	26	1	145							14	N42x1,5x12H DIN 5480	double bent (short; R=65 mm)
E	800220	5031	527	MAN	26	1	145							14	N42x1,5x12H DIN 5480	double bent (short; R=65 mm)
F	800225	5016	528	MAN	26	1	145							14	N42x1,5x12H DIN 5480	double bent (medium; R=78 mm)
G	800230	5015	528	MAN	26	1	145							14	N42x1,5x12H DIN 5480	double bent (medium; R=78 mm)
H	800240	5020	527	MAN	26	1	145							14	N42x1,5x9H DIN 5480	double bent (short; R=65 mm)
I	800245	5019	527	MAN	26	1	145							14	N42x1,5x9H DIN 5480	double bent (short; R=65 mm)
J	800360	5018	535	MAN	26	1	145							14	N42x1,5x12H DIN 5480	double bent (short; R=65 mm)
K	800365	5017	535	MAN	26	1	145							14	N42x1,5x12H DIN 5480	double bent (short; R=65 mm)
L	800370	5016	536	MAN	26	1	145							14	N42x1,5x12H DIN 5480	double bent (medium; R=78 mm)

MAN

MAN	5015	MAN	5020	MAN	5019
A		B		C	
	AYS CODE 800375		AYS CODE 800380		AYS CODE 800385
	PART NUMBER 80179		PART NUMBER 80180		PART NUMBER 80181
	OEM NO 81506106260		OEM NO 81506106261		OEM NO 81506106262
MAN	5031	MAN	5017	MAN	5018
D		E		F	
	AYS CODE 800390		AYS CODE 800495		AYS CODE 800500
	PART NUMBER 80183		PART NUMBER c.s.		PART NUMBER c.s.
	OEM NO 81506106266		OEM NO		OEM NO
MAN	5041	MAN	5041	MAN	8070
G		H		I	
	AYS CODE 800870		AYS CODE 800875		AYS CODE 801630
	PART NUMBER c.s.		PART NUMBER 72348		PART NUMBER 72508
	OEM NO		OEM NO		OEM NO
MAN	8071	MAN	8162	MAN	8163
J		K		L	
	AYS CODE 801635		AYS CODE 801700		AYS CODE 801705
	PART NUMBER 72509		PART NUMBER 72456		PART NUMBER 72455
	OEM NO		OEM NO		OEM NO

	AYS CODE	CASTING	CONTROL UNIT	APPLICATION	SPLINE TEETH	NO of HOLE	H1	H2	H3	H4	H5	H6	H7	BUSHING (mm)	SPLINE TYPE	CONTROL ARM
A	800375	5015	536	MAN	26	1	145							14	N42x1,5x12H DIN 5480	double bent (medium; R=78 mm)
B	800380	5020	537	MAN	26	1	145							14	N42x1,5x9H DIN 5480	double bent (short; R=65 mm)
C	800385	5019	537	MAN	26	1	145							14	N42x1,5x9H DIN 5480	double bent (short; R=65 mm)
D	800390	5031	535	MAN	26	1	145							14	N42x1,5x12H DIN 5480	double bent (short; R=65 mm)
E	800495	5017	529	MAN	26	1	145							14	N42x1,5x9H DIN 5480	bent
F	800500	5018	529	MAN	26	1	145							14	N42x1,5x9H DIN 5480	bent
G	800870	5041	541	MAN	26	1	130							14	N42x1,5x9H DIN 5480	double bent (short; R=65 mm)
H	800875	5041	527	MAN	26	1	130							14	N42x1,5x9H DIN 5480	double bent (short; R=65 mm)
I	801630	8070	527	MAN	26	1	215							14	N42x1,5x9H DIN 5480	double bent (short; R=65 mm)
J	801635	8071	527	MAN	26	1	215							14	N42x1,5x9H DIN 5480	double bent (short; R=65 mm)
K	801700	8162	527	MAN	26	1	130							14	N42x1,5x9H DIN 5480	double bent (short; R=65 mm)
L	801705	8163	527	MAN	26	1	130							14	N42x1,5x9H DIN 5480	double bent (short; R=65 mm)













MAN	8162	MAN	8163	MAN	8177
A		B		C	
	AYS CODE 801720		AYS CODE 801725		AYS CODE 801735
	PART NUMBER 70753		PART NUMBER 70754		PART NUMBER 70805
	OEM NO KB2445		OEM NO KB2765		OEM NO 3894200238
MAN	8185	MAN	8186	MAN	8900
D		E		F	
	AYS CODE 801805		AYS CODE 801810		AYS CODE 802585
	PART NUMBER 72303		PART NUMBER 72304		PART NUMBER 79608
	OEM NO		OEM NO		OEM NO
MAN	475-20000	MAN	475-20000	MAN	475-20000
G		H		I	
	AYS CODE 803415		AYS CODE 803425		AYS CODE 803430
	PART NUMBER 72438		PART NUMBER 72208		PART NUMBER c.s.
	OEM NO		OEM NO		OEM NO
SCANIA	5039	SCANIA	5040	SCANIA	5041
J		K		L	
	AYS CODE 800455		AYS CODE 800460		AYS CODE 800790
	PART NUMBER 72468		PART NUMBER 72469		PART NUMBER 70864
	OEM NO		OEM NO		OEM NO

	AYS CODE	CASTING	CONTROL UNIT	APPLICATION	SPLINE TEETH	NO of HOLE	H1	H2	H3	H4	H5	H6	H7	BUSHING (mm)	SPLINE TYPE	CONTROL ARM
A	801720	8162	528	MAN	26	1	145							14	N42x1,5x9H DIN 5480	double bent (medium; R=78 mm)
B	801725	8163	528	MAN	26	1	145							14	N42x1,5x9H DIN 5480	double bent (medium; R=78 mm)
C	801735	8177	528	MAN	26	1	145							14	N42x1,5x9H DIN 5480	double bent (medium; R=78 mm)
D	801805	8185	541	MAN	26	1	145							14	N42x1,5x9H DIN 5480	double bent (short; R=65 mm)
E	801810	8186	541	MAN	26	1	145							14	N42x1,5x9H DIN 5480	double bent (short; R=65 mm)
F	802585	8900	527	MAN	26	1	130							14	N42x1,5x12H DIN 5480	double bent (short; R=65 mm)
G	803415	475-20000	527	MAN	26	1	130							14	N42x1,5x9H DIN 5480	double bent (short; R=65 mm)
H	803425	475-20000	527	MAN	26	1	145							14	N42x1,5x9H DIN 5480	double bent (short; R=65 mm)
I	803430	475-20000	527	MAN	26	1	150							14	N42x1,5x9H DIN 5480	double bent (short; R=65 mm)
J	800455	5039	527	SCANIA	10	1	130							16	SAE 1 1/2" 10 C	double bent (short; R=65 mm)
K	800460	5040	527	SCANIA	10	1	130							16	SAE 1 1/2" 10 C	double bent (short; R=65 mm)
L	800790	5041	542	SCANIA	10	1	165							16	SAE 1 1/2" 10 C	double bent (long; R=100 mm)

SCANIA













SCANIA	5041	SCANIA	5044	SCANIA	5045
A		B		C	
	AYS CODE 800815		AYS CODE 800925		AYS CODE 800930
	PART NUMBER 70801		PART NUMBER 70668		PART NUMBER 70669
	OEM NO		OEM NO		OEM NO
SCANIA	5046	SCANIA	8083	SCANIA	8084
D		E		F	
	AYS CODE 801290		AYS CODE 801640		AYS CODE 801645
	PART NUMBER 79249		PART NUMBER 72995		PART NUMBER 72996
	OEM NO		OEM NO		OEM NO
SCANIA	8083	SCANIA	8084	SCANIA	8162
G		H		I	
	AYS CODE 801650		AYS CODE 801655		AYS CODE 801680
	PART NUMBER 72851		PART NUMBER 72852		PART NUMBER c.s.
	OEM NO		OEM NO		OEM NO
SCANIA	8162	SCANIA	8662	SCANIA	8663
J		K		L	
	AYS CODE 801685		AYS CODE 801855		AYS CODE 801860
	PART NUMBER c.s.		PART NUMBER 70878		PART NUMBER 70879
	OEM NO		OEM NO		OEM NO

	AYS CODE	CASTING	CONTROL UNIT	APPLICATION	SPLINE TEETH	NO of HOLE	H1	H2	H3	H4	H5	H6	H7	BUSHING (mm)	SPLINE TYPE	CONTROL ARM
A	800815	5041	542	SCANIA	10	1	180							16	SAE 1 1/2" 10 C	double bent (long; R=100 mm)
B	800925	5044	532	SCANIA	10	1	151							12,7	SAE 1 1/2" 10 C	double bent (short; R=65 mm)
C	800930	5045	532	SCANIA	10	1	151							12,7	SAE 1 1/2" 10 C	double bent (short; R=65 mm)
D	801290	5046	530	SCANIA	10	1	178							14	SAE 1 1/2" 10 C	ays-saddle type
E	801640	8083	541	SCANIA	10	1	165							16	SAE 1 1/2" 10 C	double bent (short; R=65 mm)
F	801645	8084	541	SCANIA	10	1	165							16	SAE 1 1/2" 10 C	double bent (short; R=65 mm)
G	801650	8083	527	SCANIA	10	1	165							16	SAE 1 1/2" 10 C	double bent (short; R=65 mm)
H	801655	8084	527	SCANIA	10	1	165							16	SAE 1 1/2" 10 C	double bent (short; R=65 mm)
I	801680	8162	527	SCANIA	10	1	130							16	SAE 1 1/2" 10 C	double bent (short; R=65 mm)
J	801685	8162	527	SCANIA	10	1	145							16	SAE 1 1/2" 10 C	double bent (short; R=65 mm)
K	801855	8662	540	SCANIA	10	1	165							16	SAE 1 1/2" 10 C	double bent (long; R=100 mm)
L	801860	8663	540	SCANIA	10	1	165							16	SAE 1 1/2" 10 C	double bent (long; R=100 mm)



SCANIA	8704	SCANIA	8705	SCANIA	8704
A		B		C	
	AYS CODE 801875		AYS CODE 801880		AYS CODE 801895
	PART NUMBER c.s.		PART NUMBER c.s.		PART NUMBER 72621
	OEM NO		OEM NO		OEM NO
SCANIA	8705	SCANIA	8704	SCANIA	8705
D		E		F	
	AYS CODE 801900		AYS CODE 801905		AYS CODE 801910
	PART NUMBER 72620		PART NUMBER 70938		PART NUMBER 70937
	OEM NO		OEM NO		OEM NO
SCANIA	8985	SCANIA	8987	SCANIA	475-20000
G		H		I	
	AYS CODE 802660		AYS CODE 802665		AYS CODE 802855
	PART NUMBER 70663		PART NUMBER 70662		PART NUMBER 72009
	OEM NO		OEM NO		OEM NO
SCANIA	475-20000	SCANIA	475-20000	DAF	5041
J		K		L	
	AYS CODE 803075		AYS CODE 803185		AYS CODE 800750
	PART NUMBER 70661		PART NUMBER 72249		PART NUMBER 70871
	OEM NO		OEM NO 633107720		OEM NO 4W2005

	AYS CODE	CASTING	CONTROL UNIT	APPLICATION	SPLINE TEETH	NO of HOLE	H1	H2	H3	H4	H5	H6	H7	BUSHING (mm)	SPLINE TYPE	CONTROL ARM
A	801875	8704	527	SCANIA	10	1	165							14	SAE 1 1/2" 10 C	double bent (short; R=65 mm)
B	801880	8705	527	SCANIA	10	1	165							14	SAE 1 1/2" 10 C	double bent (short; R=65 mm)
C	801895	8704	527	SCANIA	10	1	165							16	SAE 1 1/2" 10 C	double bent (short; R=65 mm)
D	801900	8705	527	SCANIA	10	1	165							16	SAE 1 1/2" 10 C	double bent (short; R=65 mm)
E	801905	8704	532	SCANIA	10	1	165							16	SAE 1 1/2" 10 C	double bent (short; R=65 mm)
F	801910	8705	532	SCANIA	10	1	165							16	SAE 1 1/2" 10 C	double bent (short; R=65 mm)
G	802660	8985	542	SCANIA	10	1	165							16	SAE 1 1/2" 10 C	double bent (long; R=100 mm)
H	802665	8987	542	SCANIA	10	1	165							16	SAE 1 1/2" 10 C	double bent (long; R=100 mm)
I	802855	475-20000	542	SCANIA	10	1	130							16	SAE 1 1/2" 10 C	double bent (long; R=100 mm)
J	803075	475-20000	540	SCANIA	10	1	165							16	SAE 1 1/2" 10 C	double bent (long; R=100 mm)
K	803185	475-20000	529	SCANIA	10	4	203	178	152	127				14	SAE 1 1/2" 10 C	bent
L	800750	5041	529	DAF	10	1	140							14	SAE 1 1/2" 10 C	bent

DAF











DAF	5041	DAF	5041	DAF	5041
A		B		C	
	AYS CODE 800755		AYS CODE 800765		AYS CODE 800775
	PART NUMBER 72117		PART NUMBER 72558		PART NUMBER C.S.
	OEM NO		OEM NO 537537		OEM NO
DAF	5041	DAF	5041	DAF	5046
D		E		F	
	AYS CODE 800780		AYS CODE 800785		AYS CODE 801280
	PART NUMBER 72309		PART NUMBER 72540		PART NUMBER 72833
	OEM NO		OEM NO KB2305		OEM NO 4W3975
DAF	5047	DAF	8042	DAF	8043
G		H		I	
	AYS CODE 801285		AYS CODE 801580		AYS CODE 801585
	PART NUMBER 72834		PART NUMBER 79179		PART NUMBER 79180
	OEM NO 4W3980		OEM NO 1309074		OEM NO 1309075
DAF	8042	DAF	8043	DAF	8185
J		K		L	
	AYS CODE 801590		AYS CODE 801595		AYS CODE 801755
	PART NUMBER 72302		PART NUMBER 72301		PART NUMBER 72312
	OEM NO		OEM NO		OEM NO

	AYS CODE	CASTING	CONTROL UNIT	APPLICATION	SPLINE TEETH	NO of HOLE	H1	H2	H3	H4	H5	H6	H7	BUSHING (mm)	SPLINE TYPE	CONTROL ARM
A	800755	5041	528	DAF	10	1	140							14	SAE 1 1/2" 10 C	double bent (medium; R=78 mm)
B	800765	5041	540	DAF	10	1	140							14	SAE 1 1/2" 10 C	double bent (long; R=100 mm)
C	800775	5041	540	DAF	10	1	165							14	SAE 1 1/2" 10 C	double bent (long; R=100 mm)
D	800780	5041	527	DAF	10	1	165							14	SAE 1 1/2" 10 C	double bent (short; R=65 mm)
E	800785	5041	528	DAF	10	1	165							14	SAE 1 1/2" 10 C	double bent (medium; R=78 mm)
F	801280	5046	528	DAF	10	1	165							14	SAE 1 1/2" 10 C	double bent (medium; R=78 mm)
G	801285	5047	528	DAF	10	1	165							14	SAE 1 1/2" 10 C	double bent (medium; R=78 mm)
H	801580	8042	527	DAF	10	1	145							14	SAE 1 1/2" 10 C	double bent (short; R=65 mm)
I	801585	8043	527	DAF	10	1	145							14	SAE 1 1/2" 10 C	double bent (short; R=65 mm)
J	801590	8042	527	DAF	10	1	165							14	SAE 1 1/2" 10 C	double bent (short; R=65 mm)
K	801595	8043	527	DAF	10	1	165							14	SAE 1 1/2" 10 C	double bent (short; R=65 mm)
L	801755	8185	527	DAF	10	1	143							14	SAE 1 1/2" 10 C	double bent (short; R=65 mm)

DAF	8186	DAF	8185	DAF	8186
A	AYS CODE 801760	B	AYS CODE 801815	C	AYS CODE 801820
	PART NUMBER 72313		PART NUMBER 72528		PART NUMBER 72527
	OEM NO		OEM NO		OEM NO 279234
DAF	8760	DAF	8761	DAF	8760
D	AYS CODE 802050	E	AYS CODE 802055	F	AYS CODE 802080
	PART NUMBER 72107		PART NUMBER 72108		PART NUMBER 72815
	OEM NO		OEM NO		OEM NO R9640/F
DAF	8761	DAF	8760	DAF	8761
G	AYS CODE 802085	H	AYS CODE 802090	I	AYS CODE 802095
	PART NUMBER 72816		PART NUMBER 10868		PART NUMBER 10869
	OEM NO R9641/F		OEM NO 9007808		OEM NO 9007807
DAF	8760	DAF	8761	DAF	8760
J	AYS CODE 802190	K	AYS CODE 802195	L	AYS CODE 802200
	PART NUMBER 72150		PART NUMBER 72151		PART NUMBER 72532
	OEM NO 7955/F		OEM NO 7956/F		OEM NO 0092419

	AYS CODE	CASTING	CONTROL UNIT	APPLICATION	SPLINE TEETH	NO of HOLE	H1	H2	H3	H4	H5	H6	H7	BUSHING (mm)	SPLINE TYPE	CONTROL ARM
A	801760	8186	527	DAF	10	1	143							14	SAE 1 1/2" 10 C	double bent (short; R=65 mm)
B	801815	8185	527	DAF	26	1	143							14	N42x1,5x9H DIN 5480	double bent (short; R=65 mm)
C	801820	8186	527	DAF	26	1	143							14	N42x1,5x9H DIN 5480	double bent (short; R=65 mm)
D	802050	8760	528	DAF	10	1	140							14	SAE 1 1/2" 10 C	double bent (medium; R=78 mm)
E	802055	8761	528	DAF	10	1	140							14	SAE 1 1/2" 10 C	double bent (medium; R=78 mm)
F	802080	8760	529	DAF	10	1	140							14	SAE 1 1/2" 10 C	bent
G	802085	8761	529	DAF	10	1	140							14	SAE 1 1/2" 10 C	bent
H	802090	8760	529	DAF	10	1	140							14	SAE 1 1/2" 10 C	bent
I	802095	8761	529	DAF	10	1	140							14	SAE 1 1/2" 10 C	bent
J	802190	8760	528	DAF	10	1	165							14	SAE 1 1/2" 10 C	double bent (medium; R=78 mm)
K	802195	8761	528	DAF	10	1	165							14	SAE 1 1/2" 10 C	double bent (medium; R=78 mm)
L	802200	8760	528	DAF	10	1	165							14	SAE 1 1/2" 10 C	double bent (medium; R=78 mm)

DAF





DAF	8761	8761	8985	8985	8987	
A		AYS CODE 802205	B		C	
		PART NUMBER 72533				
		OEM NO 0092420				
DAF	8985	8985	8987	8987	475-20000	
D		AYS CODE 802640	E		F	
		PART NUMBER 72311				
		OEM NO				
DAF	475-20000	475-20000	475-20000	475-20000	475-20000	
G		AYS CODE 802920	H		I	
		PART NUMBER 72197				
		OEM NO				
DAF	475-20000	475-20000	475-20000	475-20000	475-20000	
J		AYS CODE 802960	K		L	
		PART NUMBER c.s.				
		OEM NO				

	AYS CODE	CASTING	CONTROL UNIT	APPLICATION	SPLINE TEETH	NO of HOLE	H1	H2	H3	H4	H5	H6	H7	BUSHING (mm)	SPLINE TYPE	CONTROL ARM
A	802205	8761	528	DAF	10	1	165							14	SAE 1 1/2" 10 C	double bent (medium; R=78 mm)
B	802590	8985	527	DAF	10	1	140							14	SAE 1 1/2" 10 C	double bent (short; R=65 mm)
C	802595	8987	527	DAF	10	1	140							14	SAE 1 1/2" 10 C	double bent (short; R=65 mm)
D	802640	8985	527	DAF	10	1	165							14	SAE 1 1/2" 10 C	double bent (short; R=65 mm)
E	802645	8987	527	DAF	10	1	165							14	SAE 1 1/2" 10 C	double bent (short; R=65 mm)
F	802915	475-20000	529	DAF	10	1	140							12,7	SAE 1 1/2" 10 C	bent
G	802920	475-20000	528	DAF	10	1	140							14	SAE 1 1/2" 10 C	double bent (medium; R=78 mm)
H	802925	475-20000	529	DAF	10	1	140							14	SAE 1 1/2" 10 C	bent
I	802930	475-20000	527	DAF	10	1	140							x	SAE 1 1/2" 10 C	double bent (short; R=65 mm)
J	802960	475-20000	529	DAF	10	1	150							14	SAE 1 1/2" 10 C	bent
K	803085	475-20000	527	DAF	10	1	165							x	SAE 1 1/2" 10 C	double bent (short; R=65 mm)
L	803290	475-20000	527	DAF	19	1	152							14	A38x34 DIN 5482	double bent (short; R=65 mm)





DAF	475-20000	SISU	5046	SISU	5047
A		B		C	
	AYS CODE 803420		AYS CODE 801210		AYS CODE 801215
	PART NUMBER 72529		PART NUMBER 79068		PART NUMBER 79069
	OEM NO 279244		OEM NO		OEM NO
SISU	5046	SISU	5047	SISU	8185
D		E		F	
	AYS CODE 801270		AYS CODE 801275		AYS CODE 801745
	PART NUMBER 79639		PART NUMBER 79640		PART NUMBER 72521
	OEM NO 5465303511		OEM NO 5465303521		OEM NO 1465300911
SISU	8186	SISU	8185	SISU	8186
G		H		I	
	AYS CODE 801750		AYS CODE 801825		AYS CODE 801830
	PART NUMBER 72522		PART NUMBER 12170		PART NUMBER 12171
	OEM NO 1465300921		OEM NO		OEM NO
SISU	8717	SISU	8718	SISU	8717
J		K		L	
	AYS CODE 801915		AYS CODE 801920		AYS CODE 801935
	PART NUMBER 79394		PART NUMBER 79395		PART NUMBER 79407
	OEM NO 665465303211		OEM NO 665465303221		OEM NO 5465303111

	AYS CODE	CASTING	CONTROL UNIT	APPLICATION	SPLINE TEETH	NO of HOLE	H1	H2	H3	H4	H5	H6	H7	BUSHING (mm)	SPLINE TYPE	CONTROL ARM
A	803420	475-20000	527	DAF	26	1	140							x	N42x1,5x9H DIN 5480	double bent (short; R=65 mm)
B	801210	5046	541	SISU	10	1	145							14	SAE 1 1/2" 10 C	double bent (short; R=65 mm)
C	801215	5047	541	SISU	10	1	145							14	SAE 1 1/2" 10 C	double bent (short; R=65 mm)
D	801270	5046	540	SISU	10	1	165							14	SAE 1 1/2" 10 C	double bent (long; R=100 mm)
E	801275	5047	540	SISU	10	1	165							14	SAE 1 1/2" 10 C	double bent (long; R=100 mm)
F	801745	8185	540	SISU	10	1	145							14	SAE 1 1/2" 10 C	double bent (long; R=100 mm)
G	801750	8186	540	SISU	10	1	145							14	SAE 1 1/2" 10 C	double bent (long; R=100 mm)
H	801825	8185	527	SISU	26	1	145							14	N42x1,5x9H DIN 5480	double bent (short; R=65 mm)
I	801830	8186	527	SISU	26	1	145							14	N42x1,5x9H DIN 5480	double bent (short; R=65 mm)
J	801915	8717	540	SISU	10	1	165							14	SAE 1 1/2" 10 C	double bent (long; R=100 mm)
K	801920	8718	540	SISU	10	1	165							14	SAE 1 1/2" 10 C	double bent (long; R=100 mm)
L	801935	8717	527	SISU	26	1	165							14	N42x1,5x9H DIN 5480	double bent (short; R=65 mm)

SISU / VOLVO





SISU	8718	SISU	475-20000	SISU	475-20000
A		B		C	
	AYS CODE 801940		AYS CODE 802635		AYS CODE 802890
	PART NUMBER 79408		PART NUMBER 79372		PART NUMBER 70851
	OEM NO 5465303121		OEM NO 5465301811		OEM NO 1465300151
SISU	475-20000	SISU	475-20000	SISU	475-20000
D		E		F	
	AYS CODE 802935		AYS CODE 803065		AYS CODE 803290
	PART NUMBER 72428		PART NUMBER 79501		PART NUMBER 72330
	OEM NO 661465300611		OEM NO 5465303311		OEM NO 4W2960
SISU	5027	SISU	5027	VOLVO	5039
G		H		I	
	AYS CODE 803645		AYS CODE 803650		AYS CODE 800445
	PART NUMBER 79643		PART NUMBER 72260		PART NUMBER
	OEM NO 5465303611		OEM NO 72095		OEM NO
VOLVO	5040	VOLVO	5037	VOLVO	5038
J		K		L	
	AYS CODE 800450		AYS CODE 800515		AYS CODE 800520
	PART NUMBER		PART NUMBER 70572		PART NUMBER 70571
	OEM NO		OEM NO 6970/F		OEM NO 6969/F

	AYS CODE	CASTING	CONTROL UNIT	APPLICATION	SPLINE TEETH	NO of HOLE	H1	H2	H3	H4	H5	H6	H7	BUSHING (mm)	SPLINE TYPE	CONTROL ARM
A	801940	8718	527	SISU	26	1	165							14	N42x1,5x9H DIN 5480	double bent (short; R=65 mm)
B	802635	475-20000	541	SISU	26	1	145							14	N42x1,5x9H DIN 5480	double bent (short; R=65 mm)
C	802890	475-20000	527	SISU	10	1	140							12,7	SAE 1 1/2" 10 C	double bent (short; R=65 mm)
D	802935	475-20000	541	SISU	10	1	145							14	SAE 1 1/2" 10 C	double bent (short; R=65 mm)
E	803065	475-20000	527	SISU	10	1	165							14	SAE 1 1/2" 10 C	double bent (short; R=65 mm)
F	803290	475-20000	527	SISU	19	1	152							14	A38x34 DIN 5482	double bent (short; R=65 mm)
G	803645	5027	541	SISU	10	5	215	181	153	129	105			14	SAE 1 1/2" 10 C	double bent (short; R=65 mm)
H	803650	5027	529	SISU	10	5	215	181	153	129	105			14	SAE 1 1/2" 10 C	bent
I	800445	5039	540	VOLVO	10	1	145							12,7	SAE 1 1/2" 10 C	double bent (long; R=100 mm)
J	800450	5040	540	VOLVO	10	1	145							12,7	SAE 1 1/2" 10 C	double bent (long; R=100 mm)
K	800515	5037	529	VOLVO	10	1	140							12,7	SAE 1 1/2" 10 C	bent
L	800520	5038	529	VOLVO	10	1	140							12,7	SAE 1 1/2" 10 C	bent











VOLVO	5039	VOLVO	5040	VOLVO	5041
A		B		C	
	AYS CODE 800675		AYS CODE 800680		AYS CODE 800715
	PART NUMBER 79359		PART NUMBER 79360		PART NUMBER 79464
	OEM NO 9524856		OEM NO 9524857		OEM NO
VOLVO	5041	VOLVO	5046	VOLVO	5047
D		E		F	
	AYS CODE 800740		AYS CODE 801220		AYS CODE 801225
	PART NUMBER 79161		PART NUMBER 70705		PART NUMBER 79697
	OEM NO		OEM NO		OEM NO 1581481
VOLVO	5046	VOLVO	5047	VOLVO	8704
G		H		I	
	AYS CODE 801320		AYS CODE 801325		AYS CODE 801865
	PART NUMBER 79190		PART NUMBER 79191		PART NUMBER 79275
	OEM NO		OEM NO		OEM NO
VOLVO	8705	VOLVO	8760	VOLVO	8761
J		K		L	
	AYS CODE 801870		AYS CODE 802070		AYS CODE 802075
	PART NUMBER 79276		PART NUMBER 70649		PART NUMBER 70648
	OEM NO		OEM NO		OEM NO

	AYS CODE	CASTING	CONTROL UNIT	APPLICATION	SPLINE TEETH	NO of HOLE	H1	H2	H3	H4	H5	H6	H7	BUSHING (mm)	SPLINE TYPE	CONTROL ARM
A	800675	5039	542	VOLVO	10	1	145							12,7	SAE 1 1/2" 10 C	double bent (long; R=100 mm)
B	800680	5040	542	VOLVO	10	1	145							12,7	SAE 1 1/2" 10 C	double bent (long; R=100 mm)
C	800715	5041	529	VOLVO	10	1	125							12,7	SAE 1 1/2" 10 C	bent
D	800740	5041	542	VOLVO	10	1	140							12,7	SAE 1 1/2" 10 C	double bent (long; R=100 mm)
E	801220	5046	529	VOLVO	10	1	152							16	SAE 1 1/2" 10 C	bent
F	801225	5047	529	VOLVO	10	1	152							16	SAE 1 1/2" 10 C	bent
G	801320	5046	529	VOLVO	10	1	185							12,7	SAE 1 1/2" 10 C	bent
H	801325	5047	529	VOLVO	10	1	185							12,7	SAE 1 1/2" 10 C	bent
I	801865	8704	542	VOLVO	10	1	165							12,7	SAE 1 1/2" 10 C	double bent (long; R=100 mm)
J	801870	8705	542	VOLVO	10	1	165							12,7	SAE 1 1/2" 10 C	double bent (long; R=100 mm)
K	802070	8760	529	VOLVO	10	1	140							12,7	SAE 1 1/2" 10 C	bent
L	802075	8761	529	VOLVO	10	1	140							12,7	SAE 1 1/2" 10 C	bent

VOLVO













VOLVO	8760	VOLVO	8761	VOLVO	8760
A		B		C	
	AYS CODE 802130		AYS CODE 802135		AYS CODE 802140
	PART NUMBER 70647		PART NUMBER 70646		PART NUMBER 70977
	OEM NO		OEM NO		OEM NO 4W2485
VOLVO	8761	VOLVO	8760	VOLVO	8760
D		E		F	
	AYS CODE 802145		AYS CODE 802220		AYS CODE 802225
	PART NUMBER 70978		PART NUMBER 72914		PART NUMBER 70782
	OEM NO 4W2490		OEM NO 1581491		OEM NO
VOLVO	8760	VOLVO	8761	VOLVO	8860
G		H		I	
	AYS CODE 802320		AYS CODE 802325		AYS CODE 802490
	PART NUMBER 70641		PART NUMBER 70642		PART NUMBER 70910
	OEM NO 1581479		OEM NO 1581478		OEM NO
VOLVO	8861	VOLVO	8860	VOLVO	8861
J		K		L	
	AYS CODE 802495		AYS CODE 802520		AYS CODE 802525
	PART NUMBER 70909		PART NUMBER 72153		PART NUMBER 72152
	OEM NO		OEM NO		OEM NO

	AYS CODE	CASTING	CONTROL UNIT	APPLICATION	SPLINE TEETH	NO of HOLE	H1	H2	H3	H4	H5	H6	H7	BUSHING (mm)	SPLINE TYPE	CONTROL ARM
A	802130	8760	529	VOLVO	10	1	152							12,7	SAE 1 1/2" 10 C	bent
B	802135	8761	529	VOLVO	10	1	152							12,7	SAE 1 1/2" 10 C	bent
C	802140	8760	542	VOLVO	10	1	152							12,7	SAE 1 1/2" 10 C	double bent (long; R=100 mm)
D	802145	8761	542	VOLVO	10	1	152							12,7	SAE 1 1/2" 10 C	double bent (long; R=100 mm)
E	802220	8760	529	VOLVO	10	1	165							12,7	SAE 1 1/2" 10 C	bent
F	802225	8760	529	VOLVO	10	1	165							12,7	SAE 1 1/2" 10 C	bent
G	802320	8760	529	VOLVO	10	3	205	165	140					12,7	SAE 1 1/2" 10 C	bent
H	802325	8761	529	VOLVO	10	3	205	165	140					12,7	SAE 1 1/2" 10 C	bent
I	802490	8860	529	VOLVO	10	1	134							12,7	SAE 1 1/2" 10 C	bent
J	802495	8861	529	VOLVO	10	1	134							12,7	SAE 1 1/2" 10 C	bent
K	802520	8860	529	VOLVO	10	1	145							12,7	SAE 1 1/2" 10 C	bent
L	802525	8861	529	VOLVO	10	1	145							12,7	SAE 1 1/2" 10 C	bent













VOLVO	8985	VOLVO	8987	VOLVO	8985
A		B		C	
	AYS CODE 802600		AYS CODE 802605		AYS CODE 802610
	PART NUMBER 70832		PART NUMBER 70833		PART NUMBER 70922
	OEM NO KB2450		OEM NO KB2455		OEM NO
VOLVO	8987	VOLVO	8985	VOLVO	8987
D		E		F	
	AYS CODE 802615		AYS CODE 802620		AYS CODE 802625
	PART NUMBER 70921		PART NUMBER 70924		PART NUMBER 70923
	OEM NO		OEM NO		OEM NO
VOLVO	8987	VOLVO	475-20000	VOLVO	475-20000
G		H		I	
	AYS CODE 802630		AYS CODE 802760		AYS CODE 802840
	PART NUMBER c.s.		PART NUMBER 72085		PART NUMBER 70740
	OEM NO		OEM NO 4W3500		OEM NO
VOLVO	475-20000	VOLVO	475-20000	VOLVO	475-20000
J		K		L	
	AYS CODE 802845		AYS CODE 802850		AYS CODE 802880
	PART NUMBER 72246		PART NUMBER 72011		PART NUMBER 72166
	OEM NO		OEM NO		OEM NO

	AYS CODE	CASTING	CONTROL UNIT	APPLICATION	SPLINE TEETH	NO of HOLE	H1	H2	H3	H4	H5	H6	H7	BUSHING (mm)	SPLINE TYPE	CONTROL ARM
A	802600	8985	542	VOLVO	10	1	147							12,7	SAE 1 1/2" 10 C	double bent (long; R=100 mm)
B	802605	8987	542	VOLVO	10	1	147							12,7	SAE 1 1/2" 10 C	double bent (long; R=100 mm)
C	802610	8985	529	VOLVO	10	1	151							12,7	SAE 1 1/2" 10 C	bent
D	802615	8987	529	VOLVO	10	1	151							12,7	SAE 1 1/2" 10 C	bent
E	802620	8985	529	VOLVO	10	1	165							12,7	SAE 1 1/2" 10 C	bent
F	802625	8987	529	VOLVO	10	1	165							12,7	SAE 1 1/2" 10 C	bent
G	802630	8987	542	VOLVO	10	1	165							14	SAE 1 1/2" 10 C	double bent (long; R=100 mm)
H	802760	475-20000	529	VOLVO	10	1	133							12,7	SAE 1 1/2" 10 C	bent
I	802840	475-20000	529	VOLVO	10	1	127							12,7	SAE 1 1/2" 10 C	bent
J	802845	475-20000	529	VOLVO	10	1	127							12,7	SAE 1 1/2" 10 C	bent
K	802850	475-20000	529	VOLVO	10	1	127							14	SAE 1 1/2" 10 C	bent
L	802880	475-20000	542	VOLVO	10	1	140							12,7	SAE 1 1/2" 10 C	double bent (long; R=100 mm)

VOLVO / RENAULT

VOLVO	475-20000	VOLVO	475-20000	VOLVO	475-20000
A		B		C	
	AYS CODE 802915		AYS CODE 802940		AYS CODE 802960
	PART NUMBER 70946		PART NUMBER 72517		PART NUMBER C.S.
	OEM NO 1587482		OEM NO 11049395		OEM NO
VOLVO	475-20000	VOLVO	475-20000	VOLVO	475-20000
D		E		F	
	AYS CODE 802970		AYS CODE 802980		AYS CODE 802990
	PART NUMBER 72570		PART NUMBER 72167		PART NUMBER 70941
	OEM NO		OEM NO		OEM NO
VOLVO	475-20000	VOLVO	475-20000	VOLVO	475-20000
G		H		I	
	AYS CODE 802995		AYS CODE 803015		AYS CODE 803070
	PART NUMBER 72126		PART NUMBER 70703		PART NUMBER 72464
	OEM NO		OEM NO		OEM NO
VOLVO	475-20000	VOLVO	475-20000	RENAULT	5044
J		K		L	
	AYS CODE 803080		AYS CODE 803445		AYS CODE 801035
	PART NUMBER 70598		PART NUMBER 70932		PART NUMBER 72137
	OEM NO		OEM NO 4737789		OEM NO 5000504467

	AYS CODE	CASTING	CONTROL UNIT	APPLICATION	SPLINE TEETH	NO of HOLE	H1	H2	H3	H4	H5	H6	H7	BUSHING (mm)	SPLINE TYPE	CONTROL ARM
A	802915	475-20000	529	VOLVO	10	1	140							12,7	SAE 1 1/2" 10 C	bent
B	802940	475-20000	529	VOLVO	10	1	145							12,7	SAE 1 1/2" 10 C	bent
C	802960	475-20000	529	VOLVO	10	1	150							14	SAE 1 1/2" 10 C	bent
D	802970	475-20000	529	VOLVO	10	1	150							14	SAE 1 1/2" 10 C	bent
E	802980	475-20000	542	VOLVO	10	1	152							12,7	SAE 1 1/2" 10 C	double bent (long; R=100 mm)
F	802990	475-20000	529	VOLVO	10	1	152							12,7	SAE 1 1/2" 10 C	bent
G	802995	475-20000	529	VOLVO	10	1	152							12,7	SAE 1 1/2" 10 C	bent
H	803015	475-20000	529	VOLVO	10	1	152							16	SAE 1 1/2" 10 C	bent
I	803070	475-20000	542	VOLVO	10	2	165	140						16	SAE 1 1/2" 10 C	double bent (long; R=100 mm)
J	803080	475-20000	529	VOLVO	10	1	165							16	SAE 1 1/2" 10 C	bent
K	803445	475-20000	527	VOLVO	26	1	165							12,7	N42x1,5x9H DIN 5480	double bent (short; R=65 mm)
L	801035	5044	528	RENAULT	19	1	170							14	A38x34 DIN 5482	double bent (medium; R=78 mm)

RENAULT	5045	RENAULT	5046	RENAULT	5047
A		B		C	
AYS CODE 801040	AYS CODE 801470	AYS CODE 801475	AYS CODE 801490	AYS CODE 801495	AYS CODE 801500
PART NUMBER 72138	PART NUMBER 70621	PART NUMBER 70622	PART NUMBER 72738	PART NUMBER 72739	PART NUMBER 79256
OEM NO 5000504468	OEM NO 5000037954	OEM NO 5000037955	OEM NO	OEM NO	OEM NO
RENAULT	8008	RENAULT	8009	RENAULT	8008
D		E		F	
AYS CODE 801490	AYS CODE 801495	AYS CODE 801500	AYS CODE 801505	AYS CODE 801510	AYS CODE 801515
PART NUMBER 72738	PART NUMBER 72739	PART NUMBER 79257	PART NUMBER 72162	PART NUMBER 72163	PART NUMBER 72163
OEM NO	OEM NO	OEM NO	OEM NO	OEM NO	OEM NO
RENAULT	8009	RENAULT	8008	RENAULT	8009
G		H		I	
AYS CODE 801505	AYS CODE 801510	AYS CODE 801515	AYS CODE 801520	AYS CODE 801525	AYS CODE 801530
PART NUMBER 79257	PART NUMBER 72162	PART NUMBER 72163	PART NUMBER 72160	PART NUMBER 72161	PART NUMBER 79312
OEM NO	OEM NO	OEM NO	OEM NO	OEM NO	OEM NO 4W3850
RENAULT	8008	RENAULT	8009	RENAULT	8008
J		K		L	
AYS CODE 801520	AYS CODE 801525	AYS CODE 801530	AYS CODE 801520	AYS CODE 801525	AYS CODE 801530
PART NUMBER 72160	PART NUMBER 72161	PART NUMBER 79312	PART NUMBER 72160	PART NUMBER 72161	PART NUMBER 79312
OEM NO	OEM NO	OEM NO 4W3850	OEM NO	OEM NO	OEM NO 4W3850

	AYS CODE	CASTING	CONTROL UNIT	APPLICATION	SPLINE TEETH	NO of HOLE	H1	H2	H3	H4	H5	H6	H7	BUSHING (mm)	SPLINE TYPE	CONTROL ARM
A	801040	5045	528	RENAULT	19	1	170							14	A38x34 DIN 5482	double bent (medium; R=78 mm)
B	801470	5046	529	RENAULT	27	1	190							14	BNA 227	bent
C	801475	5047	529	RENAULT	27	1	190							14	BNA 227	bent
D	801490	8008	527	RENAULT	27	1	160							14	BNA 227, Ø 35,0	double bent (short; R=65 mm)
E	801495	8009	527	RENAULT	27	1	160							14	BNA 227, Ø 35,0	double bent (short; R=65 mm)
F	801500	8008	541	RENAULT	27	1	160							14	BNA 227, Ø 35,0	double bent (short; R=65 mm)
G	801505	8009	541	RENAULT	27	1	160							14	BNA 227, Ø 35,0	double bent (short; R=65 mm)
H	801510	8008	541	RENAULT	27	1	175							14	BNA 227, Ø 35,0	double bent (short; R=65 mm)
I	801515	8009	541	RENAULT	27	1	175							14	BNA 227, Ø 35,0	double bent (short; R=65 mm)
J	801520	8008	527	RENAULT	27	1	175							14	BNA 227, Ø 35,0	double bent (short; R=65 mm)
K	801525	8009	527	RENAULT	27	1	175							14	BNA 227, Ø 35,0	double bent (short; R=65 mm)
L	801530	8008	527	RENAULT	27	1	175							14	BNA 227, Ø 35,0	double bent (short; R=65 mm)

RENAULT





RENAULT	8009	RENAULT	8008	RENAULT	8009
A		B		C	
	AYS CODE 801535		AYS CODE 801540		AYS CODE 801545
	PART NUMBER 79313		PART NUMBER 72005		PART NUMBER 72006
	OEM NO 4W3855		OEM NO		OEM NO
RENAULT	8008	RENAULT	8009	RENAULT	8717
D		E		F	
	AYS CODE 801550		AYS CODE 801555		AYS CODE 801955
	PART NUMBER 72089		PART NUMBER 72090		PART NUMBER 79310
	OEM NO		OEM NO		OEM NO SPK/1262B
RENAULT	8718	RENAULT	8717	RENAULT	8718
G		H		I	
	AYS CODE 801960		AYS CODE 801965		AYS CODE 801970
	PART NUMBER 79311		PART NUMBER 79308		PART NUMBER 79309
	OEM NO HB100394		OEM NO 4W3055		OEM NO 4W3050
RENAULT	8717	RENAULT	8718	RENAULT	8717
J		K		L	
	AYS CODE 801975		AYS CODE 801980		AYS CODE 801985
	PART NUMBER 79476		PART NUMBER 79477		PART NUMBER 72993
	OEM NO 5010260089		OEM NO 5010260090		OEM NO

	AYS CODE	CASTING	CONTROL UNIT	APPLICATION	SPLINE TEETH	NO of HOLE	H1	H2	H3	H4	H5	H6	H7	BUSHING (mm)	SPLINE TYPE	CONTROL ARM
A	801535	8009	527	RENAULT	27	1	175							14	BNA 227, Ø 35,0	double bent (short; R=65 mm)
B	801540	8008	529	RENAULT	27	1	175							14	BNA 227, Ø 35,0	bent
C	801545	8009	529	RENAULT	27	1	175							14	BNA 227, Ø 35,0	bent
D	801550	8008	529	RENAULT	27	1	175							14	BNA 227, Ø 35,0 BNA 227 D3,5	bent
E	801555	8009	529	RENAULT	27	1	175							14	BNA 227, Ø 35,0	bent
F	801955	8717	541	RENAULT	27	1	160							14	BNA 227, Ø 35,0	double bent (short; R=65 mm)
G	801960	8718	541	RENAULT	27	1	160							14	BNA 227, Ø 35,0	double bent (short; R=65 mm)
H	801965	8717	541	RENAULT	27	1	175							14	BNA 227, Ø 35,0	double bent (short; R=65 mm)
I	801970	8718	541	RENAULT	27	1	175							14	BNA 227, Ø 35,0	double bent (short; R=65 mm)
J	801975	8717	527	RENAULT	27	1	160							14	BNA 227, Ø 35,0	double bent (short; R=65 mm)
K	801980	8718	527	RENAULT	27	1	160							14	BNA 227, Ø 35,0	double bent (short; R=65 mm)
L	801985	8717	527	RENAULT	27	1	160							14	BNA 227, Ø 35,0	double bent (short; R=65 mm)











RENAULT	8718	RENAULT	8717	RENAULT	8718
A		B		C	
	AYS CODE 801990		AYS CODE 801995		AYS CODE 802000
	PART NUMBER 72994		PART NUMBER 79561		PART NUMBER 79560
	OEM NO		OEM NO		OEM NO
RENAULT	8717	RENAULT	8718	RENAULT	8718
D		E		F	
	AYS CODE 802005		AYS CODE 802010		AYS CODE 802015
	PART NUMBER 72786		PART NUMBER 72787		PART NUMBER 70899
	OEM NO		OEM NO		OEM NO 5000470912
RENAULT	8760	RENAULT	8761	RENAULT	8760
G		H		I	
	AYS CODE 802420		AYS CODE 802425		AYS CODE 802430
	PART NUMBER 79465		PART NUMBER 79466		PART NUMBER 72835
	OEM NO		OEM NO		OEM NO
RENAULT	8761	RENAULT	8760	RENAULT	8761
J		K		L	
	AYS CODE 802435		AYS CODE 802440		AYS CODE 802445
	PART NUMBER 72836		PART NUMBER 79000		PART NUMBER 79001
	OEM NO		OEM NO		OEM NO

	AYS CODE	CASTING	CONTROL UNIT	APPLICATION	SPLINE TEETH	NO of HOLE	H1	H2	H3	H4	H5	H6	H7	BUSHING (mm)	SPLINE TYPE	CONTROL ARM
A	801990	8718	527	RENAULT	27	1	160							14	BNA 227, Ø 35,0	double bent (short; R=65 mm)
B	801995	8717	527	RENAULT	27	1	175							14	BNA 227, Ø 35,0	double bent (short; R=65 mm)
C	802000	8718	527	RENAULT	27	1	175							14	BNA 227, Ø 35,0	double bent (short; R=65 mm)
D	802005	8717	527	RENAULT	27	1	175							14	BNA 227, Ø 35,0	double bent (short; R=65 mm)
E	802010	8718	527	RENAULT	27	1	175							14	BNA 227, Ø 35,0	double bent (short; R=65 mm)
F	802015	8718	527	RENAULT	27	1	246							16	BNA 227, Ø 35,0	double bent (short; R=65 mm)
G	802420	8760	527	RENAULT	27	1	160							14	BNA 227, Ø 35,0	double bent (short; R=65 mm)
H	802425	8761	527	RENAULT	27	1	160							14	BNA 227, Ø 35,0	double bent (short; R=65 mm)
I	802430	8760	527	RENAULT	27	1	160							14	BNA 227, Ø 35,0	double bent (short; R=65 mm)
J	802435	8761	527	RENAULT	27	1	160							14	BNA 227, Ø 35,0	double bent (short; R=65 mm)
K	802440	8760	527	RENAULT	27	1	175							14	BNA 227, Ø 35,0	double bent (short; R=65 mm)
L	802445	8761	527	RENAULT	27	1	175							14	BNA 227, Ø 35,0	double bent (short; R=65 mm)

RENAULT / SAF













RENAULT	8760	RENAULT	8761	RENAULT	475-20000
A		B		C	
	AYS CODE 802460		AYS CODE 802465		AYS CODE 803300
	PART NUMBER 72741		PART NUMBER 72740		PART NUMBER 72315
	OEM NO		OEM NO		OEM NO
RENAULT	475-20000	RENAULT	475-20000	RENAULT	475-20000
D		E		F	
	AYS CODE 803455		AYS CODE 803460		AYS CODE 803470
	PART NUMBER 72100		PART NUMBER 72099		PART NUMBER 72840
	OEM NO		OEM NO		OEM NO
RENAULT	475-20000	RENAULT	475-20000	RENAULT	475-20000
G		H		I	
	AYS CODE 803515		AYS CODE 803530		AYS CODE 803535
	PART NUMBER 72824		PART NUMBER 72601		PART NUMBER 72599
	OEM NO		OEM NO 5430016393		OEM NO 54300116310
RENAULT	475-20000	RENAULT	5027	SAF	5027
J		K		L	
	AYS CODE 803540		AYS CODE 803730		AYS CODE 800050
	PART NUMBER 72600		PART NUMBER 72642		PART NUMBER 80018
	OEM NO		OEM NO		OEM NO

	AYS CODE	CASTING	CONTROL UNIT	APPLICATION	SPLINE TEETH	NO of HOLE	H1	H2	H3	H4	H5	H6	H7	BUSHING (mm)	SPLINE TYPE	CONTROL ARM
A	802460	8760	527	RENAULT	28	1	160							14	SAE 1 1/2" 28 C	double bent (short; R=65 mm)
B	802465	8761	527	RENAULT	28	1	160							14	SAE 1 1/2" 28 C	double bent (short; R=65 mm)
C	803300	475-20000	527	RENAULT	19	1	160							14	A38x34 DIN 5482	double bent (short; R=65 mm)
D	803455	475-20000	527	RENAULT	27	1	140							14	BNA 227, Ø 35,0	double bent (short; R=65 mm)
E	803460	475-20000	527	RENAULT	27	1	150							14	BNA 227, Ø 35,0	double bent (short; R=65 mm)
F	803470	475-20000	527	RENAULT	27	1	190							14	BNA 227, Ø 35,0	double bent (short; R=65 mm)
G	803515	475-20000	527	RENAULT	28	1	160							14	SAE 1 1/2" 28 C	double bent (short; R=65 mm)
H	803530	475-20000	529	RENAULT	33	1	127							14	PITCH 24/48	bent
I	803535	475-20000	529	RENAULT	33	1	140							14	PITCH 24/48	bent
J	803540	475-20000	529	RENAULT	33	1	150							14	PITCH 24/48	bent
K	803730	5027	527	RENAULT	27	1	175							14	BNA 227, Ø 35,0	double bent (short; R=65 mm)
L	800050	5027	530	SAF	10	4	180	155	140	125				14	SAE 1 1/2" 10 C	ays-saddle type

SAF	5027	SAF	5027	SAF	475-20000
A		B		C	
	AYS CODE 800070		AYS CODE 800135		AYS CODE 800250
	PART NUMBER 80022		PART NUMBER 80041		PART NUMBER 80094
	OEM NO 4731840		OEM NO 4175026200		OEM NO
SAF	5039	SAF	5040	SAF	5041
D		E		F	
	AYS CODE 800435		AYS CODE 800440		AYS CODE 800800
	PART NUMBER 79338		PART NUMBER 79339		PART NUMBER 72827
	OEM NO		OEM NO		OEM NO 4175023000
SAF	5046	SAF	5047	SAF	8760
G		H		I	
	AYS CODE 801340		AYS CODE 801345		AYS CODE 802280
	PART NUMBER 72945		PART NUMBER 72946		PART NUMBER 79043
	OEM NO		OEM NO		OEM NO 4175023500
SAF	8761	SAF	8760	SAF	8761
J		K		L	
	AYS CODE 802285		AYS CODE 802300		AYS CODE 802305
	PART NUMBER 79337		PART NUMBER 70802		PART NUMBER 70803
	OEM NO		OEM NO MAS9250		OEM NO MAS9251

	AYS CODE	CASTING	CONTROL UNIT	APPLICATION	SPLINE TEETH	NO of HOLE	H1	H2	H3	H4	H5	H6	H7	BUSHING (mm)	SPLINE TYPE	CONTROL ARM
A	800070	5027	530	SAF	10	6	250	180	155	140	125	105		14	SAE 1 1/2" 10 C	ays-saddle type
B	800135	5027	530	SAF	10	4	180	155	140	125				14	SAE 1 1/2" 10 C	ays-saddle type
C	800250	475-20000	529	SAF	28	1	140							12,7	SAE 1 1/2" 28 C	bent
D	800435	5039	529	SAF	10	2	152	127						14	SAE 1 1/2" 10 C	bent
E	800440	5040	529	SAF	10	2	152	127						14	SAE 1 1/2" 10 C	bent
F	800800	5041	528	SAF	10	3	178	152	127					14 (L1: x)	SAE 1 1/2" 10 C	double bent (medium; R=78 mm)
G	801340	5046	529	SAF	10	3	198	173	148					14	SAE 1 1/2" 10 C	bent
H	801345	5047	529	SAF	10	3	198	173	148					14	SAE 1 1/2" 10 C	bent
I	802280	8760	527	SAF	10	2	179	152						14	SAE 1 1/2" 10 C	double bent (short; R=65 mm)
J	802285	8761	527	SAF	10	2	179	152						14	SAE 1 1/2" 10 C	double bent (short; R=65 mm)
K	802300	8760	529	SAF	10	3	203	179	151					14	SAE 1 1/2" 10 C	bent
L	802305	8761	529	SAF	10	3	203	179	151					14	SAE 1 1/2" 10 C	bent

SAF / KÄSSBOHRER

SAF	475-20000	SAF	475-20000	SAF	475-20000
A		B		C	
	AYS CODE 803155		AYS CODE 803185		AYS CODE 803190
	PART NUMBER 72334		PART NUMBER 72249		PART NUMBER 72554
	OEM NO		OEM NO 633107720		OEM NO 4175018100
SAF	475-20000	SAF	5027	SAF	5027
D		E		F	
	AYS CODE 803210		AYS CODE 803675		AYS CODE 803685
	PART NUMBER 72710		PART NUMBER 72645		PART NUMBER 79346
	OEM NO KB1035		OEM NO 0517482112		OEM NO
KÄSSBOHRER	5041	KÄSSBOHRER	8760	KÄSSBOHRER	8761
G		H		I	
	AYS CODE 800830		AYS CODE 802350		AYS CODE 802355
	PART NUMBER 72016		PART NUMBER 72591		PART NUMBER 72592
	OEM NO 82830003360		OEM NO 4W3575		OEM NO 4W2975
KÄSSBOHRER	8760	KÄSSBOHRER	8761	KÄSSBOHRER	8760
J		K		L	
	AYS CODE 802370		AYS CODE 802375		AYS CODE 802380
	PART NUMBER 72014		PART NUMBER 72015		PART NUMBER 70718
	OEM NO 4W3255		OEM NO 4W3260		OEM NO

	AYS CODE	CASTING	CONTROL UNIT	APPLICATION	SPLINE TEETH	NO of HOLE	H1	H2	H3	H4	H5	H6	H7	BUSHING (mm)	SPLINE TYPE	CONTROL ARM
A	803155	475-20000	529	SAF	10	3	200	155	130					14	SAE 1 1/2" 10 C	bent
B	803185	475-20000	529	SAF	10	4	203	178	152	127				14	SAE 1 1/2" 10 C	bent
C	803190	475-20000	529	SAF	10	1	203							14	SAE 1 1/2" 10 C	bent
D	803210	475-20000	527	SAF	10	4	210	180	150	125				14	SAE 1 1/2" 10 C	double bent (short; R=65 mm)
E	803675	5027	529	SAF	10	5	250	180	150	130	110			14 (L1: x)	SAE 1 1/2" 10 C	bent
F	803685	5027	530	SAF	10	6	250	180	155	140	125	105		14	SAE 1 1/2" 10 C	ays-saddle type
G	800830	5041	529	KÄSSBOHRER	19	1	145							14	A38x34 DIN 5482	bent
H	802350	8760	529	KÄSSBOHRER	19	1	150							14	A38x34 DIN 5482	bent
I	802355	8761	529	KÄSSBOHRER	19	1	150							14	A38x34 DIN 5482	bent
J	802370	8760	529	KÄSSBOHRER	19	1	160							14	A38x34 DIN 5482	bent
K	802375	8761	529	KÄSSBOHRER	19	1	160							14	A38x34 DIN 5482	bent
L	802380	8760	529	KÄSSBOHRER	19	1	170							14	A38x34 DIN 5482	bent

KÄSSBOHRER

A	KÄSSBOHRER	8761		AYS CODE 802385	PART NUMBER 70719	OEM NO
B	KÄSSBOHRER	8760		AYS CODE 802390	PART NUMBER 72370	OEM NO 82850000920
C	KÄSSBOHRER	8761		AYS CODE 802395	PART NUMBER 72371	OEM NO 82850000910
D	KÄSSBOHRER	8760		AYS CODE 802400	PART NUMBER 72368	OEM NO
E	KÄSSBOHRER	8761		AYS CODE 802405	PART NUMBER 72369	OEM NO
F	KÄSSBOHRER	8760		AYS CODE 802470	PART NUMBER 72372	OEM NO 82850000790
G	KÄSSBOHRER	8761		AYS CODE 802475	PART NUMBER 72373	OEM NO 82850000800
H	KÄSSBOHRER	8985		AYS CODE 802670	PART NUMBER 72017	OEM NO 82830005890
I	KÄSSBOHRER	8987		AYS CODE 802675	PART NUMBER 72018	OEM NO 82830005900
J	KÄSSBOHRER	475-20000		AYS CODE 803270	PART NUMBER 70720	OEM NO 4W2965
K	KÄSSBOHRER	475-20000		AYS CODE 803500	PART NUMBER 72376	OEM NO
L	KÄSSBOHRER	475-20000		AYS CODE 803545	PART NUMBER 70989	OEM NO 82830007570

	AYS CODE	CASTING	CONTROL UNIT	APPLICATION	SPLINE TEETH	NO of HOLE	H1	H2	H3	H4	H5	H6	H7	BUSHING (mm)	SPLINE TYPE	CONTROL ARM
A	802385	8761	529	KÄSSBOHRER	19	1	170							14	A38x34 DIN 5482	bent
B	802390	8760	540	KÄSSBOHRER	19	1	175							14	A38x34 DIN 5482	double bent (long; R=100 mm)
C	802395	8761	540	KÄSSBOHRER	19	1	175							14	A38x34 DIN 5482	double bent (long; R=100 mm)
D	802400	8760	529	KÄSSBOHRER	19	1	175							14	A38x34 DIN 5482	bent
E	802405	8761	529	KÄSSBOHRER	19	1	175							14	A38x34 DIN 5482	bent
F	802470	8760	529	KÄSSBOHRER	28	1	175							12,7	SAE 1 1/2" 28 C	bent
G	802475	8761	529	KÄSSBOHRER	28	1	175							12,7	SAE 1 1/2" 28 C	bent
H	802670	8985	529	KÄSSBOHRER	19	1	160							14	A38x34 DIN 5482	bent
I	802675	8987	529	KÄSSBOHRER	19	1	160							14	A38x34 DIN 5482	bent
J	803270	475-20000	529	KÄSSBOHRER	19	1	145							14	A38x34 DIN 5482	bent
K	803500	475-20000	529	KÄSSBOHRER	28	1	145							12,7	SAE 1 7/16" 28 C	bent
L	803545	475-20000	529	KÄSSBOHRER	37	2	180	150						14	A36x40 DIN 5481	bent



* CS > Customer Specific / Özel İmalat

(SELF-SETTING) FULL AUTOMATIC PRODUCT TYPES ARE CONTINUOUSLY INCREASED.
PLEASE CONTACT WITH OUR MARKETING DEPARTMENT FOR FURTHER INFORMATIONS.
TAM OTOMATİK ÜRÜNLERİMİZ SÜREKLİ OLARAK ARTMAKTADIR. DETAYLI BİLGİ İÇİN
PAZARLAMA DEPARTMANI İLE İLETİŞİME GEÇİNİZ.







ALL ORIGINAL NUMBERS, MARKS AND MODELS FROM VEHICLE MANUFACTURERS
LISTED IN THIS CATALOGUE ARE FOR COMPARISON PURPOSES ONLY AND MAY NOT BE
USED IN INVOICES TO VEHICLE OWNERS OR RESELLERS / ORJINAL ÜRÜN NUMARALARI
MÜŞTERİYİ BİLGİLENDİRME VE ÜRÜNE REFERANS AMAÇLI KULLANILMIŞTIR.

KÄSSBOHRER / VAN HOOL

A	KÄSSBOHRER	5027		AYS CODE 803775	PART NUMBER 72252	OEM NO
B	VAN HOOL	5037		AYS CODE 800615	PART NUMBER 79094	OEM NO E75701134
C	VAN HOOL	5038		AYS CODE 800620	PART NUMBER 79095	OEM NO E75701137
D	VAN HOOL	5039		AYS CODE 800685	PART NUMBER 79163	OEM NO 4W3410
E	VAN HOOL	5040		AYS CODE 800690	PART NUMBER 79162	OEM NO 4W3415
F	VAN HOOL	5039		AYS CODE 800705	PART NUMBER 79166	OEM NO
G	VAN HOOL	5040		AYS CODE 800710	PART NUMBER 79165	OEM NO
H	VAN HOOL	5046		AYS CODE 801360	PART NUMBER 72646	OEM NO 4W3225
I	VAN HOOL	5047		AYS CODE 801365	PART NUMBER 72647	OEM NO 4W3230
J	VAN HOOL	475-20000		AYS CODE 803000	PART NUMBER 70905	OEM NO 4W2460
K	VAN HOOL	475-20000		AYS CODE 803290	PART NUMBER 72330	OEM NO 4W2960
L	VAN HOOL	475-20000		AYS CODE 803465	PART NUMBER 10519	OEM NO

	AYS CODE	CASTING	CONTROL UNIT	APPLICATION	SPLINE TEETH	NO of HOLE	H1	H2	H3	H4	H5	H6	H7	BUSHING (mm)	SPLINE TYPE	CONTROL ARM
A	803775	5027	529	KÄSSBOHRER	37	6	250	180	165	150	135	120		14 (L1: x)	A36x40 DIN 5481	bent
B	800615	5037	527	VAN HOOL	19	1	152							14	A38x34 DIN 5482	double bent (short; R=65 mm)
C	800620	5038	527	VAN HOOL	19	1	152							14	A38x34 DIN 5482	double bent (short; R=65 mm)
D	800685	5039	527	VAN HOOL	10	1	152							14	SAE 1 1/2" 10 C	double bent (short; R=65 mm)
E	800690	5040	527	VAN HOOL	10	1	152							14	SAE 1 1/2" 10 C	double bent (short; R=65 mm)
F	800705	5039	527	VAN HOOL	19	1	152							14	A38x34 DIN 5482	double bent (short; R=65 mm)
G	800710	5040	527	VAN HOOL	19	1	152							14	A38x34 DIN 5482	double bent (short; R=65 mm)
H	801360	5046	527	VAN HOOL	19	1	150							14	A38x34 DIN 5482	double bent (short; R=65 mm)
I	801365	5047	527	VAN HOOL	19	1	150							14	A38x34 DIN 5482	double bent (short; R=65 mm)
J	803000	475-20000	527	VAN HOOL	10	1	152							14	SAE 1 1/2" 10 C	double bent (short; R=65 mm)
K	803290	475-20000	527	VAN HOOL	19	1	152							14	A38x34 DIN 5482	double bent (short; R=65 mm)
L	803465	475-20000	529	VAN HOOL	27	1	152							14	BNA 227	bent

VAN HOOL / AILSA / AJONA / ALBION / ALUIS / BABELSBERGER / BATTAGLINO

VAN HOOL	5027	VAN HOOL	5027	AILSA	5037
A		B		C	
	AYS CODE 803670		AYS CODE 803670		AYS CODE 800515
	PART NUMBER 79552		PART NUMBER 79552		PART NUMBER 70572
	OEM NO 105031111		OEM NO 105031111		OEM NO 6970/F
AILSA	5038	AILSA	8985	AILSA	8987
D		E		F	
	AYS CODE 800520		AYS CODE 802600		AYS CODE 802605
	PART NUMBER 70571		PART NUMBER 70832		PART NUMBER 70833
	OEM NO 6969/F		OEM NO KB2450		OEM NO KB2455
AJONA	475-20000	ALBION	475-20000	ALUIS	8760
G		H		I	
	AYS CODE 802970		AYS CODE 803485		AYS CODE 802290
	PART NUMBER 72570		PART NUMBER 79548		PART NUMBER 79599
	OEM NO		OEM NO		OEM NO
ALUIS	8761	BABELSBERGER	5027	BATTAGLINO	5046
J		K		L	
	AYS CODE 802295		AYS CODE 803580		AYS CODE 801310
	PART NUMBER 79600		PART NUMBER 72871		PART NUMBER 79030
	OEM NO		OEM NO 12234		OEM NO 4W1225

	AYS CODE	CASTING	CONTROL UNIT	APPLICATION	SPLINE TEETH	NO of HOLE	H1	H2	H3	H4	H5	H6	H7	BUSHING (mm)	SPLINE TYPE	CONTROL ARM
A	803670	5027	530	VAN HOOL	10	7	238	203	178	152	140	127	114	14	SAE 1 1/2" 10 C	ays-saddle type
B	803670	5027	530	VAN HOOL	10	7	238	203	178	152	140	127	114	14	SAE 1 1/2" 10 C	ays-saddle type
C	800515	5037	529	AILSA	10	1	140							12,7	SAE 1 1/2" 10 C	bent
D	800520	5038	529	AILSA	10	1	140							12,7	SAE 1 1/2" 10 C	bent
E	802600	8985	542	AILSA	10	1	147							12,7	SAE 1 1/2" 10 C	double bent (long; R=100 mm)
F	802605	8987	542	AILSA	10	1	147							12,7	SAE 1 1/2" 10 C	double bent (long; R=100 mm)
G	802970	475-20000	529	AJONA	10	1	150							14	SAE 1 1/2" 10 C	bent
H	803485	475-20000	527	ALBION	28	1	130							14	SAE 1 1/2" 28 C	double bent (short; R=65 mm)
I	802290	8760	528	ALUIS	10	1	200							12,7	SAE 1 1/2" 10 C	double bent (medium; R=78 mm)
J	802295	8761	528	ALUIS	10	1	200							12,7	SAE 1 1/2" 10 C	double bent (medium; R=78 mm)
K	803580	5027	529	BABELSBERGER	8	4	250	220	200	170				14	32 UNI 222	bent
L	801310	5046	529	BATTAGLINO	10	2	180	150						14	SAE 1 1/2" 10 C	bent















* CS > Customer Specific / Özel İmalat

(SELF-SETTING) FULL AUTOMATIC PRODUCT TYPES ARE CONTINUOUSLY INCREASED.
PLEASE CONTACT WITH OUR MARKETING DEPARTMENT FOR FURTHER INFORMATIONS.
TAM OTOMATİK ÜRÜNLERİMİZ SÜREKLİ OLARAK ARTMAKTADIR. DETAYLI BİLGİ İÇİN
PAZARLAMA DEPARTMANI İLE İLETİŞİME GEÇİNİZ.











ALL ORIGINAL NUMBERS, MARKS AND MODELS FROM VEHICLE MANUFACTURERS
LISTED IN THIS CATALOGUE ARE FOR COMPARISON PURPOSES ONLY AND MAY NOT BE
USED IN INVOICES TO VEHICLE OWNERS OR RESELLERS / ORJINAL ÜRÜN NUMARALARI
MÜŞTERİYİ BİLGİLENDİRME VE ÜRÜNE REFERANS AMAÇLI KULLANILMIŞTIR.

BATTAGLINO / BEDFORD / BOMBARDIER / BOVA / BPW

A	BATTAGLINO	5047		AYS CODE 801315	PART NUMBER 79031	OEM NO 4W1230
B	BEDFORD	475-20000		AYS CODE 802900	PART NUMBER 72149	OEM NO R8819/F
C	BOMBARDIER	5041		AYS CODE 800795	PART NUMBER 72030	OEM NO
D	BOVA	475-20000		AYS CODE 802925	PART NUMBER 11011	OEM NO
E	BPW	5027		AYS CODE 800055	PART NUMBER 80019	OEM NO 0557482873
F	BPW	5027		AYS CODE 800430	PART NUMBER c.s.	OEM NO
G	BPW	5041		AYS CODE 800815	PART NUMBER 70801	OEM NO
H	BPW	5046		AYS CODE 801310	PART NUMBER 79030	OEM NO 4W1225
I	BPW	5046		AYS CODE 801330	PART NUMBER 72884	OEM NO 0517456820
J	BPW	5047		AYS CODE 801335	PART NUMBER 72885	OEM NO 0517456810
K	BPW	5046		AYS CODE 801340	PART NUMBER 72945	OEM NO
L	BPW	5047		AYS CODE 801345	PART NUMBER 72946	OEM NO











	AYS CODE	CASTING	CONTROL UNIT	APPLICATION	SPLINE TEETH	NO of HOLE	H1	H2	H3	H4	H5	H6	H7	BUSHING (mm)	SPLINE TYPE	CONTROL ARM
A	801315	5047	529	BATTAGLINO	10	2	180	150						14	SAE 1 1/2" 10 C	bent
B	802900	475-20000	528	BEDFORD	10	1	140							12,7	SAE 1 1/2" 10 C	double bent (medium; R=78 mm)
C	800795	5041	529	BOMBARDIER	10	1	178							12,7	SAE 1 1/2" 10 C	bent
D	802925	475-20000	529	BOVA	10	1	140							14	SAE 1 1/2" 10 C	bent
E	800055	5027	530	BPW	10	6	250	180	165	150	135	120		14	SAE 1 1/2" 10 C	ays-saddle type
F	800430	5027	530	BPW	10	6	250	180	165	150	135	120		14	SAE 1 1/2" 10 C	ays-saddle type
G	800815	5041	542	BPW	10	1	180							16	SAE 1 1/2" 10 C	double bent (long; R=100 mm)
H	801310	5046	529	BPW	10	2	180	150						14	SAE 1 1/2" 10 C	bent
I	801330	5046	540	BPW	10	3	198	173	148					14	SAE 1 1/2" 10 C	double bent (long; R=100 mm)
J	801335	5047	540	BPW	10	3	198	173	148					14	SAE 1 1/2" 10 C	double bent (long; R=100 mm)
K	801340	5046	529	BPW	10	3	198	173	148					14	SAE 1 1/2" 10 C	bent
L	801345	5047	529	BPW	10	3	198	173	148					14	SAE 1 1/2" 10 C	bent

BPW / BREDAMENARINIBUS / BRITSAB

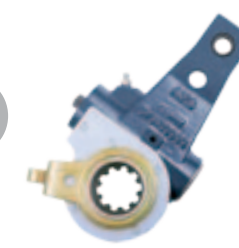

BPW	475-20000	BPW	475-20000	BPW	5027
A		B		C	
	AYS CODE 803105		AYS CODE 803200		AYS CODE 803675
	PART NUMBER 12307		PART NUMBER 72448		PART NUMBER 72645
	OEM NO		OEM NO		OEM NO 0517482112
BPW	5027	BPW	5027	BREDAMENARINIBUS	5041
D		E		F	
	AYS CODE 803695		AYS CODE 803815		AYS CODE 800760
	PART NUMBER c.s.		PART NUMBER c.s.		PART NUMBER 72182
	OEM NO		OEM NO		OEM NO S5005111
BREDAMENARINIBUS	475-20000	BREDAMENARINIBUS	475-20000	BREDAMENARINIBUS	475-20000
G		H		I	
	AYS CODE 802740		AYS CODE 802745		AYS CODE 803035
	PART NUMBER 72419		PART NUMBER 70919		PART NUMBER 70903
	OEM NO S5004035		OEM NO S5001048		OEM NO 4W3495
BREDAMENARINIBUS	475-20000	BRITSAB	8760	BRITSAB	8761
J		K		L	
	AYS CODE 803290		AYS CODE 802240		AYS CODE 802245
	PART NUMBER 72330		PART NUMBER 10714		PART NUMBER 10715
	OEM NO 4W2960		OEM NO F4003/F		OEM NO F4004/F

	AYS CODE	CASTING	CONTROL UNIT	APPLICATION	SPLINE TEETH	NO of HOLE	H1	H2	H3	H4	H5	H6	H7	BUSHING (mm)	SPLINE TYPE	CONTROL ARM
A	803105	475-20000	529	BPW	10	3	180	150	120					14	SAE 1 1/2" 10 C	bent
B	803200	475-20000	529	BPW	10	4	210	180	150	120				14	SAE 1 1/2" 10 C	bent
C	803675	5027	529	BPW	10	5	250	180	150	130	110			14 (L1: x)	SAE 1 1/2" 10 C	bent
D	803695	5027	530	BPW	10	6	250	180	165	150	135	120		14	SAE 1 1/2" 10 C	ays-saddle type
E	803815	5027	530	BPW	10	7	250	215	180	165	150	135	120	14 (L2, L3:x:11)	SAE 1 1/2" 10 C	ays-saddle type
F	800760	5041	527	BREDAMENARINIBUS	10	1	140							14	SAE 1 1/2" 10 C	double bent (short; R=65 mm)
G	802740	475-20000	541	BREDAMENARINIBUS	8	1	180							12,7	32 UNI 222	double bent (short; R=65 mm)
H	802745	475-20000	527	BREDAMENARINIBUS	8	1	180							12,7	32 UNI 222	double bent (short; R=65 mm)
I	803035	475-20000	527	BREDAMENARINIBUS	10	1	160							12,7	SAE 1 1/2" 10 C	double bent (short; R=65 mm)
J	803290	475-20000	527	BREDAMENARINIBUS	19	1	152							14	A38x34 DIN 5482	double bent (short; R=65 mm)
K	802240	8760	528	BRITSAB	10	1	168							12,7	SAE 1 1/2" 10 C	double bent (medium; R=78 mm)
L	802245	8761	528	BRITSAB	10	1	168							12,7	SAE 1 1/2" 10 C	double bent (medium; R=78 mm)

CARDI / CBM / COBRA / COMAUTO / DAB / DAEWOO



A	CARDI	475-20000		AYS CODE 802735	PART NUMBER 79363	OEM NO
B	CARDI	5027		AYS CODE 803575	PART NUMBER 79111	OEM NO 44015800
C	CBM	5044		AYS CODE 801180	PART NUMBER 70928	OEM NO 6034008
D	CBM	5044		AYS CODE 801185	PART NUMBER 70926	OEM NO 6034010
E	CBM	5045		AYS CODE 801190	PART NUMBER 70927	OEM NO 6034011
F	COBRA	475-20000		AYS CODE 800405	PART NUMBER c.s.	OEM NO
G	COBRA	475-20000		AYS CODE 803800	PART NUMBER c.s.	OEM NO
H	COMAUTO	475-20000		AYS CODE 803180	PART NUMBER 79444	OEM NO
I	DAB	8985		AYS CODE 802680	PART NUMBER 72761	OEM NO
J	DAB	8987		AYS CODE 802685	PART NUMBER 72762	OEM NO
K	DAEWOO	475-20000		AYS CODE 800150	PART NUMBER 80061	OEM NO
L	DAEWOO	5044		AYS CODE 801100	PART NUMBER 72856	OEM NO

	AYS CODE	CASTING	CONTROL UNIT	APPLICATION	SPLINE TEETH	NO of HOLE	H1	H2	H3	H4	H5	H6	H7	BUSHING (mm)	SPLINE TYPE	CONTROL ARM
A	802735	475-20000	530	CARDI	8	3	180	155	130					14	32 UNI 222	ays-saddle type
B	803575	5027	530	CARDI	8	6	250	180	165	150	135	120		14	32 UNI 222	ays-saddle type
C	801180	5044	528	CBM	27	1	180							14	BNA 227	double bent (medium; R=78 mm)
D	801185	5044	528	CBM	27	1	200							16	BNA 227	double bent (medium; R=78 mm)
E	801190	5045	528	CBM	27	1	200							14	BNA 227	double bent (medium; R=78 mm)
F	800405	475-20000	530	COBRA	10	2	152	115						14 (L1:x:14,5)	SAE 1 1/2" 10 C	saddle type
G	803800	475-20000	530	COBRA	20	2	152	115						14 (L1:x:14,5)	A40x36 DIN 5482	ays-saddle type
H	803180	475-20000	541	COMAUTO	10	1	203							14	SAE 1 1/2" 10 C	double bent (short; R=65 mm)
I	802680	8985	527	DAB	19	1	140							14	A38x34 DIN 5482	double bent (short; R=65 mm)
J	802685	8987	527	DAB	19	1	140							14	A38x34 DIN 5482	double bent (short; R=65 mm)
K	800150	475-20000	529	DAEWOO	25	1	150							16	JIS B 1602	bent
L	801100	5044	527	DAEWOO	25	1	150							16	JIS B 1602	double bent (short; R=65 mm)

DAEWOO	5045	DANA	8760	DANA	8761
A		B		C	
	AYS CODE 801105		AYS CODE 802060		AYS CODE 802065
	PART NUMBER 72857		PART NUMBER 70893		PART NUMBER 70894
	OEM NO		OEM NO X1811183		OEM NO X1811184
DANA	475-20000	DANA	475-20000	DANA	475-20000
D		E		F	
	AYS CODE 802750		AYS CODE 802755		AYS CODE 802765
	PART NUMBER 72575		PART NUMBER 72189		PART NUMBER 72190
	OEM NO		OEM NO E1013280		OEM NO E1013274
DANA	475-20000	DENNIS	5046	DENNIS	5047
G		H		I	
	AYS CODE 803045		AYS CODE 801200		AYS CODE 801205
	PART NUMBER 72144		PART NUMBER 79170		PART NUMBER 79171
	OEM NO		OEM NO R9990/F		OEM NO R9991/F
DENNIS	8760	DENNIS	8761	DENNIS	8760
J		K		L	
	AYS CODE 802040		AYS CODE 802045		AYS CODE 802180
	PART NUMBER 10937		PART NUMBER 10938		PART NUMBER 10274
	OEM NO R9025/F		OEM NO R9024/F		OEM NO













	AYS CODE	CASTING	CONTROL UNIT	APPLICATION	SPLINE TEETH	NO of HOLE	H1	H2	H3	H4	H5	H6	H7	BUSHING (mm)	SPLINE TYPE	CONTROL ARM
A	801105	5045	527	DAEWOO	25	1	150							16	JIS B 1602	double bent (short; R=65 mm)
B	802060	8760	529	DANA	10	1	140							12,7	SAE 1 1/2" 10 C	bent
C	802065	8761	529	DANA	10	1	140							12,7	SAE 1 1/2" 10 C	bent
D	802750	475-20000	529	DANA	10	1	102							12,7	SAE 1 1/2" 10 C	bent
E	802755	475-20000	529	DANA	10	1	108							12,7	SAE 1 1/2" 10 C	bent
F	802765	475-20000	529	DANA	10	1	114							12,7	SAE 1 1/2" 10 C	bent
G	803045	475-20000	528	DANA	10	1	165							12,7	SAE 1 1/2" 10 C	double bent (medium; R=78 mm)
H	801200	5046	528	DENNIS	10	1	140							12,7	SAE 1 1/2" 10 C	double bent (medium; R=78 mm)
I	801205	5047	528	DENNIS	10	1	140							12,7	SAE 1 1/2" 10 C	double bent (medium; R=78 mm)
J	802040	8760	528	DENNIS	10	1	140							12,7	SAE 1 1/2" 10 C	double bent (medium; R=78 mm)
K	802045	8761	528	DENNIS	10	1	140							12,7	SAE 1 1/2" 10 C	double bent (medium; R=78 mm)
L	802180	8760	528	DENNIS	10	1	165							12,7	SAE 1 1/2" 10 C	double bent (medium; R=78 mm)

DENNIS / DONG A / DONGFENG

DENNIS	8761	DENNIS	475-20000	DENNIS	475-20000
A		B		C	
	AYS CODE 802185		AYS CODE 802790		AYS CODE 802830
	PART NUMBER 10275		PART NUMBER 10939		PART NUMBER 72364
	OEM NO		OEM NO 651630		OEM NO KB2375
DENNIS	475-20000	DENNIS	475-20000	DENNIS	475-20000
D		E		F	
	AYS CODE 802840		AYS CODE 802900		AYS CODE 802905
	PART NUMBER 70740		PART NUMBER 72149		PART NUMBER 70573
	OEM NO		OEM NO R8819/F		OEM NO
DENNIS	475-20000	DENNIS	475-20000	DONG A	475-20000
G		H		I	
	AYS CODE 802910		AYS CODE 802915		AYS CODE 803135
	PART NUMBER 79062		PART NUMBER 70946		PART NUMBER 79685
	OEM NO R9567/F		OEM NO 1587482		OEM NO
DONGFENG	475-20000	DONGFENG	475-20000	DONGFENG	475-20000
J		K		L	
	AYS CODE 802805		AYS CODE 802820		AYS CODE 802835
	PART NUMBER 79617		PART NUMBER 79618		PART NUMBER 79646
	OEM NO		OEM NO		OEM NO

	AYS CODE	CASTING	CONTROL UNIT	APPLICATION	SPLINE TEETH	NO of HOLE	H1	H2	H3	H4	H5	H6	H7	BUSHING (mm)	SPLINE TYPE	CONTROL ARM
A	802185	8761	528	DENNIS	10	1	165							12,7	SAE 1 1/2" 10 C	double bent (medium; R=78 mm)
B	802790	475-20000	529	DENNIS	10	1	115							12,7	SAE 1 1/2" 10 C	bent
C	802830	475-20000	528	DENNIS	10	1	127							12,7	SAE 1 1/2" 10 C	double bent (medium; R=78 mm)
D	802840	475-20000	529	DENNIS	10	1	127							12,7	SAE 1 1/2" 10 C	bent
E	802900	475-20000	528	DENNIS	10	1	140							12,7	SAE 1 1/2" 10 C	double bent (medium; R=78 mm)
F	802905	475-20000	529	DENNIS	10	1	140							12,7	SAE 1 1/2" 10 C	bent
G	802910	475-20000	529	DENNIS	10	2	140	115						12,7	SAE 1 1/2" 10 C	bent
H	802915	475-20000	529	DENNIS	10	1	140							12,7	SAE 1 1/2" 10 C	bent
I	803135	475-20000	530	DONG A	10	3	190	165	140					12,7	SAE 1 1/2" 10 C	ays-saddle type
J	802805	475-20000	529	DONGFENG	10	1	125							12	SAE 1 1/2" 10 C	bent
K	802820	475-20000	529	DONGFENG	10	1	125							12	SAE 1 1/2" 10 C	bent
L	802835	475-20000	527	DONGFENG	10	1	110							12	SAE 1 1/2" 10 C	double bent (short; R=65 mm)

DONGFENG / EATON / ENASA / ERF / FIAT / FODEN

EATON	475-20000	ENASA	475-20000	ERF	475-20000
A		B		C	
	AYS CODE 802840		AYS CODE 803320		AYS CODE 802765
	PART NUMBER 70740		PART NUMBER 72831		PART NUMBER 72190
	OEM NO		OEM NO		OEM NO E1013274
FIAT	475-20000	FIAT	475-20000	FIAT	5027
D		E		F	
	AYS CODE 802725		AYS CODE 802730		AYS CODE 803570
	PART NUMBER 70809		PART NUMBER 70891		PART NUMBER 70892
	OEM NO 4W3160		OEM NO 4W3060		OEM NO 4W3380
FODEN	5041	FODEN	5041	FODEN	5041
G		H		I	
	AYS CODE 800725		AYS CODE 800885		AYS CODE 800890
	PART NUMBER 72179		PART NUMBER 12132		PART NUMBER 79184
	OEM NO 4W3775		OEM NO XH12132C		OEM NO XH79184/C
FODEN	5041	FODEN	5041	FODEN	5041
J		K		L	
	AYS CODE 800895		AYS CODE 800905		AYS CODE 800910
	PART NUMBER 72181		PART NUMBER 79461		PART NUMBER 79682
	OEM NO XH72181/C		OEM NO AT79461		OEM NO

	AYS CODE	CASTING	CONTROL UNIT	APPLICATION	SPLINE TEETH	NO of HOLE	H1	H2	H3	H4	H5	H6	H7	BUSHING (mm)	SPLINE TYPE	CONTROL ARM
A	802840	475-20000	529	EATON	10	1	127							12,7	SAE 1 1/2" 10 C	bent
B	803320	475-20000	527	ENASA	19	1	180							14	A38x34 DIN 5482	double bent (short; R=65 mm)
C	802765	475-20000	529	ERF	10	1	114							12,7	SAE 1 1/2" 10 C	bent
D	802725	475-20000	527	FIAT	8	1	160							12,7	32 UNI 222	double bent (short; R=65 mm)
E	802730	475-20000	527	FIAT	8	1	170							12,7	32 UNI 222	double bent (short; R=65 mm)
F	803570	5027	541	FIAT	8	1	180							12,7	32 UNI 222	double bent (short; R=65 mm)
G	800725	5041	542	FODEN	10	1	127							12,7	SAE 1 1/2" 10 C	double bent (long; R=100 mm)
H	800885	5041	540	FODEN	28	1	127							12,7	SAE 1 1/2" 28 C	double bent (long; R=100 mm)
I	800890	5041	528	FODEN	28	1	127							12,7	SAE 1 1/2" 28 C	double bent (medium; R=78 mm)
J	800895	5041	540	FODEN	28	1	140							12,7	SAE 1 1/2" 28 C	double bent (long; R=100 mm)
K	800905	5041	528	FODEN	28	1	140							12,7	SAE 1 1/2" 28 C	double bent (medium; R=78 mm)
L	800910	5041	540	FODEN	28	1	143							14	SAE 1 1/2" 28 C	double bent (long; R=100 mm)



* CS > Customer Specific / Özel İmalat

(SELF-SETTING) FULL AUTOMATIC PRODUCT TYPES ARE CONTINUOUSLY INCREASED.
PLEASE CONTACT WITH OUR MARKETING DEPARTMENT FOR FURTHER INFORMATIONS.
TAM OTOMATİK ÜRÜNLERİMİZ SÜREKLİ OLARAK ARTMAKTADIR. DETAYLI BİLGİ İÇİN
PAZARLAMA DEPARTMANI İLE İLETİŞİME GEÇİNİZ.

ALL ORIGINAL NUMBERS, MARKS AND MODELS FROM VEHICLE MANUFACTURERS
LISTED IN THIS CATALOGUE ARE FOR COMPARISON PURPOSES ONLY AND MAY NOT BE
USED IN INVOICES TO VEHICLE OWNERS OR RESELLERS / ORJINAL ÜRÜN NUMARALARI
MÜŞTERİYİ BİLGİLENDİRME VE ÜRÜNE REFERANS AMAÇLI KULLANILMIŞTIR.

FODEN

FODEN	5046	FODEN	5047	FODEN	8185
A		B		C	
	AYS CODE 801250		AYS CODE 801255		AYS CODE 801825
	PART NUMBER 79601		PART NUMBER 79602		PART NUMBER 12170
	OEM NO		OEM NO		OEM NO
FODEN	8186	FODEN	8704	FODEN	8705
D		E		F	
	AYS CODE 801830		AYS CODE 801885		AYS CODE 801890
	PART NUMBER 12171		PART NUMBER 79349		PART NUMBER 79350
	OEM NO		OEM NO		OEM NO
FODEN	8760	FODEN	8761	FODEN	475-20000
G		H		I	
	AYS CODE 802180		AYS CODE 802185		AYS CODE 802720
	PART NUMBER 10274		PART NUMBER 10275		PART NUMBER 12182
	OEM NO		OEM NO		OEM NO
FODEN	475-20000	FODEN	5027	FODEN	5027
J		K		L	
	AYS CODE 803045		AYS CODE 803735		AYS CODE 803740
	PART NUMBER 72144		PART NUMBER 72939		PART NUMBER 79133
	OEM NO		OEM NO XH72939/C		OEM NO XH79133/C

	AYS CODE	CASTING	CONTROL UNIT	APPLICATION	SPLINE TEETH	NO of HOLE	H1	H2	H3	H4	H5	H6	H7	BUSHING (mm)	SPLINE TYPE	CONTROL ARM
A	801250	5046	541	FODEN	10	1	165							14	SAE 1 1/2" 10 C	double bent (short; R=65 mm)
B	801255	5047	541	FODEN	10	1	165							14	SAE 1 1/2" 10 C	double bent (short; R=65 mm)
C	801825	8185	527	FODEN	26	1	145							14	N42x1,5x9H DIN 5480	double bent (short; R=65 mm)
D	801830	8186	527	FODEN	26	1	145							14	N42x1,5x9H DIN 5480	double bent (short; R=65 mm)
E	801885	8704	541	FODEN	10	1	165							14	SAE 1 1/2" 10 C	double bent (short; R=65 mm)
F	801890	8705	541	FODEN	10	1	165							14	SAE 1 1/2" 10 C	double bent (short; R=65 mm)
G	802180	8760	528	FODEN	10	1	165							12,7	SAE 1 1/2" 10 C	double bent (medium; R=78 mm)
H	802185	8761	528	FODEN	10	1	165							12,7	SAE 1 1/2" 10 C	double bent (medium; R=78 mm)
I	802720	475-20000	541	FODEN	8	1	160							12,7	32 UNI 222	double bent (short; R=65 mm)
J	803045	475-20000	528	FODEN	10	1	165							12,7	SAE 1 1/2" 10 C	double bent (medium; R=78 mm)
K	803735	5027	529	FODEN	28	1	127							12,7	SAE 1 1/2" 28 C	bent
L	803740	5027	529	FODEN	28	1	140							12,7	SAE 1 1/2" 28 C	bent

FRUEHAUF	5027	FRUEHAUF	5027	FRUEHAUF	8760
A		B		C	
	AYS CODE 800065		AYS CODE 800410		AYS CODE 802100
	PART NUMBER 80021		PART NUMBER c.s.		PART NUMBER 12141
	OEM NO KB1020D		OEM NO		OEM NO ASY55481
FRUEHAUF	8761	FRUEHAUF	475-20000	FRUEHAUF	475-20000
D		E		F	
	AYS CODE 802105		AYS CODE 803145		AYS CODE 803150
	PART NUMBER 12142		PART NUMBER 72115		PART NUMBER 72103
	OEM NO ASY55482		OEM NO		OEM NO CF351148
FRUEHAUF	475-20000	FRUEHAUF	475-20000	FRUEHAUF	475-20000
G		H		I	
	AYS CODE 803165		AYS CODE 803550		AYS CODE 803555
	PART NUMBER 70576		PART NUMBER 70979		PART NUMBER 70854
	OEM NO FL932/002		OEM NO		OEM NO
FRUEHAUF	475-20000	FRUEHAUF	5027	FRUEHAUF	5027
J		K		L	
	AYS CODE 803560		AYS CODE 803590		AYS CODE 803655
	PART NUMBER 70959		PART NUMBER 72569		PART NUMBER 72256
	OEM NO		OEM NO CF351972		OEM NO KB1065

	AYS CODE	CASTING	CONTROL UNIT	APPLICATION	SPLINE TEETH	NO of HOLE	H1	H2	H3	H4	H5	H6	H7	BUSHING (mm)	SPLINE TYPE	CONTROL ARM
A	800065	5027	530	FRUEHAUF	37	4	215	153	129	105				14 (L1: 16)	SAE J 498	ays-saddle type
B	800410	5027	530	FRUEHAUF	37	6	250	180	155	140	125	105		14	ANSI B92 1A-1976, 24/48	ays-saddle type
C	802100	8760	529	FRUEHAUF	10	1	140							14	SAE 1 1/2" 10 C	bent
D	802105	8761	529	FRUEHAUF	10	1	140							14	SAE 1 1/2" 10 C	bent
E	803145	475-20000	529	FRUEHAUF	10	3	200	142	118					12,7	SAE 1 1/2" 10 C	bent
F	803150	475-20000	529	FRUEHAUF	10	3	200	142	118					14	SAE 1 1/2" 10 C	bent
G	803165	475-20000	529	FRUEHAUF	10	4	203	178	152	127				12,7	SAE 1 1/2" 10 C	bent
H	803550	475-20000	529	FRUEHAUF	37	4	203	178	152	127				12,7 (L1: X)	SAE J 498	bent
I	803555	475-20000	527	FRUEHAUF	37	4	210	180	150	125				14 (L1: x)	SAE J 498	double bent (short; R=65 mm)
J	803560	475-20000	527	FRUEHAUF	37	4	210	180	155	130				14 (L1: x)	SAE J 498	double bent (short; R=65 mm)
K	803590	5027	529	FRUEHAUF	10	1	118							14	SAE 1 1/2" 10 C	bent
L	803655	5027	529	FRUEHAUF	10	5	215	181	153	129	105			12,7	SAE 1 1/2" 10 C	bent

FRUEHAUF / GKN / GO-AXLES / GORICA / HENRED-FRUEHAUF / HINO

A FRUEHAUF 	5027 AYS CODE 803760 PART NUMBER 72104 OEM NO 4W1165	B FRUEHAUF 	5027 AYS CODE 803805 PART NUMBER c.s. OEM NO	C GKN 	8760 AYS CODE 802160 PART NUMBER 79158 OEM NO F4706/F
D GKN 	8761 AYS CODE 802165 PART NUMBER 79159 OEM NO F4707/F	E GKN 	475-20000 AYS CODE 803025 PART NUMBER 79735 OEM NO	F GO-AXLES 	5027 AYS CODE 800100 PART NUMBER 80032 OEM NO
G GO-AXLES 	5027 AYS CODE 800120 PART NUMBER 80037 OEM NO	H GORICA 	5027 AYS CODE 803585 PART NUMBER 72733 OEM NO	I HENRED-FRUEHAUF 	5027 AYS CODE 800100 PART NUMBER 80032 OEM NO
J HENRED-FRUEHAUF 	5027 AYS CODE 800120 PART NUMBER 80037 OEM NO	K HINO 	5044 AYS CODE 801005 PART NUMBER 79674 OEM NO	L HINO 	5045 AYS CODE 801010 PART NUMBER 79675 OEM NO

	AYS CODE	CASTING	CONTROL UNIT	APPLICATION	SPLINE TEETH	NO of HOLE	H1	H2	H3	H4	H5	H6	H7	BUSHING (mm)	SPLINE TYPE	CONTROL ARM
A	803760	5027	529	FRUEHAUF	37	4	210	153	129	105				14	SAE J 498	bent
B	803805	5027	530	FRUEHAUF	37	2	152	127						14	SAE J 498	ays-saddle type
C	802160	8760	528	GKN	10	1	152							12,7	SAE 1 1/2" 10 C	double bent (medium; R=78 mm)
D	802165	8761	528	GKN	10	1	152							12,7	SAE 1 1/2" 10 C	double bent (medium; R=78 mm)
E	803025	475-20000	529	GKN	10	2	155	127						12,7	SAE 1 1/2" 10 C	bent
F	800100	5027	530	GO-AXLES	10	2	150	125						12,7	SAE 1 1/2" 10 C	ays-saddle type
G	800120	5027	530	GO-AXLES	37	2	150	125						12,7	SAE J 498	ays-saddle type
H	803585	5027	530	GORICA	8	6	250	180	155	140	125	105		14	32 UNI 222	ays-saddle type
I	800100	5027	530	HENRED-FRUEHAUF	10	2	150	125						12,7	SAE 1 1/2" 10 C	ays-saddle type
J	800120	5027	530	HENRED-FRUEHAUF	37	2	150	125						12,7	SAE J 498	ays-saddle type
K	801005	5044	529	HINO	12	1	150							12,7	JIS D 2001 (35x12)	bent
L	801010	5045	529	HINO	12	1	150							12,7	JIS D 2001 (35x12)	bent

HINO	8760	HINO	8761	HINO	475-20000
A		B		C	
	AYS CODE 802340		AYS CODE 802345		AYS CODE 803280
	PART NUMBER 12254		PART NUMBER 12255		PART NUMBER 72697
	OEM NO 4W2405		OEM NO 4W2410		OEM NO
HYUNDAI	5044	HYUNDAI	5045	HYUNDAI	5041
D		E		F	
	AYS CODE 800395		AYS CODE 800400		AYS CODE 800415
	PART NUMBER 80191		PART NUMBER 80192		PART NUMBER c.s.
	OEM NO		OEM NO		OEM NO
HYUNDAI	5044	HYUNDAI	5045	HYUNDAI	5041
G		H		I	
	AYS CODE 800420		AYS CODE 800425		AYS CODE 800730
	PART NUMBER c.s.		PART NUMBER c.s.		PART NUMBER 72777
	OEM NO		OEM NO		OEM NO
HYUNDAI	5041	IKARUS	8717	IKARUS	8718
J		K		L	
	AYS CODE 800770		AYS CODE 801925		AYS CODE 801930
	PART NUMBER 72778		PART NUMBER 12363		PART NUMBER 12364
	OEM NO		OEM NO		OEM NO





	AYS CODE	CASTING	CONTROL UNIT	APPLICATION	SPLINE TEETH	NO of HOLE	H1	H2	H3	H4	H5	H6	H7	BUSHING (mm)	SPLINE TYPE	CONTROL ARM
A	802340	8760	529	HINO	19	1	150							12,7	A38x34 DIN 5482	bent
B	802345	8761	529	HINO	19	1	150							12,7	A38x34 DIN 5482	bent
C	803280	475-20000	529	HINO	19	1	150							12,7	A38x34 DIN 5482	bent
D	800395	5044	529	HYUNDAI	25	1	170							14	JIS B 1602	bent
E	800400	5045	529	HYUNDAI	25	1	170							14	JIS B 1602	bent
F	800415	5041	532	HYUNDAI	25	1	145							16	JIS B 1602	double bent (short; R=65 mm)
G	800420	5044	532	HYUNDAI	25	1	145							14	JIS B 1602	double bent (short; R=65 mm)
H	800425	5045	532	HYUNDAI	25	1	145							14	JIS B 1602	double bent (short; R=65 mm)
I	800730	5041	527	HYUNDAI	10	1	135							16	SAE 1 1/2" 10 C	double bent (short; R=65 mm)
J	800770	5041	527	HYUNDAI	10	1	145							16	SAE 1 1/2" 10 C	double bent (short; R=65 mm)
K	801925	8717	527	IKARUS	19	1	165							14	A38x34 DIN 5482	double bent (short; R=65 mm)
L	801930	8718	527	IKARUS	19	1	165							14	A38x34 DIN 5482	double bent (short; R=65 mm)

ISUZU / IVECO / IVECO PEGASO

ISUZU	475-20000	IVECO	475-20000	IVECO PEGASO	5046
A		B		C	
	AYS CODE 803360		AYS CODE 803290		AYS CODE 801390
	PART NUMBER C.S.		PART NUMBER 72330		PART NUMBER 72216
	OEM NO		OEM NO 4W2960		OEM NO 914244
IVECO PEGASO	5047	IVECO PEGASO	5046	IVECO PEGASO	5047
D		E		F	
	AYS CODE 801395		AYS CODE 801400		AYS CODE 801405
	PART NUMBER 72215		PART NUMBER 72444		PART NUMBER 72445
	OEM NO 914245		OEM NO		OEM NO
IVECO PEGASO	5046	IVECO PEGASO	5047	IVECO PEGASO	475-20000
G		H		I	
	AYS CODE 801420		AYS CODE 801425		AYS CODE 803295
	PART NUMBER 72446		PART NUMBER 72447		PART NUMBER 72750
	OEM NO 4W3355		OEM NO 4W3360		OEM NO
IVECO PEGASO	475-20000	IVECO PEGASO	475-20000	IVECO PEGASO	475-20000
J		K		L	
	AYS CODE 803300		AYS CODE 803310		AYS CODE 803320
	PART NUMBER 72315		PART NUMBER 72709		PART NUMBER 72831
	OEM NO		OEM NO		OEM NO

	AYS CODE	CASTING	CONTROL UNIT	APPLICATION	SPLINE TEETH	NO of HOLE	H1	H2	H3	H4	H5	H6	H7	BUSHING (mm)	SPLINE TYPE	CONTROL ARM
A	803360	475-20000	532	ISUZU	24	1	130							12,7	SAE 1 1/4" 24 C	double bent (short; R=65 mm)
B	803290	475-20000	527	IVECO	19	1	152							14	A38x34 DIN 5482	double bent (short; R=65 mm)
C	801390	5046	529	IVECO PEGASO	19	1	160							14	A38x34 DIN 5482	bent
D	801395	5047	529	IVECO PEGASO	19	1	160							14	A38x34 DIN 5482	bent
E	801400	5046	541	IVECO PEGASO	19	1	160							14	A38x34 DIN 5482	double bent (short; R=65 mm)
F	801405	5047	541	IVECO PEGASO	19	1	160							14	A38x34 DIN 5482	double bent (short; R=65 mm)
G	801420	5046	541	IVECO PEGASO	19	1	180							14	A38x34 DIN 5482	double bent (short; R=65 mm)
H	801425	5047	541	IVECO PEGASO	19	1	180							14	A38x34 DIN 5482	double bent (short; R=65 mm)
I	803295	475-20000	541	IVECO PEGASO	19	1	160							14	A38x34 DIN 5482	double bent (short; R=65 mm)
J	803300	475-20000	527	IVECO PEGASO	19	1	160							14	A38x34 DIN 5482	double bent (short; R=65 mm)
K	803310	475-20000	541	IVECO PEGASO	19	1	180							14	A38x34 DIN 5482	double bent (short; R=65 mm)
L	803320	475-20000	527	IVECO PEGASO	19	1	180							14	A38x34 DIN 5482	double bent (short; R=65 mm)

JELE CZ / JELTZ / JIMECAL / JINAN CHINA / JP SPAIN / JPB



JELE CZ	475-20000	JELTZ	5037	JELTZ	5038
A		B		C	
	AYS CODE 803255		AYS CODE 800635		AYS CODE 800640
	PART NUMBER 70726		PART NUMBER 12313		PART NUMBER 12314
	OEM NO 1021029692945		OEM NO 1021029692517		OEM NO 1021029692518
JELTZ	5041	JELTZ	5027	JIMECAL	475-20000
D		E		F	
	AYS CODE 800880		AYS CODE 803705		AYS CODE 802975
	PART NUMBER 12310		PART NUMBER 12356		PART NUMBER 72817
	OEM NO		OEM NO		OEM NO 4W3530
JINAN CHINA	5041	JP SPAIN	5046	JP SPAIN	5047
G		H		I	
	AYS CODE 800745		AYS CODE 801240		AYS CODE 801245
	PART NUMBER 79657		PART NUMBER 79455		PART NUMBER 79456
	OEM NO		OEM NO 4W3565		OEM NO 4W3570
JP SPAIN	475-20000	JPB	5041	JPB	5044
J		K		L	
	AYS CODE 803365		AYS CODE 800855		AYS CODE 801070
	PART NUMBER 79454		PART NUMBER 79661		PART NUMBER 79659
	OEM NO 4W3560		OEM NO		OEM NO

	AYS CODE	CASTING	CONTROL UNIT	APPLICATION	SPLINE TEETH	NO of HOLE	H1	H2	H3	H4	H5	H6	H7	BUSHING (mm)	SPLINE TYPE	CONTROL ARM
A	803255	475-20000	529	JELE CZ	19	1	122							14	A38x34 DIN 5482	bent
B	800635	5037	529	JELTZ	27	1	180							14	BNA 227, Ø 35,0	bent
C	800640	5038	529	JELTZ	27	1	180							14	BNA 227, Ø 35,0	bent
D	800880	5041	527	JELTZ	27	1	180							14	BNA 227	double bent (short; R=65 mm)
E	803705	5027	529	JELTZ	19	1	130							14	A38x34 DIN 5482	bent
F	802975	475-20000	527	JIMECAL	10	2	150	125						14	SAE 1 1/2" 10 C	double bent (short; R=65 mm)
G	800745	5041	531	JINAN CHINA	10	1	140							12,7	SAE 1 1/2" 10 C	bent-Ø 8
H	801240	5046	527	JP SPAIN	10	1	160							14	SAE 1 1/2" 10 C	double bent (short; R=65 mm)
I	801245	5047	527	JP SPAIN	10	1	160							14	SAE 1 1/2" 10 C	double bent (short; R=65 mm)
J	803365	475-20000	527	JP SPAIN	24	1	160							14	SAE 1 1/4" 24 C	double bent (short; R=65 mm)
K	800855	5041	528	JPB	25	2	165	135						14	JIS B 1602 L=29,4	double bent (medium; R=78 mm)
L	801070	5044	528	JPB	25	1	145							14	JIS B 1602 L=29,4	double bent (medium; R=78 mm)

JPB / KÄLBLE / KAMAZ / KYNOS

JPB A 	5045 AYS CODE 801075 PART NUMBER 79660 OEM NO	JPB B 	475-20000 AYS CODE 803030 PART NUMBER 79658 OEM NO	KÄLBLE C 	8717 AYS CODE 802020 PART NUMBER 72206 OEM NO
KÄLBLE D 	8718 AYS CODE 802025 PART NUMBER 72207 OEM NO	KÄLBLE E 	475-20000 AYS CODE 803435 PART NUMBER 72205 OEM NO	KAMAZ F 	5016 AYS CODE 800125 PART NUMBER 80039 OEM NO
KAMAZ G 	5015 AYS CODE 800130 PART NUMBER 80040 OEM NO	KAMAZ H 	8202 AYS CODE 801835 PART NUMBER 79128 OEM NO	KAMAZ I 	8760 AYS CODE 802170 PART NUMBER 79258 OEM NO
KAMAZ J 	8761 AYS CODE 802175 PART NUMBER 79259 OEM NO	KYNOS K 	8008 AYS CODE 801480 PART NUMBER 79650 OEM NO	KYNOS L 	8009 AYS CODE 801485 PART NUMBER 79651 OEM NO

	AYS CODE	CASTING	CONTROL UNIT	APPLICATION	SPLINE TEETH	NO of HOLE	H1	H2	H3	H4	H5	H6	H7	BUSHING (mm)	SPLINE TYPE	CONTROL ARM
A	801075	5045	528	JPB	25	1	145							14	JIS B 1602 L=29,4	double bent (medium; R=78 mm)
B	803030	475-20000	528	JPB	10	2	155	127						12,7	SAE 1 1/2" 10 C	double bent (medium; R=78 mm)
C	802020	8717	528	KÄLBLE	37	1	176							16	A36x40 DIN 5481	double bent (medium; R=78 mm)
D	802025	8718	528	KÄLBLE	37	1	176							16	A36x40 DIN 5481	double bent (medium; R=78 mm)
E	803435	475-20000	529	KÄLBLE	26	1	152							16	N42x1,5x9H DIN 5480	bent
F	800125	5016	527	KAMAZ	10	1	145							14	SAE 1 1/2" 10 C	double bent (short; R=65 mm)
G	800130	5015	527	KAMAZ	10	1	145							14	SAE 1 1/2" 10 C	double bent (short; R=65 mm)
H	801835	8202	542	KAMAZ	10	1	130							12	SAE 1 1/2" 10 C	double bent (long; R=100 mm)
I	802170	8760	527	KAMAZ	10	1	165							14	SAE 1 1/2" 10 C	double bent (short; R=65 mm)
J	802175	8761	527	KAMAZ	10	1	165							14	SAE 1 1/2" 10 C	double bent (short; R=65 mm)
K	801480	8008	527	KYNOS	10	1	165							14	SAE 1 1/2" 10 C	double bent (short; R=65 mm)
L	801485	8009	527	KYNOS	10	1	165							14	SAE 1 1/2" 10 C	double bent (short; R=65 mm)

LEYLAND	5037	LEYLAND	5038	LEYLAND	5037
A		B		C	
	AYS CODE 800555		AYS CODE 800560		AYS CODE 800565
	PART NUMBER 70527		PART NUMBER 70526		PART NUMBER 70583
	OEM NO		OEM NO 843684		OEM NO KB2335
LEYLAND	5038	LEYLAND	5037	LEYLAND	5038
D		E		F	
	AYS CODE 800570		AYS CODE 800575		AYS CODE 800580
	PART NUMBER 70582		PART NUMBER 70652		PART NUMBER 70651
	OEM NO KB2390		OEM NO		OEM NO
LEYLAND	5037	LEYLAND	5038	LEYLAND	5041
G		H		I	
	AYS CODE 800585		AYS CODE 800590		AYS CODE 800720
	PART NUMBER 72105		PART NUMBER 72106		PART NUMBER 72019
	OEM NO KB2495		OEM NO KB2500		OEM NO 0067148S1
LEYLAND	8760	LEYLAND	8761	LEYLAND	8760
J		K		L	
	AYS CODE 802120		AYS CODE 802125		AYS CODE 802210
	PART NUMBER 70987		PART NUMBER 70988		PART NUMBER 70840
	OEM NO		OEM NO		OEM NO AAU3348













	AYS CODE	CASTING	CONTROL UNIT	APPLICATION	SPLINE TEETH	NO of HOLE	H1	H2	H3	H4	H5	H6	H7	BUSHING (mm)	SPLINE TYPE	CONTROL ARM
A	800555	5037	543	LEYLAND	10	1	165							12,7	SAE 1 1/2" 10 C	double bent (short; R=65 mm)
B	800560	5038	543	LEYLAND	10	1	165							12,7	SAE 1 1/2" 10 C	double bent (short; R=65 mm)
C	800565	5037	529	LEYLAND	10	1	165							12,7	SAE 1 1/2" 10 C	bent
D	800570	5038	529	LEYLAND	10	1	165							12,7	SAE 1 1/2" 10 C	bent
E	800575	5037	527	LEYLAND	10	2	178	140						12,7	SAE 1 1/2" 10 C	double bent (short; R=65 mm)
F	800580	5038	527	LEYLAND	10	2	178	140						12,7	SAE 1 1/2" 10 C	double bent (short; R=65 mm)
G	800585	5037	529	LEYLAND	10	1	178							12,7	SAE 1 1/2" 10 C	bent
H	800590	5038	529	LEYLAND	10	1	178							12,7	SAE 1 1/2" 10 C	bent
I	800720	5041	540	LEYLAND	10	1	127							12,7	SAE 1 1/2" 10 C	double bent (long; R=100 mm)
J	802120	8760	529	LEYLAND	10	1	152							12,7	SAE 1 1/2" 10 C	bent
K	802125	8761	529	LEYLAND	10	1	152							12,7	SAE 1 1/2" 10 C	bent
L	802210	8760	529	LEYLAND	10	1	165							12,7	SAE 1 1/2" 10 C	bent

LEYLAND

LEYLAND	8761	LEYLAND	8760	LEYLAND	8761
A		B		C	
	AYS CODE 802215		AYS CODE 802250		AYS CODE 802255
	PART NUMBER 70841		PART NUMBER 70511		PART NUMBER 70512
	OEM NO AAU3347		OEM NO KB2655		OEM NO ES10907246
LEYLAND	475-20000	LEYLAND	475-20000	LEYLAND	475-20000
D		E		F	
	AYS CODE 802770		AYS CODE 802775		AYS CODE 802780
	PART NUMBER 70510		PART NUMBER 72406		PART NUMBER 72195
	OEM NO KB2650		OEM NO KB2180		OEM NO
LEYLAND	475-20000	LEYLAND	475-20000	LEYLAND	475-20000
G		H		I	
	AYS CODE 802890		AYS CODE 802895		AYS CODE 802985
	PART NUMBER 70851		PART NUMBER 72407		PART NUMBER 72588
	OEM NO 1465300151		OEM NO KB2670		OEM NO NRK3550
LEYLAND	475-20000	LEYLAND	475-20000	LEYLAND	475-20000
J		K		L	
	AYS CODE 803040		AYS CODE 803055		AYS CODE 803090
	PART NUMBER 70660		PART NUMBER 70650		PART NUMBER 70530
	OEM NO		OEM NO		OEM NO KB2835



	AYS CODE	CASTING	CONTROL UNIT	APPLICATION	SPLINE TEETH	NO of HOLE	H1	H2	H3	H4	H5	H6	H7	BUSHING (mm)	SPLINE TYPE	CONTROL ARM
A	802215	8761	529	LEYLAND	10	1	165							12,7	SAE 1 1/2" 10 C	bent
B	802250	8760	529	LEYLAND	10	1	178							12,7	SAE 1 1/2" 10 C	bent
C	802255	8761	529	LEYLAND	10	1	178							12,7	SAE 1 1/2" 10 C	bent
D	802770	475-20000	529	LEYLAND	10	1	114							12,7	SAE 1 1/2" 10 C	bent
E	802775	475-20000	527	LEYLAND	10	1	133							12,7	SAE 1 1/2" 10 C	double bent (short; R=65 mm)
F	802780	475-20000	527	LEYLAND	10	1	115							12,7	SAE 1 1/2" 10 C	double bent (short; R=65 mm)
G	802890	475-20000	527	LEYLAND	10	1	140							12,7	SAE 1 1/2" 10 C	double bent (short; R=65 mm)
H	802895	475-20000	527	LEYLAND	10	1	140							12,7	SAE 1 1/2" 10 C	double bent (short; R=65 mm)
I	802985	475-20000	540	LEYLAND	10	1	152							12,7	SAE 1 1/2" 10 C	double bent (long; R=100 mm)
J	803040	475-20000	529	LEYLAND	10	1	160							12,7	SAE 1 1/2" 10 C	bent
K	803055	475-20000	529	LEYLAND	10	1	165							12,7	SAE 1 1/2" 10 C	bent
L	803090	475-20000	543	LEYLAND	10	1	178							12,7	SAE 1 1/2" 10 C	double bent (short; R=65 mm)

LEYLAND / LIAZ / MAG / MARSHALL

LEYLAND	475-20000	LEYLAND	475-20000	LEYLAND	475-20000
A		B		C	
AYS CODE 803095	AYS CODE 803100	AYS CODE 803175	AYS CODE 803195	AYS CODE 801150	AYS CODE 801155
PART NUMBER 70634	PART NUMBER 70945	PART NUMBER 70532	PART NUMBER 70787	PART NUMBER 72867	PART NUMBER 72868
OEM NO KB2370	OEM NO KB2315	OEM NO KB2430	OEM NO CAL1984	OEM NO	OEM NO
LEYLAND	475-20000	LIAZ	5044	LIAZ	5045
D		E		F	
AYS CODE 803195	AYS CODE 801170	AYS CODE 801175	AYS CODE 801170	AYS CODE 801175	AYS CODE 801925
PART NUMBER 70787	PART NUMBER 72566	PART NUMBER 72567	PART NUMBER 72566	PART NUMBER 72567	PART NUMBER 12363
OEM NO CAL1984	OEM NO	OEM NO	OEM NO	OEM NO	OEM NO
LIAZ	5044	LIAZ	5045	LIAZ	8717
G		H		I	
AYS CODE 801170	AYS CODE 801930	AYS CODE 803565	AYS CODE 801170	AYS CODE 801925	AYS CODE 801925
PART NUMBER 72566	PART NUMBER 12364	PART NUMBER 72154	PART NUMBER 72566	PART NUMBER 12363	PART NUMBER 12363
OEM NO	OEM NO	OEM NO	OEM NO	OEM NO	OEM NO
LIAZ	8718	MAG	475-20000	MARSHALL	475-20000
J		K		L	
AYS CODE 801930	AYS CODE 803565	AYS CODE 803565	AYS CODE 803565	AYS CODE 803505	AYS CODE 803505
PART NUMBER 12364	PART NUMBER 72154	PART NUMBER 72154	PART NUMBER 72154	PART NUMBER 79092	PART NUMBER 79092
OEM NO	OEM NO	OEM NO	OEM NO	OEM NO A4037441	OEM NO A4037441











	AYS CODE	CASTING	CONTROL UNIT	APPLICATION	SPLINE TEETH	NO of HOLE	H1	H2	H3	H4	H5	H6	H7	BUSHING (mm)	SPLINE TYPE	CONTROL ARM
A	803095	475-20000	529	LEYLAND	10	1	179							12,7	SAE 1 1/2" 10 C	bent
B	803100	475-20000	529	LEYLAND	10	1	180							12,7	SAE 1 1/2" 10 C	bent
C	803175	475-20000	529	LEYLAND	10	1	203							12,7	SAE 1 1/2" 10 C	bent
D	803195	475-20000	529	LEYLAND	10	2	203	151						12,7 (L1: x)	SAE 1 1/2" 10 C	bent
E	801150	5044	541	LIAZ	26	1	160							14	40x1,5 CSN 014950,1	double bent (short; R=65 mm)
F	801155	5045	541	LIAZ	26	1	160							14	40x1,5 CSN 014950,1	double bent (short; R=65 mm)
G	801170	5044	527	LIAZ	26	1	200							14	40x1,5 CSN 014950,1	double bent (short; R=65 mm)
H	801175	5045	527	LIAZ	26	1	200							14	40x1,5 CSN 014950,1	double bent (short; R=65 mm)
I	801925	8717	527	LIAZ	19	1	165							14	A38x34 DIN 5482	double bent (short; R=65 mm)
J	801930	8718	527	LIAZ	19	1	165							14	A38x34 DIN 5482	double bent (short; R=65 mm)
K	803565	475-20000	529	MAG	-	4	203	178	152	127				12,7	SQUARE 26,9	bent
L	803505	475-20000	540	MARSHALL	28	1	152							12,7	SAE 1 7/16" 28 C	double bent (long; R=100 mm)

MARSHALL / MCW

MARSHALL	475-20000	MCW	5037	MCW	5038
A		B		C	
	AYS CODE 803520		AYS CODE 800525		AYS CODE 800530
	PART NUMBER 79082		PART NUMBER 72450		PART NUMBER 72451
	OEM NO A4037350		OEM NO		OEM NO
MCW	8185	MCW	8186	MCW	8760
D		E		F	
	AYS CODE 801765		AYS CODE 801770		AYS CODE 802060
	PART NUMBER 70930		PART NUMBER 70931		PART NUMBER 70893
	OEM NO X2210967		OEM NO X2210966		OEM NO X1811183
MCW	8761	MCW	8760	MCW	8761
G		H		I	
	AYS CODE 802065		AYS CODE 802210		AYS CODE 802215
	PART NUMBER 70894		PART NUMBER 70840		PART NUMBER 70841
	OEM NO X1811184		OEM NO AAU3348		OEM NO AAU3347
MCW	475-20000	MCW	475-20000	MCW	475-20000
J		K		L	
	AYS CODE 802755		AYS CODE 802765		AYS CODE 802785
	PART NUMBER 72189		PART NUMBER 72190		PART NUMBER 72361
	OEM NO E1013280		OEM NO E1013274		OEM NO X2052967

	AYS CODE	CASTING	CONTROL UNIT	APPLICATION	SPLINE TEETH	NO of HOLE	H1	H2	H3	H4	H5	H6	H7	BUSHING (mm)	SPLINE TYPE	CONTROL ARM
A	803520	475-20000	540	MARSHALL	28	1	165							12,7	SAE 1 7/16" 28 C	double bent (long; R=100 mm)
B	800525	5037	528	MCW	10	1	140							12,7	SAE 1 1/2" 10 C	double bent (medium; R=78 mm)
C	800530	5038	528	MCW	10	1	140							12,7	SAE 1 1/2" 10 C	double bent (medium; R=78 mm)
D	801765	8185	529	MCW	10	1	140							12,7	SAE 1 1/2" 10 C	bent
E	801770	8186	529	MCW	10	1	140							12,7	SAE 1 1/2" 10 C	bent
F	802060	8760	529	MCW	10	1	140							12,7	SAE 1 1/2" 10 C	bent
G	802065	8761	529	MCW	10	1	140							12,7	SAE 1 1/2" 10 C	bent
H	802210	8760	529	MCW	10	1	165							12,7	SAE 1 1/2" 10 C	bent
I	802215	8761	529	MCW	10	1	165							12,7	SAE 1 1/2" 10 C	bent
J	802755	475-20000	529	MCW	10	1	108							12,7	SAE 1 1/2" 10 C	bent
K	802765	475-20000	529	MCW	10	1	114							12,7	SAE 1 1/2" 10 C	bent
L	802785	475-20000	529	MCW	10	1	115							12,7	SAE 1 1/2" 10 C	bent

MCW / MEIHOKU / MENARINI / MILITARY TRAILER / MOTORAL / MÜLLER / NEOCAR

A	MCW	475-20000		AYS CODE 802905	PART NUMBER 70573	OEM NO
B	MCW	475-20000		AYS CODE 803045	PART NUMBER 72144	OEM NO
C	MEIHOKU	8760		AYS CODE 802330	PART NUMBER 79493	OEM NO 4W4000
D	MEIHOKU	8761		AYS CODE 802335	PART NUMBER 79494	OEM NO 4W4005
E	MENARINI	475-20000		AYS CODE 803035	PART NUMBER 70903	OEM NO 4W3495
F	MILITARY TRAILER	475-20000		AYS CODE 803120	PART NUMBER 72143	OEM NO CF3510393
G	MOTORAL	5046		AYS CODE 801410	PART NUMBER 79491	OEM NO
H	MOTORAL	5047		AYS CODE 801415	PART NUMBER 79492	OEM NO
I	MÜLLER	5027		AYS CODE 803605	PART NUMBER 79091	OEM NO
J	MÜLLER	5027		AYS CODE 803610	PART NUMBER 79114	OEM NO
K	NEOCAR	5046		AYS CODE 801450	PART NUMBER 79520	OEM NO 442795200000
L	NEOCAR	5047		AYS CODE 801455	PART NUMBER 79521	OEM NO 442795210000

	AYS CODE	CASTING	CONTROL UNIT	APPLICATION	SPLINE TEETH	NO of HOLE	H1	H2	H3	H4	H5	H6	H7	BUSHING (mm)	SPLINE TYPE	CONTROL ARM
A	802905	475-20000	529	MCW	10	1	140							12,7	SAE 1 1/2" 10 C	bent
B	803045	475-20000	528	MCW	10	1	165							12,7	SAE 1 1/2" 10 C	double bent (medium; R=78 mm)
C	802330	8760	528	MEIHOKU	14	1	150							12,7	JIS D 2001 40x12x2,5	double bent (medium; R=78 mm)
D	802335	8761	528	MEIHOKU	14	1	150							12,7	JIS D 2001 40x12x2,5	double bent (medium; R=78 mm)
E	803035	475-20000	527	MENARINI	10	1	160							12,7	SAE 1 1/2" 10 C	double bent (short; R=65 mm)
F	803120	475-20000	529	MILITARY TRAILER	10	1	190							12,7	SAE 1 1/2" 10 C	bent
G	801410	5046	542	MOTORAL	19	1	170							14	A38x34 DIN 5482	double bent (long; R=100 mm)
H	801415	5047	542	MOTORAL	19	1	170							14	A38x34 DIN 5482	double bent (long; R=100 mm)
I	803605	5027	530	MÜLLER	10	5	200	145	126	115	101			14	SAE 1 1/2" 10 C	ays-saddle type
J	803610	5027	540	MÜLLER	10	5	200	145	126	115	101			14	SAE 1 1/2" 10 C	double bent (long; R=100 mm)
K	801450	5046	530	NEOCAR	26	1	150							14	40x1,5 CSN 014950,1	ays-saddle type
L	801455	5047	530	NEOCAR	26	1	150							14	40x1,5 CSN 014950,1	ays-saddle type













* CS > Customer Specific / Özel İmalat

(SELF-SETTING) FULL AUTOMATIC PRODUCT TYPES ARE CONTINUOUSLY INCREASED.
PLEASE CONTACT WITH OUR MARKETING DEPARTMENT FOR FURTHER INFORMATIONS.
TAM OTOMATİK ÜRÜNLERİMİZ SÜREKLİ OLARAK ARTMAKTADIR. DETAYLI BİLGİ İÇİN
PAZARLAMA DEPARTMANI İLE İLETİŞİME GEÇİNİZ.

ALL ORIGINAL NUMBERS, MARKS AND MODELS FROM VEHICLE MANUFACTURERS
LISTED IN THIS CATALOGUE ARE FOR COMPARISON PURPOSES ONLY AND MAY NOT BE
USED IN INVOICES TO VEHICLE OWNERS OR RESELLERS. / ORJINAL ÜRÜN NUMARALARI
MÜŞTERİYİ BİLGİLENDİRME VE ÜRÜNE REFERANS AMAÇLI KULLANILMIŞTIR.

NEOPLAN / NISSAN / NISSAN / NORTH BENZ / OPTARE / PEGASO

NEOPLAN	8037	NEOPLAN	8162	NEOPLAN	8202
A		B		C	
	AYS CODE 801560		AYS CODE 801720		AYS CODE 801840
	PART NUMBER 70706		PART NUMBER 70753		PART NUMBER 72177
	OEM NO KB2440		OEM NO KB2445		OEM NO 4W2845
NEOPLAN	8202	NISSAN	475-20000	NISSAN	475-20000
D		E		F	
	AYS CODE 801850		AYS CODE 803370		AYS CODE 803380
	PART NUMBER 70775		PART NUMBER 79103		PART NUMBER 79192
	OEM NO KB2100		OEM NO		OEM NO
NISSAN	475-20000	NORTH BENZ	5041	OPTARE	5041
G		H		I	
	AYS CODE 803410		AYS CODE 800845		AYS CODE 800900
	PART NUMBER 79652		PART NUMBER 79648		PART NUMBER 79177
	OEM NO		OEM NO		OEM NO L2220055
PEGASO	5046	PEGASO	5047	PEGASO	475-20000
J		K		L	
	AYS CODE 801350		AYS CODE 801355		AYS CODE 803305
	PART NUMBER 72618		PART NUMBER 72619		PART NUMBER 72214
	OEM NO 917983		OEM NO		OEM NO 718984

	AYS CODE	CASTING	CONTROL UNIT	APPLICATION	SPLINE TEETH	NO of HOLE	H1	H2	H3	H4	H5	H6	H7	BUSHING (mm)	SPLINE TYPE	CONTROL ARM
A	801560	8037	527	NEOPLAN	26	1	115							14	N42x1,5x9H DIN 5480	double bent (short; R=65 mm)
B	801720	8162	528	NEOPLAN	26	1	145							14	N42x1,5x9H DIN 5480	double bent (medium; R=78 mm)
C	801840	8202	527	NEOPLAN	19	1	130							14	A38x34 DIN 5482	double bent (short; R=65 mm)
D	801850	8202	527	NEOPLAN	26	1	130							14	N42x1,5x9H DIN 5480	double bent (short; R=65 mm)
E	803370	475-20000	527	NISSAN	25	1	125							12,7	JIS B 1602	double bent (short; R=65 mm)
F	803380	475-20000	527	NISSAN	25	1	152							12,7	JIS B 1602	double bent (short; R=65 mm)
G	803410	475-20000	528	NISSAN	25	2	195	165						14 (L1: x)	JIS B 1602 L=29,4	double bent (medium; R=78 mm)
H	800845	5041	529	NORTH BENZ	24	1	140							12,7	N38x1,5x9H DIN 5480	bent
I	800900	5041	529	OPTARE	28	1	140							12,7	SAE 1 1/2" 28 C	bent
J	801350	5046	527	PEGASO	19	1	140							14	A38x34 DIN 5482	double bent (short; R=65 mm)
K	801355	5047	527	PEGASO	19	1	140							14	A38x34 DIN 5482	double bent (short; R=65 mm)
L	803305	475-20000	529	PEGASO	19	1	160							14	A38x34 DIN 5482	bent

PEGASO / PERROD / PPS / RABA

PERROD	8202	PPS	5046	PPS	5047
A		B		C	
	AYS CODE 803795		AYS CODE 801430		AYS CODE 801435
	PART NUMBER 72157		PART NUMBER 79345		PART NUMBER 79344
	OEM NO		OEM NO		OEM NO
PPS	5046	PPS	5047	RABA	5041
D		E		F	
	AYS CODE 801460		AYS CODE 801465		AYS CODE 800840
	PART NUMBER 79126		PART NUMBER 79127		PART NUMBER 79079
	OEM NO 5801108031		OEM NO 5801108032		OEM NO 4W3905
RABA	8185	RABA	8186	RABA	475-20000
G		H		I	
	AYS CODE 801785		AYS CODE 801790		AYS CODE 803340
	PART NUMBER 79107		PART NUMBER 79108		PART NUMBER 79121
	OEM NO		OEM NO		OEM NO 654172
RABA	475-20000	RABA	475-20000	RABA	5027
J		K		L	
	AYS CODE 803345		AYS CODE 803350		AYS CODE 803710
	PART NUMBER 72928		PART NUMBER 79056		PART NUMBER 72614
	OEM NO 4W3950		OEM NO 4W3900		OEM NO

	AYS CODE	CASTING	CONTROL UNIT	APPLICATION	SPLINE TEETH	NO of HOLE	H1	H2	H3	H4	H5	H6	H7	BUSHING (mm)	SPLINE TYPE	CONTROL ARM
A	803795	8202	527	PERROD	19	1	130							14	A38x34 DIN 5482	double bent (short; R=65 mm)
B	801430	5046	530	PPS	26	1	140							14	40x1,5 CSN 014950,1	ays-saddle type
C	801435	5047	530	PPS	26	1	140							14	40x1,5 CSN 014950,1	ays-saddle type
D	801460	5046	530	PPS	26	1	170							14	40x1,5 CSN 014950,1	ays-saddle type
E	801465	5047	530	PPS	26	1	170							14	40x1,5 CSN 014950,1	ays-saddle type
F	800840	5041	529	RABA	20	1	175							14	A40x36 DIN 5482	bent
G	801785	8185	529	RABA	20	1	145							14	A40x36 DIN 5482	bent
H	801790	8186	529	RABA	20	1	145							14	A40x36 DIN 5482	bent
I	803340	475-20000	529	RABA	20	1	145							14	A40x36 DIN 5482	bent
J	803345	475-20000	529	RABA	20	2	155	127						14	A40x36 DIN 5482	bent
K	803350	475-20000	529	RABA	20	1	175							14	A40x36 DIN 5482	bent
L	803710	5027	527	RABA	20	5	250	225	200	175	150			14	A40x36 DIN 5482	double bent (short; R=65 mm)











* CS > Customer Specific / Özel İmalat

(SELF-SETTING) FULL AUTOMATIC PRODUCT TYPES ARE CONTINUOUSLY INCREASED.
PLEASE CONTACT WITH OUR MARKETING DEPARTMENT FOR FURTHER INFORMATIONS.
TAM OTOMATİK ÜRÜNLERİMİZ SÜREKLİ OLARAK ARTMAKTADIR. DETAYLI BİLGİ İÇİN
PAZARLAMA DEPARTMANI İLE İLETİŞİME GEÇİNİZ.













ALL ORIGINAL NUMBERS, MARKS AND MODELS FROM VEHICLE MANUFACTURERS
LISTED IN THIS CATALOGUE ARE FOR COMPARISON PURPOSES ONLY AND MAY NOT BE
USED IN INVOICES TO VEHICLE OWNERS OR RESELLERS / ORJINAL ÜRÜN NUMARALARI
MÜŞTERİYİ BİLGİLENDİRME VE ÜRÜNE REFERANS AMAÇLI KULLANILMIŞTIR.

RELIANCE MERCURY / REYNOLDS / ROR

A	RELIANCE MERCURY 	475-20000 AYS CODE 803525 PART NUMBER 79268 OEM NO 819137
B	REYNOLDS 	5027 AYS CODE 803615 PART NUMBER 79067 OEM NO 209923
C	ROR 	5027 AYS CODE 800060 PART NUMBER 80020 OEM NO TP02003059X
D	ROR 	475-20000 AYS CODE 800325 PART NUMBER 80150 OEM NO
E	ROR 	5037 AYS CODE 800595 PART NUMBER 79097 OEM NO TP02003003X
F	ROR 	5038 AYS CODE 800610 PART NUMBER 79098 OEM NO TP02003004X
G	ROR 	5041 AYS CODE 800915 PART NUMBER 79080 OEM NO 77909
H	ROR 	8760 AYS CODE 802100 PART NUMBER 12141 OEM NO ASY55481
I	ROR 	8761 AYS CODE 802105 PART NUMBER 12142 OEM NO ASY55482
J	ROR 	475-20000 AYS CODE 803125 PART NUMBER 70886 OEM NO
K	ROR 	475-20000 AYS CODE 803165 PART NUMBER 70576 OEM NO FL932/002
L	ROR 	475-20000 AYS CODE 803170 PART NUMBER 70887 OEM NO













	AYS CODE	CASTING	CONTROL UNIT	APPLICATION	SPLINE TEETH	NO of HOLE	H1	H2	H3	H4	H5	H6	H7	BUSHING (mm)	SPLINE TYPE	CONTROL ARM
A	803525	475-20000	529	RELIANCE MERCURY	28	1	165							12,7	SAE 1 1/2" 28 C	bent
B	803615	5027	528	REYNOLDS	10	2	203	127						14	SAE 1 1/2" 10 C	double bent (medium; R=78 mm)
C	800060	5027	530	ROR	10	5	205	153	140	127	115			14	SAE 1 1/2" 10 C	ays-saddle type
D	800325	475-20000	529	ROR	28	1	140							14	SAE 1 1/2" 28 C	bent
E	800595	5037	541	ROR	10	3	180	150	125					14	SAE 1 1/2" 10 C	double bent (short; R=65 mm)
F	800610	5038	541	ROR	10	3	180	150	125					14	SAE 1 1/2" 10 C	double bent (short; R=65 mm)
G	800915	5041	542	ROR	28	1	165							14	SAE 1 7/16" 28 C	double bent (long; R=100 mm)
H	802100	8760	529	ROR	10	1	140							14	SAE 1 1/2" 10 C	bent
I	802105	8761	529	ROR	10	1	140							14	SAE 1 1/2" 10 C	bent
J	803125	475-20000	529	ROR	10	2	190	140						12,7	SAE 1 1/2" 10 C	bent
K	803165	475-20000	529	ROR	10	4	203	178	152	127				12,7	SAE 1 1/2" 10 C	bent
L	803170	475-20000	529	ROR	10	4	203	178	152	127				12,7	SAE 1 1/2" 10 C	bent

ROR / RUTHMANN / SAB / SAE

ROR	5027	ROR	5027	ROR	5027
A		B		C	
	AYS CODE 803635		AYS CODE 803640		AYS CODE 803650
	PART NUMBER 72359		PART NUMBER 79051		PART NUMBER 72260
	OEM NO CF351531		OEM NO P17179051		OEM NO 72095
ROR	5027	ROR	5027	ROR	5027
D		E		F	
	AYS CODE 803655		AYS CODE 803660		AYS CODE 803670
	PART NUMBER 72256		PART NUMBER 72255		PART NUMBER 79552
	OEM NO KB1065		OEM NO CF3505492		OEM NO 105031111
ROR	5027	RUTHMANN	5041	SAB	475-20000
G		H		I	
	AYS CODE 803765		AYS CODE 800805		AYS CODE 803125
	PART NUMBER 72259		PART NUMBER 72862		PART NUMBER 70886
	OEM NO		OEM NO		OEM NO
SAB	475-20000	SAE	5027	SAE	5047
J		K		L	
	AYS CODE 803170		AYS CODE 800270		AYS CODE 800280
	PART NUMBER 70887		PART NUMBER 80108		PART NUMBER 80124
	OEM NO		OEM NO		OEM NO

	AYS CODE	CASTING	CONTROL UNIT	APPLICATION	SPLINE TEETH	NO of HOLE	H1	H2	H3	H4	H5	H6	H7	BUSHING (mm)	SPLINE TYPE	CONTROL ARM
A	803635	5027	529	ROR	10	3	215	142	118					14 (L1: 16)	SAE 1 1/2" 10 C	bent
B	803640	5027	541	ROR	10	5	215	181	153	129	105			14	SAE 1 1/2" 10 C	double bent (short; R=65 mm)
C	803650	5027	529	ROR	10	5	215	181	153	129	105			14	SAE 1 1/2" 10 C	bent
D	803655	5027	529	ROR	10	5	215	181	153	129	105			12,7	SAE 1 1/2" 10 C	bent
E	803660	5027	529	ROR	10	5	215	181	153	129	105			12,7	SAE 1 1/2" 10 C	bent
F	803670	5027	530	ROR	10	7	238	203	178	152	140	127	114	14	SAE 1 1/2" 10 C	ays-saddle type
G	803765	5027	529	ROR	37	5	215	181	153	129	105			14 (L1: x)	SAE J 498	bent
H	800805	5041	540	RUTHMANN	10	3	178	152	127					14	SAE 1 1/2" 10 C	double bent (long; R=100 mm)
I	803125	475-20000	529	SAB	10	2	190	140						12,7	SAE 1 1/2" 10 C	bent
J	803170	475-20000	529	SAB	10	4	203	178	152	127				12,7	SAE 1 1/2" 10 C	bent
K	800270	5027	530	SAE	10	7	250	180	165	150	135	120	105	14	SAE 1 1/2" 10 C	ays-saddle type
L	800280	5047	527	SAE	10	2	180	150						14	SAE 1 1/2" 10 C	double bent (short; R=65 mm)

SAE

SAE A 	5046 AYS CODE 800285 PART NUMBER 80125 OEM NO	SAE B 	5027 AYS CODE 800290 PART NUMBER 80126 OEM NO 09319299	SAE C 	5047 AYS CODE 800295 PART NUMBER 80129 OEM NO
SAE D 	5046 AYS CODE 800300 PART NUMBER 80130 OEM NO	SAE E 	5041 AYS CODE 800810 PART NUMBER 72837 OEM NO 09012061	SAE F 	5044 AYS CODE 800955 PART NUMBER 79138 OEM NO 09002209
SAE G 	5045 AYS CODE 800960 PART NUMBER 79139 OEM NO 09002210	SAE H 	5044 AYS CODE 800965 PART NUMBER 72751 OEM NO 9002153	SAE I 	5045 AYS CODE 800970 PART NUMBER 72752 OEM NO 9002154
SAE J 	5044 AYS CODE 800975 PART NUMBER 72869 OEM NO 9002201	SAE K 	5045 AYS CODE 800980 PART NUMBER 72870 OEM NO 9002202	SAE L 	5046 AYS CODE 801300 PART NUMBER 79144 OEM NO 9002224

	AYS CODE	CASTING	CONTROL UNIT	APPLICATION	SPLINE TEETH	NO of HOLE	H1	H2	H3	H4	H5	H6	H7	BUSHING (mm)	SPLINE TYPE	CONTROL ARM
A	800285	5046	527	SAE	10	2	180	150						14	SAE 1 1/2" 10 C	double bent (short; R=65 mm)
B	800290	5027	530	SAE	10	6	180	165	150	135	120	105		14	SAE 1 1/2" 10 C	ays-saddle type
C	800295	5047	527	SAE	10	1	165							14	SAE 1 1/2" 10 C	double bent (short; R=65 mm)
D	800300	5046	527	SAE	10	1	165							14	SAE 1 1/2" 10 C	double bent (short; R=65 mm)
E	800810	5041	527	SAE	10	2	178	153						14	SAE 1 1/2" 10 C	double bent (short; R=65 mm)
F	800955	5044	541	SAE	10	2	178	153						14	SAE 1 1/2" 10 C	double bent (short; R=65 mm)
G	800960	5045	541	SAE	10	2	178	153						14	SAE 1 1/2" 10 C	double bent (short; R=65 mm)
H	800965	5044	529	SAE	10	2	180	150						14	SAE 1 1/2" 10 C	bent
I	800970	5045	529	SAE	10	2	180	150						14	SAE 1 1/2" 10 C	bent
J	800975	5044	527	SAE	10	2	180	150						14	SAE 1 1/2" 10 C	double bent (short; R=65 mm)
K	800980	5045	527	SAE	10	2	180	150						14	SAE 1 1/2" 10 C	double bent (short; R=65 mm)
L	801300	5046	541	SAE	10	2	178	153						14	SAE 1 1/2" 10 C	double bent (short; R=65 mm)

SAE / SAURER / SCAMMEL / SEDDON ATKINSON / SICCA

SAE	5047	SAE	8760	SAE	8761
A		B		C	
	AYS CODE 801305		AYS CODE 802260		AYS CODE 802265
	PART NUMBER 79145		PART NUMBER 79142		PART NUMBER 79143
	OEM NO 9002225		OEM NO 9002251		OEM NO 9002252
SAE	475-20000	SAE	5027	SAE	5027
D		E		F	
	AYS CODE 803205		AYS CODE 803600		AYS CODE 803725
	PART NUMBER 70804		PART NUMBER 79148		PART NUMBER 72251
	OEM NO		OEM NO 9002281		OEM NO 4W1035
SAURER	475-20000	SCAMMEL	475-20000	SEDDON ATKINSON	5041
G		H		I	
	AYS CODE 803315		AYS CODE 802905		AYS CODE 800735
	PART NUMBER 70762		PART NUMBER 70573		PART NUMBER 72114
	OEM NO 4W2770		OEM NO		OEM NO 3291747R
SEDDON ATKINSON	475-20000	SICCA	475-20000	SICCA	475-20000
J		K		L	
	AYS CODE 803285		AYS CODE 802740		AYS CODE 802745
	PART NUMBER 72356		PART NUMBER 72419		PART NUMBER 70919
	OEM NO 914266		OEM NO S5004035		OEM NO S5001048

	AYS CODE	CASTING	CONTROL UNIT	APPLICATION	SPLINE TEETH	NO of HOLE	H1	H2	H3	H4	H5	H6	H7	BUSHING (mm)	SPLINE TYPE	CONTROL ARM
A	801305	5047	541	SAE	10	2	178	153						14	SAE 1 1/2" 10 C	double bent (short; R=65 mm)
B	802260	8760	541	SAE	10	2	178	153						14	SAE 1 1/2" 10 C	double bent (short; R=65 mm)
C	802265	8761	541	SAE	10	2	178	153						14	SAE 1 1/2" 10 C	double bent (short; R=65 mm)
D	803205	475-20000	527	SAE	10	4	210	180	150	120				14	SAE 1 1/2" 10 C	double bent (short; R=65 mm)
E	803600	5027	541	SAE	10	3	178	153	127					14	SAE 1 1/2" 10 C	double bent (short; R=65 mm)
F	803725	5027	529	SAE	27	4	210	180	150	125				14	BNA 227	bent
G	803315	475-20000	527	SAURER	19	2	180	135						14 (L2: x)	A38x34 DIN 5482	double bent (short; R=65 mm)
H	802905	475-20000	529	SCAMMEL	10	1	140							12,7	SAE 1 1/2" 10 C	bent
I	800735	5041	540	SEDDON ATKINSON	10	1	140							12,7	SAE 1 1/2" 10 C	double bent (long; R=100 mm)
J	803285	475-20000	527	SEDDON ATKINSON	19	1	150							14	A38x34 DIN 5482	double bent (short; R=65 mm)
K	802740	475-20000	541	SICCA	8	1	180							12,7	32 UNI 222	double bent (short; R=65 mm)
L	802745	475-20000	527	SICCA	8	1	180							12,7	32 UNI 222	double bent (short; R=65 mm)



* CS > Customer Specific / Özel İmalat

(SELF-SETTING) FULL AUTOMATIC PRODUCT TYPES ARE CONTINUOUSLY INCREASED.
PLEASE CONTACT WITH OUR MARKETING DEPARTMENT FOR FURTHER INFORMATIONS.
TAM OTOMATİK ÜRÜNLERİMİZ SÜREKLİ OLARAK ARTMAKTADIR. DETAYLI BİLGİ İÇİN
PAZARLAMA DEPARTMANI İLE İLETİŞİME GEÇİNİZ.









ALL ORIGINAL NUMBERS, MARKS AND MODELS FROM VEHICLE MANUFACTURERS
LISTED IN THIS CATALOGUE ARE FOR COMPARISON PURPOSES ONLY AND MAY NOT BE
USED IN INVOICES TO VEHICLE OWNERS OR RESELLERS / ORJINAL ÜRÜN NUMARALARI
MÜŞTERİYİ BİLGİLENDİRME VE ÜRÜNE REFERANS AMAÇLI KULLANILMIŞTIR.

SKODA / SMB / SOMAR PL / SOUTHAFRICA / STAR / STEER AXLE / STEFEN / STEYR

SKODA A	8083 AYS CODE 801660 PART NUMBER 79245 OEM NO	SKODA B	8084 AYS CODE 801665 PART NUMBER 79246 OEM NO	SMB C	5027 AYS CODE 800075 PART NUMBER 80023 OEM NO KB1025D
SOMAR PL D	8162 AYS CODE 801670 PART NUMBER 79635 OEM NO	SOMAR PL E	8163 AYS CODE 801675 PART NUMBER 79636 OEM NO	SOUTHAFRICA F	475-20000 AYS CODE 800275 PART NUMBER 80109 OEM NO
STAR G	475-20000 AYS CODE 803250 PART NUMBER 72896 OEM NO 12242	STEER AXLE H	8760 AYS CODE 802480 PART NUMBER 12112 OEM NO	STEER AXLE I	8761 AYS CODE 802485 PART NUMBER 12113 OEM NO
STEFEN J	8760 AYS CODE 802310 PART NUMBER 79028 OEM NO P17179028	STEFEN K	8761 AYS CODE 802315 PART NUMBER 79029 OEM NO P17179029	STEYR L	8760 AYS CODE 802450 PART NUMBER 72431 OEM NO 4W3635

	AYS CODE	CASTING	CONTROL UNIT	APPLICATION	SPLINE TEETH	NO of HOLE	H1	H2	H3	H4	H5	H6	H7	BUSHING (mm)	SPLINE TYPE	CONTROL ARM
A	801660	8083	529	SKODA	20	1	165							14	A40x36 DIN 5482	bent
B	801665	8084	529	SKODA	20	1	165							14	A40x36 DIN 5482	bent
C	800075	5027	530	SMB	10	4	215	153	129	105				14 (L1: 16)	SAE 1 1/2" 10 C	ays-saddle type
D	801670	8162	529	SOMAR PL	10	1	120							12	SAE 1 1/2" 10 C	bent
E	801675	8163	529	SOMAR PL	10	1	120							12	SAE 1 1/2" 10 C	bent
F	800275	475-20000	529	SOUTHAFRICA	10	1	140							12,7	SAE 1 1/2" 10 C	bent
G	803250	475-20000	527	STAR	18	1	102							14	N30x1,5x9H DIN 5480	double bent (short; R=65 mm)
H	802480	8760	529	STEER AXLE	37	3	203	179	151					14	SAE J 498	bent
I	802485	8761	529	STEER AXLE	37	3	203	179	151					14	SAE J 498	bent
J	802310	8760	541	STEFEN	10	3	203	179	151					14	SAE 1 1/2" 10 C	double bent (short; R=65 mm)
K	802315	8761	541	STEFEN	10	3	203	179	151					14	SAE 1 1/2" 10 C	double bent (short; R=65 mm)
L	802450	8760	529	STEYR	28	1	152							12,7	SAE 1 1/2" 28 C	bent

STEYR / TATRA / TELCO / TEMSA / TOKYO CAR

STEYR	8761	STEYR	475-20000	TATRA	8042
A		B		C	
	AYS CODE 802455		AYS CODE 802900		AYS CODE 801610
	PART NUMBER 72430		PART NUMBER 72149		PART NUMBER 79499
	OEM NO 4W3640		OEM NO R8819/F		OEM NO
TATRA	8043	TATRA	8760	TATRA	8761
D		E		F	
	AYS CODE 801615		AYS CODE 802410		AYS CODE 802415
	PART NUMBER 79500		PART NUMBER 79510		PART NUMBER 79511
	OEM NO		OEM NO		OEM NO
TELCO	5039	TELCO	5040	TEMSA	5041
G		H		I	
	AYS CODE 800260		AYS CODE 800265		AYS CODE 800860
	PART NUMBER 80106		PART NUMBER 80107		PART NUMBER 72585
	OEM NO		OEM NO		OEM NO
TEMSA	5044	TEMSA	5045	TOKYO CAR	5044
J		K		L	
	AYS CODE 801080		AYS CODE 801085		AYS CODE 801120
	PART NUMBER 72583		PART NUMBER 72584		PART NUMBER 79622
	OEM NO TC807634		OEM NO TC807635		OEM NO

	AYS CODE	CASTING	CONTROL UNIT	APPLICATION	SPLINE TEETH	NO of HOLE	H1	H2	H3	H4	H5	H6	H7	BUSHING (mm)	SPLINE TYPE	CONTROL ARM
A	802455	8761	529	STEYR	28	1	152							12,7	SAE 1 1/2" 28 C	bent
B	802900	475-20000	528	STEYR	10	1	140							12,7	SAE 1 1/2" 10 C	double bent (medium; R=78 mm)
C	801610	8042	529	TATRA	26	1	175							14	40x1,5 CSN 014950,1	bent
D	801615	8043	529	TATRA	26	1	175							14	40x1,5 CSN 014950,1	bent
E	802410	8760	529	TATRA	26	1	175							14	40x1,5 CSN 014950,1	bent
F	802415	8761	529	TATRA	26	1	175							14	40x1,5 CSN 014950,1	bent
G	800260	5039	531	TELCO	24	1	140							12,7	N38x1,5x9H DIN 5480	bent-Ø 8
H	800265	5040	531	TELCO	24	1	140							12,7	N38x1,5x9H DIN 5480	bent-Ø 8
I	800860	5041	528	TEMSA	25	1	135							14	JIS B 1602	double bent (medium; R=78 mm)
J	801080	5044	528	TEMSA	25	1	145							14	JIS B 1602	double bent (medium; R=78 mm)
K	801085	5045	528	TEMSA	25	1	145							14	JIS B 1602	double bent (medium; R=78 mm)
L	801120	5044	528	TOKYO CAR	25	2	185	155						12,7	JIS B 1602 L=29,4	double bent (medium; R=78 mm)





* CS > Customer Specific / Özel İmalat











(SELF-SETTING) FULL AUTOMATIC PRODUCT TYPES ARE CONTINUOUSLY INCREASED.
PLEASE CONTACT WITH OUR MARKETING DEPARTMENT FOR FURTHER INFORMATIONS.
TAM OTOMATİK ÜRÜNLERİMİZ SÜREKLİ OLARAK ARTMAKTADIR. DETAYLI BİLGİ İÇİN
PAZARLAMA DEPARTMANI İLE İLETİŞİME GEÇİNİZ.

ALL ORIGINAL NUMBERS, MARKS AND MODELS FROM VEHICLE MANUFACTURERS
LISTED IN THIS CATALOGUE ARE FOR COMPARISON PURPOSES ONLY AND MAY NOT BE
USED IN INVOICES TO VEHICLE OWNERS OR RESELLERS / ORJINAL ÜRÜN NUMARALARI
MÜŞTERİYİ BİLGİLENDİRME VE ÜRÜNE REFERANS AMAÇLI KULLANILMIŞTIR.

TOKYO CAR / TRAILOR / YORK / YOSOKI / ZF

A	TOKYO CAR	5045		AYS CODE 801125	PART NUMBER 79623	OEM NO
B	TRAILOR	5027		AYS CODE 800080	PART NUMBER 80024	OEM NO KB1015D
C	YORK	5037		AYS CODE 800535	PART NUMBER 79065	OEM NO
D	YORK	5038		AYS CODE 800540	PART NUMBER 79066	OEM NO
E	YOSOKI	475-20000		AYS CODE 803400	PART NUMBER 79626	OEM NO
F	ZF	5017		AYS CODE 800465	PART NUMBER 72688	OEM NO KB2785
G	ZF	5018		AYS CODE 800470	PART NUMBER 72689	OEM NO KB2790
H	ZF	5019		AYS CODE 800505	PART NUMBER 72854	OEM NO 4W2935
I	ZF	5020		AYS CODE 800510	PART NUMBER 72855	OEM NO 4W3065
J	ZF	5046		AYS CODE 801380	PART NUMBER 72930	OEM NO 4W3650
K	ZF	5047		AYS CODE 801385	PART NUMBER 79172	OEM NO
L	ZF	8042		AYS CODE 801600	PART NUMBER 79637	OEM NO 0003520840

	AYS CODE	CASTING	CONTROL UNIT	APPLICATION	SPLINE TEETH	NO of HOLE	H1	H2	H3	H4	H5	H6	H7	BUSHING (mm)	SPLINE TYPE	CONTROL ARM
A	801125	5045	528	TOKYO CAR	25	2	185	155						12,7	JIS B 1602 L=29,4	double bent (medium; R=78 mm)
B	800080	5027	530	TRAILOR	10	4	210	180	150	125				14	SAE 1 1/2" 10 C	ays-saddle type
C	800535	5037	529	YORK	10	1	140							14	SAE 1 1/2" 10 C	bent
D	800540	5038	529	YORK	10	1	140							14	SAE 1 1/2" 10 C	bent
E	803400	475-20000	528	YOSOKI	25	2	190	160						14	JIS B 1602 L=29,4	double bent (medium; R=78 mm)
F	800465	5017	527	ZF	19	1	145							14	A38x34 DIN 5482	double bent (short; R=65 mm)
G	800470	5018	527	ZF	19	1	145							14	A38x34 DIN 5482	double bent (short; R=65 mm)
H	800505	5019	527	ZF	19	1	145							14	A38x34 DIN 5482	double bent (short; R=65 mm)
I	800510	5020	527	ZF	19	1	145							14	A38x34 DIN 5482	double bent (short; R=65 mm)
J	801380	5046	527	ZF	19	1	152							14	A38x34 DIN 5482	double bent (short; R=65 mm)
K	801385	5047	527	ZF	19	1	152							14	A38x34 DIN 5482	double bent (short; R=65 mm)
L	801600	8042	527	ZF	19	1	145							14	A38x34 DIN 5482	double bent (short; R=65 mm)

ZF A 	8043 AYS CODE 801605 PART NUMBER 79638 OEM NO 0003520940	ZF B 	8900 AYS CODE 802570 PART NUMBER 72872 OEM NO 0501314043	ZF C 	8985 AYS CODE 802690 PART NUMBER 79613 OEM NO
ZF D 	8987 AYS CODE 802695 PART NUMBER 79614 OEM NO	ZF E 	475-20000 AYS CODE 803275 PART NUMBER 72385 OEM NO 501206318	ZF F 	475-20000 AYS CODE 803290 PART NUMBER 72330 OEM NO 4W2960
ZF AXLES G 	475-20000 AYS CODE 802930 PART NUMBER 72314 OEM NO	ZF AXLES H 	475-20000 AYS CODE 802955 PART NUMBER c.s. OEM NO	OTHERS I 	5027 AYS CODE 800085 PART NUMBER 80025 OEM NO
OTHERS J 	5027 AYS CODE 800105 PART NUMBER 80033 OEM NO	OTHERS K 	475-20000 AYS CODE 800110 PART NUMBER 80034 OEM NO	OTHERS L 	475-20000 AYS CODE 800115 PART NUMBER 80035 OEM NO

	AYS CODE	CASTING	CONTROL UNIT	APPLICATION	SPLINE TEETH	NO of HOLE	H1	H2	H3	H4	H5	H6	H7	BUSHING (mm)	SPLINE TYPE	CONTROL ARM
A	801605	8043	527	ZF	19	1	145							14	A38x34 DIN 5482	double bent (short; R=65 mm)
B	802570	8900	527	ZF	19	1	145							14	A38x34 DIN 5482	double bent (short; R=65 mm)
C	802690	8985	527	ZF	19	1	145							14	A38x34 DIN 5482	double bent (short; R=65 mm)
D	802695	8987	527	ZF	19	1	145							14	A38x34 DIN 5482	double bent (short; R=65 mm)
E	803275	475-20000	527	ZF	19	1	145							14	A38x34 DIN 5482	double bent (short; R=65 mm)
F	803290	475-20000	527	ZF	19	1	152							14	A38x34 DIN 5482	double bent (short; R=65 mm)
G	802930	475-20000	527	ZF AXLES	10	1	140							x	SAE 1 1/2" 10 C	double bent (short; R=65 mm)
H	802955	475-20000	527	ZF AXLES	10	1	150							14	SAE 1 1/2" 10 C	double bent (short; R=65 mm)
I	800085	5027	532		28	1	250							12	SAE 1 1/2" 28 C	double bent (short; R=65 mm)
J	800105	5027	532		37	3	180	155	130					14	SAE J 498	double bent (short; R=65 mm)
K	800110	475-20000	530		28	1	153							12,7	SAE 1 1/2" 28 C	ays-saddle type
L	800115	475-20000	530		28	1	153							16	SAE 1 1/2" 28 C	ays-saddle type

OTHERS

A		5027 AYS CODE 800140 PART NUMBER 80042 OEM NO	B		475-20000 AYS CODE 800145 PART NUMBER 80045 OEM NO	C		5027 AYS CODE 800155 PART NUMBER 80067 OEM NO
D		475-20000 AYS CODE 800160 PART NUMBER 80069 OEM NO	E		5039 AYS CODE 800165 PART NUMBER 80070 OEM NO	F		5040 AYS CODE 800170 PART NUMBER 80071 OEM NO
G		475-20000 AYS CODE 800175 PART NUMBER 80072 OEM NO	H		5037 AYS CODE 800180 PART NUMBER 80073 OEM NO	I		5038 AYS CODE 800185 PART NUMBER 80074 OEM NO
J		475-20000 AYS CODE 800190 PART NUMBER 80075 OEM NO	K		5037 AYS CODE 800195 PART NUMBER 80076 OEM NO	L		5038 AYS CODE 800200 PART NUMBER 80077 OEM NO

	AYS CODE	CASTING	CONTROL UNIT	APPLICATION	SPLINE TEETH	NO of HOLE	H1	H2	H3	H4	H5	H6	H7	BUSHING (mm)	SPLINE TYPE	CONTROL ARM
A	800140	5027	529		20	2	175	155						14	A40x36 DIN 5482	bent
B	800145	475-20000	531		10	1	160							12,7	SAE 1 1/2" 10 C	bent
C	800155	5027	530		10	5	250	180	150	130	110			14	SAE 1 1/2" 10 C	ays-saddle type
D	800160	475-20000	532		24	1	140							12,7	N32x1,25x24	double bent (short; R=65 mm)
E	800165	5039	532		24	1	140							12,7	N32x1,25x24	double bent (short; R=65 mm)
F	800170	5040	532		24	1	140							12,7	N32x1,25x24	double bent (short; R=65 mm)
G	800175	475-20000	531		24	1	140							12,7	N38x1,5x9H DIN 5480	bent
H	800180	5037	531		24	1	140							12,7	N38x1,5x9H DIN 5480	bent
I	800185	5038	531		24	1	140							12,7	N38x1,5x9H DIN 5480	bent
J	800190	475-20000	531		24	1	140							12,7	N32x1,25x24	bent
K	800195	5037	531		24	1	140							12,7	N32x1,25x24	bent
L	800200	5038	531		24	1	140							12,7	N32x1,25x24	bent

OTHERS	5027	OTHERS	5027	OTHERS	475-20000
A		B		C	
AYS CODE 800205	PART NUMBER 80078	AYS CODE 800210	PART NUMBER 80082	AYS CODE 800235	PART NUMBER 80089
OEM NO		OEM NO		OEM NO	
OTHERS	475-20000	OTHERS	5027	OTHERS	5027
D		E		F	
AYS CODE 800255	PART NUMBER 80095	AYS CODE 800305	PART NUMBER 80133	AYS CODE 800310	PART NUMBER 80134
OEM NO		OEM NO		OEM NO	
OTHERS	5027	OTHERS	5041	OTHERS	5017
G		H		I	
AYS CODE 800315	PART NUMBER 80135	AYS CODE 800320	PART NUMBER 80136	AYS CODE 800475	PART NUMBER c.s.
OEM NO		OEM NO		OEM NO	
OTHERS	5018	OTHERS	5037	OTHERS	5038
J		K		L	
AYS CODE 800480	PART NUMBER c.s.	AYS CODE 800545	PART NUMBER 79587	AYS CODE 800550	PART NUMBER 79588
OEM NO		OEM NO		OEM NO	

	AYS CODE	CASTING	CONTROL UNIT	APPLICATION	SPLINE TEETH	NO of HOLE	H1	H2	H3	H4	H5	H6	H7	BUSHING (mm)	SPLINE TYPE	CONTROL ARM
A	800205	5027	530		26	4	180	155	140	125				14	N42x1,5x9H DIN 5480	ays-saddle type
B	800210	5027	530		10	2	125	105						12,7	SAE 1 1/2" 10 C	ays-saddle type
C	800235	475-20000	529		10	1	160							12,7	SAE 1 1/2" 10 C	bent
D	800255	475-20000	527		25	1	150							16	JIS B 1602	double bent (short; R=65 mm)
E	800305	5027	530		10	1	127,5							14	SAE 1 1/2" 10 C	ays-saddle type
F	800310	5027	534		10	6	180	165	150	135	120	105		14	SAE 1 1/2" 10 C	double bent (short; R=65 mm)
G	800315	5027	530		10	2	148	100						14	SAE 1 1/2" 10 C	ays-saddle type
H	800320	5041	527		10	2	180	150						14	SAE 1 1/2" 10 C	double bent (short; R=65 mm)
I	800475	5017	527		28	1	145							14	SAE 1 1/2" 28 C	double bent (short; R=65 mm)
J	800480	5018	527		28	1	145							14	SAE 1 1/2" 28 C	double bent (short; R=65 mm)
K	800545	5037	530		10	1	140							14	SAE 1 1/2" 10 C	ays-saddle type
L	800550	5038	530		10	1	140							14	SAE 1 1/2" 10 C	ays-saddle type

OTHERS



OTHERS	5037	OTHERS	5038	OTHERS	5039
A		B		C	
	AYS CODE 800625		AYS CODE 800630		AYS CODE 800645
	PART NUMBER 79238		PART NUMBER 79239		PART NUMBER 79575
	OEM NO		OEM NO		OEM NO
OTHERS	5040	OTHERS	5039	OTHERS	5040
D		E		F	
	AYS CODE 800650		AYS CODE 800655		AYS CODE 800660
	PART NUMBER 79576		PART NUMBER 79567		PART NUMBER 79568
	OEM NO		OEM NO		OEM NO
OTHERS	5039	OTHERS	5040	OTHERS	5039
G		H		I	
	AYS CODE 800665		AYS CODE 800670		AYS CODE 800695
	PART NUMBER 79375		PART NUMBER 79376		PART NUMBER 79472
	OEM NO		OEM NO		OEM NO
OTHERS	5040	OTHERS	5041	OTHERS	5041
J		K		L	
	AYS CODE 800700		AYS CODE 800820		AYS CODE 800825
	PART NUMBER 79473		PART NUMBER 79353		PART NUMBER 72820
	OEM NO		OEM NO		OEM NO

	AYS CODE	CASTING	CONTROL UNIT	APPLICATION	SPLINE TEETH	NO of HOLE	H1	H2	H3	H4	H5	H6	H7	BUSHING (mm)	SPLINE TYPE	CONTROL ARM
A	800625	5037	529		26	1	175							14	40x1,5 CSN 014950,1	bent
B	800630	5038	529		26	1	175							14	40x1,5 CSN 014950,1	bent
C	800645	5039	527		10	1	130							12	SAE 1 1/2" 10 C	double bent (short; R=65 mm)
D	800650	5040	527		10	1	130							12	SAE 1 1/2" 10 C	double bent (short; R=65 mm)
E	800655	5039	529		10	1	130							12	SAE 1 1/2" 10 C	bent
F	800660	5040	529		10	1	130							12	SAE 1 1/2" 10 C	bent
G	800665	5039	528		19	1	130							14	A38x34 DIN 5482	double bent (medium; R=78 mm)
H	800670	5040	528		19	1	130							14	A38x34 DIN 5482	double bent (medium; R=78 mm)
I	800695	5039	527		19	1	152							16	A38x34 DIN 5482	double bent (short; R=65 mm)
J	800700	5040	527		19	1	152							16	A38x34 DIN 5482	double bent (short; R=65 mm)
K	800820	5041	529		14	1	135							12	JIS D 2001 (40x14)	bent
L	800825	5041	527		14	1	150							12,7	JIS D 2001 (40x14)	double bent (short; R=65 mm)

A	OTHERS	5041		AYS CODE 800835	PART NUMBER 79390	OEM NO
B	OTHERS	5045		AYS CODE 800920	PART NUMBER 72712	OEM NO
C	OTHERS	5044		AYS CODE 800935	PART NUMBER 72344	OEM NO
D	OTHERS	5045		AYS CODE 800940	PART NUMBER 72345	OEM NO
E	OTHERS	5044		AYS CODE 800945	PART NUMBER 79447	OEM NO
F	OTHERS	5045		AYS CODE 800950	PART NUMBER 79448	OEM NO
G	OTHERS	5044		AYS CODE 800985	PART NUMBER 72818	OEM NO
H	OTHERS	5045		AYS CODE 800990	PART NUMBER 72819	OEM NO
I	OTHERS	5044		AYS CODE 800995	PART NUMBER 11031	OEM NO
J	OTHERS	5045		AYS CODE 801000	PART NUMBER 11032	OEM NO
K	OTHERS	5044		AYS CODE 801015	PART NUMBER 10283	OEM NO
L	OTHERS	5045		AYS CODE 801020	PART NUMBER 10284	OEM NO

	AYS CODE	CASTING	CONTROL UNIT	APPLICATION	SPLINE TEETH	NO of HOLE	H1	H2	H3	H4	H5	H6	H7	BUSHING (mm)	SPLINE TYPE	CONTROL ARM
A	800835	5041	529		20	1	140							14	A40x36 DIN 5482	bent
B	800920	5045	528		8	1	180							14	32 UNI 222	double bent (medium; R=78 mm)
C	800935	5044	528		10	1	151							12,7	SAE 1 1/2" 10 C	double bent (medium; R=78 mm)
D	800940	5045	528		10	1	151							12,7	SAE 1 1/2" 10 C	double bent (medium; R=78 mm)
E	800945	5044	541		10	1	165							14	SAE 1 1/2" 10 C	double bent (short; R=65 mm)
F	800950	5045	541		10	1	165							14	SAE 1 1/2" 10 C	double bent (short; R=65 mm)
G	800985	5044	527		12	1	150							12,7	JIS D 2001 (35x12)	double bent (short; R=65 mm)
H	800990	5045	527		12	1	150							12,7	JIS D 2001 (35x12)	double bent (short; R=65 mm)
I	800995	5044	529		12	1	150							12,7	JIS D 2001 (35x12)	bent
J	801000	5045	529		12	1	150							12,7	JIS D 2001 (35x12)	bent
K	801015	5044	529		19	1	150							12,7	A38x34 DIN 5482	bent
L	801020	5045	529		19	1	150							12,7	A38x34 DIN 5482	bent

OTHERS

A		5044 AYS CODE 801025 PART NUMBER 79422 OEM NO	B		5045 AYS CODE 801030 PART NUMBER 79423 OEM NO	C		5044 AYS CODE 801090 PART NUMBER 79414 OEM NO
D		5045 AYS CODE 801095 PART NUMBER 79415 OEM NO	E		5044 AYS CODE 801110 PART NUMBER 79480 OEM NO	F		5045 AYS CODE 801115 PART NUMBER 79481 OEM NO
G		5044 AYS CODE 801130 PART NUMBER 79558 OEM NO	H		5045 AYS CODE 801135 PART NUMBER 79559 OEM NO	I		5044 AYS CODE 801140 PART NUMBER 79377 OEM NO
J		5045 AYS CODE 801145 PART NUMBER 79378 OEM NO	K		5044 AYS CODE 801160 PART NUMBER 79262 OEM NO	L		5045 AYS CODE 801165 PART NUMBER 79263 OEM NO

	AYS CODE	CASTING	CONTROL UNIT	APPLICATION	SPLINE TEETH	NO of HOLE	H1	H2	H3	H4	H5	H6	H7	BUSHING (mm)	SPLINE TYPE	CONTROL ARM
A	801025	5044	527		19	1	150							12,7	A38x34 DIN 5482	double bent (short; R=65 mm)
B	801030	5045	527		19	1	150							12,7	A38x34 DIN 5482	double bent (short; R=65 mm)
C	801090	5044	529		25	1	150							16	JIS B 1602	bent
D	801095	5045	529		25	1	150							16	JIS B 1602	bent
E	801110	5044	529		25	1	150							16	JIS B 1602	bent
F	801115	5045	529		25	1	150							16	JIS B 1602	bent
G	801130	5044	530		26	1	150							14	40x1,5 CSN 014950,1	ays-saddle type
H	801135	5045	530		26	1	150							14	40x1,5 CSN 014950,1	ays-saddle type
I	801140	5044	527		26	1	155							14	40x1,5 CSN 014950,1	double bent (short; R=65 mm)
J	801145	5045	527		26	1	155							14	40x1,5 CSN 014950,1	double bent (short; R=65 mm)
K	801160	5044	529		26	1	175							14	40x1,5 CSN 014950,1	bent
L	801165	5045	529		26	1	175							14	40x1,5 CSN 014950,1	bent

OTHERS	5046	OTHERS	5047	OTHERS	5046
A		B		C	
	AYS CODE 801230		AYS CODE 801235		AYS CODE 801260
	PART NUMBER 72821		PART NUMBER 72707		PART NUMBER 79528
	OEM NO		OEM NO Y730111		OEM NO
OTHERS	5047	OTHERS	5047	OTHERS	5046
D		E		F	
	AYS CODE 801265		AYS CODE 801295		AYS CODE 801370
	PART NUMBER 79529		PART NUMBER 79248		PART NUMBER 79188
	OEM NO		OEM NO		OEM NO
OTHERS	5047	OTHERS	5046	OTHERS	5047
G		H		I	
	AYS CODE 801375		AYS CODE 801440		AYS CODE 801445
	PART NUMBER 79189		PART NUMBER 12243		PART NUMBER 12244
	OEM NO		OEM NO		OEM NO
OTHERS	8037	OTHERS	8037	OTHERS	8042
J		K		L	
	AYS CODE 801565		AYS CODE 801575		AYS CODE 801620
	PART NUMBER c.s.		PART NUMBER c.s.		PART NUMBER 79530
	OEM NO		OEM NO		OEM NO

	AYS CODE	CASTING	CONTROL UNIT	APPLICATION	SPLINE TEETH	NO of HOLE	H1	H2	H3	H4	H5	H6	H7	BUSHING (mm)	SPLINE TYPE	CONTROL ARM
A	801230	5046	529		10	1	152							14	SAE 1 1/2" 10 C	bent
B	801235	5047	529		10	1	152							14	SAE 1 1/2" 10 C	bent
C	801260	5046	529		10	1	165							12,7	SAE 1 1/2" 10 C	bent
D	801265	5047	529		10	1	165							12,7	SAE 1 1/2" 10 C	bent
E	801295	5047	530		10	1	178							14	SAE 1 1/2" 10 C	ays-saddle type
F	801370	5046	529		19	1	150							12,7	A38x34 DIN 5482	bent
G	801375	5047	529		19	1	150							12,7	A38x34 DIN 5482	bent
H	801440	5046	529		26	1	140							14	40x1,5 CSN 014950,1	bent
I	801445	5047	529		26	1	140							14	40x1,5 CSN 014950,1	bent
J	801565	8037	527		10	1	115							14	SAE 1 1/2" 10 C	double bent (short; R=65 mm)
K	801575	8037	530		10	1	130							14	SAE 1 1/2" 10 C	ays-saddle type
L	801620	8042	529		28	1	145							16	SAE 1 1/2" 28 C	bent

OTHERS







A	OTHERS	8043		OTHERS	8162		OTHERS	8163	
		AYS CODE 801625			AYS CODE 801690			AYS CODE 801695	
		PART NUMBER 79531			PART NUMBER c.s.			PART NUMBER c.s.	
		OEM NO			OEM NO			OEM NO	
D	OTHERS	8177		OTHERS	8185		OTHERS	8186	
		AYS CODE 801730			AYS CODE 801775			AYS CODE 801780	
		PART NUMBER c.s.			PART NUMBER 79231			PART NUMBER 79232	
		OEM NO			OEM NO			OEM NO	
G	OTHERS	8717		OTHERS	8718		OTHERS	8760	
		AYS CODE 801945			AYS CODE 801950			AYS CODE 802030	
		PART NUMBER 79404			PART NUMBER 79405			PART NUMBER 79589	
		OEM NO			OEM NO			OEM NO	
J	OTHERS	8761		OTHERS	8760		OTHERS	8761	
		AYS CODE 802035			AYS CODE 802150			AYS CODE 802155	
		PART NUMBER 79590			PART NUMBER 12116			PART NUMBER 12117	
		OEM NO			OEM NO			OEM NO	

	AYS CODE	CASTING	CONTROL UNIT	APPLICATION	SPLINE TEETH	NO of HOLE	H1	H2	H3	H4	H5	H6	H7	BUSHING (mm)	SPLINE TYPE	CONTROL ARM
A	801625	8043	529		28	1	145							16	SAE 1 1/2" 28 C	bent
B	801690	8162	528		10	1	145							14	SAE 1 1/2" 10 C	double bent (medium; R=78 mm)
C	801695	8163	528		10	1	145							14	SAE 1 1/2" 10 C	double bent (medium; R=78 mm)
D	801730	8177	528		10	1	145							14	SAE 1 1/2" 10 C	double bent (medium; R=78 mm)
E	801775	8185	528		19	1	145							14	A38x34 DIN 5482	double bent (medium; R=78 mm)
F	801780	8186	528		19	1	145							14	A38x34 DIN 5482	double bent (medium; R=78 mm)
G	801945	8717	528		27	1	175							14	BNA 227, Ø 35,0	double bent (short; R=65 mm)
H	801950	8718	528		27	1	175							14	BNA 227, Ø 35,0	double bent (short; R=65 mm)
I	802030	8760	530		10	1	140							14	SAE 1 1/2" 10 C	ays-saddle type
J	802035	8761	530		10	1	140							14	SAE 1 1/2" 10 C	ays-saddle type
K	802150	8760	527		10	1	152							14	SAE 1 1/2" 10 C	double bent (short; R=65 mm)
L	802155	8761	527		10	1	152							14	SAE 1 1/2" 10 C	double bent (short; R=65 mm)

OTHERS	8760	OTHERS	8761	OTHERS	8760
A		B		C	
	AYS CODE 802230		AYS CODE 802235		AYS CODE 802270
	PART NUMBER 79483		PART NUMBER 79484		PART NUMBER 79495
	OEM NO		OEM NO		OEM NO
OTHERS	8761	OTHERS	8760	OTHERS	8761
D		E		F	
	AYS CODE 802275		AYS CODE 802360		AYS CODE 802365
	PART NUMBER 79496		PART NUMBER 79537		PART NUMBER 79538
	OEM NO		OEM NO		OEM NO
OTHERS	8860	OTHERS	8861	OTHERS	8860
G		H		I	
	AYS CODE 802500		AYS CODE 802505		AYS CODE 802510
	PART NUMBER c.s.		PART NUMBER c.s.		PART NUMBER c.s.
	OEM NO		OEM NO		OEM NO
OTHERS	8861	OTHERS	8860	OTHERS	8861
J		K		L	
	AYS CODE 802515		AYS CODE 802530		AYS CODE 802535
	PART NUMBER c.s.		PART NUMBER c.s.		PART NUMBER c.s.
	OEM NO		OEM NO		OEM NO

	AYS CODE	CASTING	CONTROL UNIT	APPLICATION	SPLINE TEETH	NO of HOLE	H1	H2	H3	H4	H5	H6	H7	BUSHING (mm)	SPLINE TYPE	CONTROL ARM
A	802230	8760	529		10	1	165							14	SAE 1 1/2" 10 C	bent
B	802235	8761	529		10	1	165							14	SAE 1 1/2" 10 C	bent
C	802270	8760	527		10	2	179	140						14	SAE 1 1/2" 10 C	double bent (short; R=65 mm)
D	802275	8761	527		10	2	179	140						14	SAE 1 1/2" 10 C	double bent (short; R=65 mm)
E	802360	8760	527		19	1	155							14	A38x34 DIN 5482	double bent (short; R=65 mm)
F	802365	8761	527		19	1	155							14	A38x34 DIN 5482	double bent (short; R=65 mm)
G	802500	8860	527		10	1	145							12,7	SAE 1 1/2" 10 C	double bent (short; R=65 mm)
H	802505	8861	527		10	1	145							12,7	SAE 1 1/2" 10 C	double bent (short; R=65 mm)
I	802510	8860	528		10	1	145							12,7	SAE 1 1/2" 10 C	double bent (medium; R=78 mm)
J	802515	8861	528		10	1	145							12,7	SAE 1 1/2" 10 C	double bent (medium; R=78 mm)
K	802530	8860	528		26	1	145							12,7	N42x1,5x9H DIN 5480	double bent (medium; R=78 mm)
L	802535	8861	528		26	1	145							12,7	N42x1,5x9H DIN 5480	double bent (medium; R=78 mm)

OTHERS

A		8860 AYS CODE 802550 PART NUMBER C.S. OEM NO	B		8861 AYS CODE 802555 PART NUMBER C.S. OEM NO	C		8900 AYS CODE 802560 PART NUMBER C.S. OEM NO
D		8900 AYS CODE 802565 PART NUMBER 79562 OEM NO	E		8985 AYS CODE 802650 PART NUMBER 79471 OEM NO	F		8987 AYS CODE 802655 PART NUMBER 79470 OEM NO
G		8985 AYS CODE 802700 PART NUMBER 79691 OEM NO	H		8987 AYS CODE 802705 PART NUMBER 79692 OEM NO	I		475-20000 AYS CODE 802710 PART NUMBER 79233 OEM NO
J		475-20000 AYS CODE 802795 PART NUMBER 72454 OEM NO	K		475-20000 AYS CODE 802800 PART NUMBER 12360 OEM NO	L		475-20000 AYS CODE 802810 PART NUMBER 79370 OEM NO

	AYS CODE	CASTING	CONTROL UNIT	APPLICATION	SPLINE TEETH	NO of HOLE	H1	H2	H3	H4	H5	H6	H7	BUSHING (mm)	SPLINE TYPE	CONTROL ARM
A	802550	8860	527		26	1	145							14	N42x1,5x9H DIN 5480	double bent (short; R=65 mm)
B	802555	8861	527		26	1	145							14	N42x1,5x9H DIN 5480	double bent (short; R=65 mm)
C	802560	8900	527		10	1	145							14	SAE 1 1/2" 10 C	double bent (short; R=65 mm)
D	802565	8900	529		10	1	125							12	SAE 1 1/2" 10 C	bent
E	802650	8985	529		10	1	165							14	SAE 1 1/2" 10 C	bent
F	802655	8987	529		10	1	165							14	SAE 1 1/2" 10 C	bent
G	802700	8985	529		26	1	179							12	40x1,5 CSN 014950,1	bent
H	802705	8987	529		26	1	179							12	40x1,5 CSN 014950,1	bent
I	802710	475-20000	529		8	1	122							14	32 UNI 222	bent
J	802795	475-20000	529		10	1	115							12,7	SAE 1 1/2" 10 C	bent
K	802800	475-20000	527		10	1	125							12,7	SAE 1 1/2" 10 C	double bent (short; R=65 mm)
L	802810	475-20000	530		10	2	125	100						12	SAE 1 1/2" 10 C	ays-saddle type

A	OTHERS	475-20000		OTHERS	475-20000		OTHERS	8760
			AYS CODE 802815			AYS CODE 802825		AYS CODE 802860
			PART NUMBER 79569			PART NUMBER 10911		PART NUMBER 79449
			OEM NO			OEM NO		OEM NO
D	OTHERS	8761		OTHERS	475-20000		OTHERS	475-20000
			AYS CODE 802865			AYS CODE 802870		AYS CODE 802875
			PART NUMBER 79450			PART NUMBER 72735		PART NUMBER 79517
			OEM NO			OEM NO		OEM NO
G	OTHERS	475-20000		OTHERS	475-20000		OTHERS	475-20000
			AYS CODE 802945			AYS CODE 802965		AYS CODE 803005
			PART NUMBER 79361			PART NUMBER c.s.		PART NUMBER 70788
			OEM NO			OEM NO		OEM NO
J	OTHERS	475-20000		OTHERS	475-20000		OTHERS	475-20000
			AYS CODE 803010			AYS CODE 803020		AYS CODE 803050
			PART NUMBER 10912			PART NUMBER 12196		PART NUMBER 79458
			OEM NO			OEM NO		OEM NO

	AYS CODE	CASTING	CONTROL UNIT	APPLICATION	SPLINE TEETH	NO of HOLE	H1	H2	H3	H4	H5	H6	H7	BUSHING (mm)	SPLINE TYPE	CONTROL ARM
A	802815	475-20000	527		10	1	125							12	SAE 1 1/2" 10 C	double bent (short; R=65 mm)
B	802825	475-20000	532		10	1	127							12,7	SAE 1 1/2" 10 C	double bent (short; R=65 mm)
C	802860	8760	541		10	1	165							14	SAE 1 1/2" 10 C	double bent (short; R=65 mm)
D	802865	8761	541		10	1	165							14	SAE 1 1/2" 10 C	double bent (short; R=65 mm)
E	802870	475-20000	527		10	1	133							16	SAE 1 1/2" 10 C	double bent (short; R=65 mm)
F	802875	475-20000	528		10	1	140							12	SAE 1 1/2" 10 C	double bent (medium; R=78 mm)
G	802945	475-20000	527		10	1	145							14	SAE 1 1/2" 10 C	double bent (short; R=65 mm)
H	802965	475-20000	528		10	1	150							14	SAE 1 1/2" 10 C	double bent (medium; R=78 mm)
I	803005	475-20000	527		10	1	152							16	SAE 1 1/2" 10 C	double bent (short; R=65 mm)
J	803010	475-20000	528		10	1	152							16	SAE 1 1/2" 10 C	double bent (long; R=100 mm)
K	803020	475-20000	529		10	1	152							16	SAE 1 1/2" 10 C	bent
L	803050	475-20000	528		10	1	165							12,7	SAE 1 1/2" 10 C	double bent (medium; R=78 mm)













* CS > Customer Specific / Özel İmalat













(SELF-SETTING) FULL AUTOMATIC PRODUCT TYPES ARE CONTINUOUSLY INCREASED.
PLEASE CONTACT WITH OUR MARKETING DEPARTMENT FOR FURTHER INFORMATIONS.
TAM OTOMATİK ÜRÜNLERİMİZ SÜREKLİ OLARAK ARTMAKTADIR. DETAYLI BİLGİ İÇİN
PAZARLAMA DEPARTMANI İLE İLETİŞİME GEÇİNİZ.

ALL ORIGINAL NUMBERS, MARKS AND MODELS FROM VEHICLE MANUFACTURERS
LISTED IN THIS CATALOGUE ARE FOR COMPARISON PURPOSES ONLY AND MAY NOT BE
USED IN INVOICES TO VEHICLE OWNERS OR RESELLERS. / ORJINAL ÜRÜN NUMARALARI
MÜŞTERİYİ BİLGİLENDİRME VE ÜRÜNE REFERANS AMAÇLI KULLANILMIŞTIR.

OTHERS

A		OTHERS	475-20000	AYS CODE 803060	PART NUMBER 79285	OEM NO
B		OTHERS	475-20000	AYS CODE 803110	PART NUMBER 70752	OEM NO
C		OTHERS	475-20000	AYS CODE 803130	PART NUMBER 79424	OEM NO
D		OTHERS	475-20000	AYS CODE 803140	PART NUMBER 79277	OEM NO
E		OTHERS	475-20000	AYS CODE 803160	PART NUMBER 79457	OEM NO
F		OTHERS	475-20000	AYS CODE 803220	PART NUMBER 79354	OEM NO
G		OTHERS	475-20000	AYS CODE 803225	PART NUMBER 79437	OEM NO
H		OTHERS	475-20000	AYS CODE 803230	PART NUMBER 79460	OEM NO
I		OTHERS	475-20000	AYS CODE 803235	PART NUMBER 79436	OEM NO
J		OTHERS	475-20000	AYS CODE 803240	PART NUMBER 79533	OEM NO
K		OTHERS	475-20000	AYS CODE 803245	PART NUMBER 79427	OEM NO
L		OTHERS	475-20000	AYS CODE 803260	PART NUMBER 79230	OEM NO

	AYS CODE	CASTING	CONTROL UNIT	APPLICATION	SPLINE TEETH	NO of HOLE	H1	H2	H3	H4	H5	H6	H7	BUSHING (mm)	SPLINE TYPE	CONTROL ARM
A	803060	475-20000	540		10	1	165							14	SAE 1 1/2" 10 C	double bent (long; R=100 mm)
B	803110	475-20000	544		10	1	180							14	SAE 1 1/2" 10 C	double bent (short; R=65 mm)
C	803130	475-20000	530		10	3	190	165	140					12,7	SAE 1 1/2" 10 C	ays-saddle type
D	803140	475-20000	530		10	3	190	160	130					12,7	SAE 1 1/2" 10 C	ays-saddle type
E	803160	475-20000	530		10	3	200	175	150					12,7	SAE 1 1/2" 10 C	ays-saddle type
F	803220	475-20000	529		14	1	120							12	JIS D 2001 (40x14)	bent
G	803225	475-20000	528		14	1	150							12,7	JIS D 2001 (40x14)	double bent (medium; R=78 mm)
H	803230	475-20000	529		14	1	150							12,7	JIS D 2001 (40x14)	bent
I	803235	475-20000	529		14	1	150							12,7	JIS D 2001 (40x14)	bent
J	803240	475-20000	529		14	1	180							12,7	JIS D 2001 (40x14)	bent
K	803245	475-20000	529		14	2	190	150						12,7 (L1: 14)	JIS D 2001 (40x14)	bent
L	803260	475-20000	529		19	1	122							14	A38x34 DIN 5482	bent









OTHERS	475-20000	OTHERS	475-20000	OTHERS	475-20000
A		B		C	
	AYS CODE 803325		AYS CODE 803330		AYS CODE 803335
	PART NUMBER 79532		PART NUMBER c.s.		PART NUMBER c.s.
	OEM NO		OEM NO		OEM NO
OTHERS	475-20000	OTHERS	475-20000	OTHERS	475-20000
D		E		F	
	AYS CODE 803355		AYS CODE 803375		AYS CODE 803385
	PART NUMBER c.s.		PART NUMBER 79482		PART NUMBER 79541
	OEM NO		OEM NO		OEM NO
OTHERS	475-20000	OTHERS	475-20000	OTHERS	475-20000
G		H		I	
	AYS CODE 803390		AYS CODE 803395		AYS CODE 803405
	PART NUMBER 79595		PART NUMBER 79545		PART NUMBER 79255
	OEM NO		OEM NO		OEM NO
OTHERS	475-20000	OTHERS	475-20000	OTHERS	475-20000
J		K		L	
	AYS CODE 803440		AYS CODE 803450		AYS CODE 803475
	PART NUMBER 72964		PART NUMBER 79061		PART NUMBER 72699
	OEM NO		OEM NO		OEM NO

	AYS CODE	CASTING	CONTROL UNIT	APPLICATION	SPLINE TEETH	NO of HOLE	H1	H2	H3	H4	H5	H6	H7	BUSHING (mm)	SPLINE TYPE	CONTROL ARM
A	803325	475-20000	529		19	2	190	150						12,7 (L1: 14)	A38x34 DIN 5482	bent
B	803330	475-20000	527		20	1	130							14	A40x36 DIN 5482	double bent (short; R=65 mm)
C	803335	475-20000	528		20	1	145							14	A40x36 DIN 5482	double bent (medium; R=78 mm)
D	803355	475-20000	527		24	2	130	105						12,7	SAE 1 1/4" 24 C	double bent (short; R=65 mm)
E	803375	475-20000	529		25	1	150							16	JIS B 1602	bent
F	803385	475-20000	528		25	2	155	129						12,7	JIS B 1602 L=29,4	double bent (medium; R=78 mm)
G	803390	475-20000	528		25	3	185	155	129					12,7	JIS B 1602 L=29,4	double bent (medium; R=78 mm)
H	803395	475-20000	528		25	3	185	155	129					12,7	JIS B 1602 L=29,4	double bent (medium; R=78 mm)
I	803405	475-20000	528		25	3	190	160	130					14	JIS B 1602	double bent (medium; R=78 mm)
J	803440	475-20000	527		26	1	160							14	40x1,5 CSN 014950,1	double bent (short; R=65 mm)
K	803450	475-20000	527		26	1	170							14	40x1,5 CSN 014950,1	double bent (short; R=65 mm)
L	803475	475-20000	529		10	2	152	127						12,7	SAE 1 1/2" 10 C	bent

OTHERS

A		OTHERS	475-20000	OTHERS	475-20000	OTHERS	475-20000
			AYS CODE 803480		AYS CODE 803490		AYS CODE 803495
			PART NUMBER 12320		PART NUMBER c.s.		PART NUMBER 72769
			OEM NO		OEM NO		OEM NO
D		OTHERS	475-20000	E		OTHERS	5027
			AYS CODE 803510				AYS CODE 803595
			PART NUMBER 79274				PART NUMBER 79620
			OEM NO				OEM NO
G		OTHERS	5027	H		OTHERS	5027
			AYS CODE 803690				AYS CODE 803715
			PART NUMBER c.s.				PART NUMBER c.s.
			OEM NO				OEM NO
I		OTHERS	5027	J		OTHERS	5027
			AYS CODE 803720				AYS CODE 803750
			PART NUMBER 72582				PART NUMBER 72281
			OEM NO				OEM NO
K		OTHERS	5027	L		OTHERS	5027
			AYS CODE 803715				AYS CODE 803770
			PART NUMBER c.s.				PART NUMBER 72861
			OEM NO				OEM NO
			AYS CODE 803750				AYS CODE 803770
			PART NUMBER 72281				PART NUMBER 72273
			OEM NO				OEM NO

	AYS CODE	CASTING	CONTROL UNIT	APPLICATION	SPLINE TEETH	NO of HOLE	H1	H2	H3	H4	H5	H6	H7	BUSHING (mm)	SPLINE TYPE	CONTROL ARM
A	803480	475-20000	529		28	1	130							12,7	SAE 1 1/2" 28 C	bent
B	803490	475-20000	527		28	1	140							12,7	SAE 1 1/2" 28 C	double bent (short; R=65 mm)
C	803495	475-20000	529		28	1	140							12,7	SAE 1 7/16" 28 C	bent
D	803510	475-20000	529		28	2	152	127						12,7	SAE 1 1/2" 28 C	bent
E	803595	5027	527		10	1	125							12,7	SAE 1 1/2" 10 C	double bent (short; R=65 mm)
F	803630	5027	530		10	5	205	153	140	127	115			12,7	SAE 1 1/2" 10 C	ays-saddle type
G	803690	5027	527		10	6	250	180	155	140	125	105		14	SAE 1 1/2" 10 C	double bent (short; R=65 mm)
H	803715	5027	530		26	6	250	180	155	140	125	105		14	N42x1,5x9H DIN 5480	ays-saddle type
I	803720	5027	529		26	5	215	181	153	129	105			12,7	N42x1,5x9H DIN 5480	bent
J	803750	5027	529		28	5	215	181	153	129	105			12,7	SAE 1 1/2" 28 C	bent
K	803755	5027	529		36	6	250	180	165	150	135	120		14	A30x34 DIN 5481	bent
L	803770	5027	529		37	5	215	181	153	129	105			12,7	SAE J 498	bent

OTHERS	5027	OTHERS	5027	OTHERS	5041
A		B		C	
	AYS CODE 803780		AYS CODE 803785		AYS CODE 803790
	PART NUMBER 72272		PART NUMBER 72789		PART NUMBER 79247
	OEM NO		OEM NO		OEM NO
OTHERS	475-20000	OTHERS	5041	OTHERS	5027
D		E		F	
	AYS CODE 803810		AYS CODE 803820		AYS CODE 803830
	PART NUMBER 80200		PART NUMBER c.s.		PART NUMBER c.s.
	OEM NO		OEM NO		OEM NO
OTHERS	5027	OTHERS	5027		
G		H			
	AYS CODE 803840		AYS CODE 803850		
	PART NUMBER 80333		PART NUMBER c.s.		
	OEM NO		OEM NO		

	AYS CODE	CASTING	CONTROL UNIT	APPLICATION	SPLINE TEETH	NO of HOLE	H1	H2	H3	H4	H5	H6	H7	BUSHING (mm)	SPLINE TYPE	CONTROL ARM
A	803780	5027	529		10	1	250							x	SAE 1 1/2" 10 C	bent
B	803785	5027	529		37	5	215	181	153	129	105			14	A36x40 DIN 5481	bent
C	803790	5041	529		28	1	140							16	SAE 1 1/2" 28 C	bent
D	803810	475-20000	532		24	1	127							12,7	N32x1,25x24	double bent (short; R=65 mm)
E	803820	5041	527		10	1	125							12,7	SAE 1 1/2" 10 C	double bent (short; R=65 mm)
F	803830	5027	530		10	2	152	127						14	SAE 1 1/2" 10 C	ays-saddle type
G	803840	5027	531		25	1	140							12,7	SAE 1 1/2" 10 C	bent-Ø 8
H	803850	5027	530		10	2	165	140						12,7	SAE 1 1/2" 10 C	ays-saddle type
I																
J																
K																
L																

REPAIR KITS & CONTROL UNITS / TAMİR TAKIMLARI & KAPAKLAR



AYS CODE 200080 (2 POSITION)

AYS CODE 200081 (4 POSITION)

AYS CODE 200082 (6 POSITION)



AYS CODE 100527

AYS CODE 100528

AYS CODE 100529

AYS CODE 100530



AYS CODE 100531

AYS CODE 100532

AYS CODE 100535

AYS CODE 100536



AYS CODE 100537

AYS CODE 100540

AYS CODE 100541

AYS CODE 100542



AYS CODE 100543

AYS CODE 100544

AYS CODE 100545

AYS CODE 100546

AYS CODE - PART NUMBER

AYS CODE	PART NUMBER	PAGE NO	AYS CODE	PART NUMBER	PAGE NO	AYS CODE	PART NUMBER	PAGE NO	AYS CODE	PART NUMBER	PAGE NO
800005	70952	18	800070	79240	39	800280	80124	65	800615	79094	42
800005	72013	18	800070	79326	39	800285	80125	66	800620	79095	42
800005	72617	18	800070	79330	39	800290	80126	66	800625	79238	74
800005	79074	18	800070	79331	39	800295	79270	66	800630	79239	74
800005	79206	18	800070	79332	39	800295	80129	66	800635	12313	55
800005	80000	18	800070	79333	39	800300	79269	66	800640	12314	55
800010	70953	18	800070	79343	39	800300	80130	66	800645	79575	74
800010	72616	18	800070	79393	39	800305	80133	73	800650	79576	74
800010	79073	18	800070	79542	39	800310	80134	73	800655	79567	74
800010	79205	18	800070	80022	39	800315	80135	73	800660	79568	74
800010	80001	18	800075	72267	68	800320	80136	73	800665	79375	74
800015	72062	18	800075	72274	68	800325	80150	64	800670	79376	74
800015	72234	18	800075	79004	68	800330	80163	18	800675	79359	31
800015	72593	18	800075	79630	68	800335	80164	19	800675	79713	31
800015	79726	18	800075	80023	68	800340	80165	19	800680	79360	31
800015	80008	18	800080	72254	70	800345	80166	19	800680	79714	31
800020	72063	18	800080	72269	70	800350	80167	19	800685	79163	42
800020	72235	18	800080	79023	70	800355	80168	19	800690	79162	42
800020	72594	18	800080	80024	70	800360	80176	21	800695	79472	74
800020	79725	18	800085	80025	71	800365	80177	21	800700	79473	74
800020	80009	18	800090	80030	18	800370	80178	21	800705	79166	42
800025	72037	18	800095	80031	18	800375	80179	22	800710	79165	42
800025	80010	18	800100	80032	52	800380	80180	22	800715	79464	31
800030	72036	18	800105	80033	71	800385	80181	22	800715	79724	31
800030	80011	18	800110	80034	71	800390	80183	22	800720	72019	57
800035	72040	18	800115	80035	71	800395	80191	53	800720	72198	57
800035	80012	18	800120	80037	52	800400	80192	53	800725	72179	49
800040	72041	18	800125	80039	56	800405	cs	46	800730	72777	53
800040	80013	18	800130	80040	56	800410	cs	51	800730	72779	53
800045	80014	18	800135	80041	39	800430	cs	44	800735	72114	67
800050	80018	38	800140	72853	72	800435	79052	39	800740	79161	31
800055	72253	44	800140	80042	72	800435	79338	39	800740	79428	31
800055	72263	44	800145	80045	72	800440	79053	39	800745	79657	55
800055	72271	44	800150	79416	46	800440	79339	39	800750	70871	25
800055	72703	44	800150	80061	46	800445	cs	30	800755	72117	26
800055	72763	44	800155	80067	72	800450	cs	30	800755	72530	26
800055	72875	44	800160	80069	72	800455	72468	23	800755	72535	26
800055	72876	44	800165	80070	72	800455	72893	23	800760	72182	45
800055	79327	44	800170	80071	72	800460	72469	23	800765	72558	26
800055	80019	44	800175	80072	72	800460	72892	23	800770	72778	53
800060	72258	64	800180	80073	72	800465	72688	70	800775	cs	26
800060	72581	64	800185	80074	72	800470	72689	70	800780	72309	26
800060	72788	64	800190	80075	72	800475	cs	73	800780	72327	26
800060	72883	64	800195	80076	72	800480	cs	73	800780	72541	26
800060	79183	64	800200	80077	72	800485	79137	19	800780	72547	26
800060	79235	64	800205	80078	73	800490	79136	19	800785	72540	26
800060	79284	64	800210	80082	73	800505	72854	70	800790	70864	23
800060	79324	64	800215	80084	21	800505	79242	70	800790	72662	23
800060	79459	64	800220	80086	21	800510	72855	70	800790	72963	23
800060	80020	64	800225	80087	21	800510	79241	70	800795	72030	44
800065	72266	51	800230	80088	21	800515	70572	30	800800	72827	39
800065	79022	51	800235	80089	73	800520	70571	30	800805	72862	65
800065	80021	51	800240	80092	21	800525	72450	60	800810	72837	66
800070	72250	39	800245	80093	21	800530	72451	60	800815	70801	24
800070	72261	39	800250	79267	39	800535	79065	70	800815	72947	24
800070	72265	39	800250	80094	39	800540	79066	70	800820	79353	74
800070	72270	39	800255	72768	73	800545	79587	73	800825	72820	74
800070	72702	39	800255	72858	73	800550	79588	73	800830	72016	40
800070	72863	39	800255	80095	73	800555	70527	57	800835	79390	75
800070	72948	39	800260	80106	69	800560	70526	57	800840	79079	63
800070	72999	39	800265	80107	69	800565	70583	57	800845	79648	62
800070	79005	39	800270	79649	65	800570	70582	57	800855	79661	55
800070	79006	39	800270	80108	65	800575	70652	57	800860	72585	69
800070	79035	39	800275	72333	68	800580	70651	57	800870	cs	22
800070	79109	39	800275	72425	68	800585	72105	57	800875	72348	22
800070	79112	39	800275	72667	68	800590	72106	57	800875	79202	22
800070	79149	39	800275	79564	68	800595	79097	64	800875	79215	22
800070	79160	39	800275	80109	68	800610	79098	64	800880	12310	55



* CS > Customer Specific / Özel İmalat

(SELF-SETTING) FULL AUTOMATIC PRODUCT TYPES ARE CONTINUOUSLY INCREASED.
PLEASE CONTACT WITH OUR MARKETING DEPARTMENT FOR FURTHER INFORMATIONS.
TAM OTOMATİK ÜRÜNLERİMİZ SÜREKLİ OLARAK ARTMAKTADIR. DETAYLI BİLGİ İÇİN
PAZARLAMA DEPARTMANI İLE İLETİŞİME GEÇİNİZ.

ALL ORIGINAL NUMBERS, MARKS AND MODELS FROM VEHICLE MANUFACTURERS
LISTED IN THIS CATALOGUE ARE FOR COMPARISON PURPOSES ONLY AND MAY NOT BE
USED IN INVOICES TO VEHICLE OWNERS OR RESELLERS / ORJINAL ÜRÜN NUMARALARI
MÜŞTERİYİ BİLGİLENDİRME VE ÜRÜNE REFERANS AMAÇLI KULLANILMIŞTIR.

AYS CODE - PART NUMBER

AYS CODE	PART NUMBER	PAGE NO	AYS CODE	PART NUMBER	PAGE NO	AYS CODE	PART NUMBER	PAGE NO	AYS CODE	PART NUMBER	PAGE NO
800885	12132	49	801210	79068	29	801490	79301	35	801700	72812	19
800885	72180	49	801215	79069	29	801495	72739	35	801700	79220	19
800885	72199	49	801220	70705	31	801495	79287	35	801700	79229	19
800890	79184	49	801220	79698	31	801495	79302	35	801705	72455	19
800895	72181	49	801225	79697	31	801500	79256	35	801705	72731	19
800895	72864	49	801230	72821	77	801500	79535	35	801705	72809	19
800900	79177	62	801235	72707	77	801505	79257	35	801705	72811	19
800905	79461	49	801240	79455	55	801505	79536	35	801705	79219	19
800910	79682	49	801245	79456	55	801510	72162	35	801705	79228	19
800915	79080	64	801250	79601	50	801510	79015	35	801710	70991	19
800920	72712	75	801255	79602	50	801515	72163	35	801715	70990	20
800925	70668	24	801260	79528	77	801515	79016	35	801720	70753	20
800925	72657	24	801265	79529	77	801520	72160	35	801720	72320	20
800930	70669	24	801270	79639	29	801520	79013	35	801720	79210	20
800930	72658	24	801275	79640	29	801520	79020	35	801725	70754	20
800935	72344	75	801280	72833	26	801525	72161	35	801725	72321	20
800940	72345	75	801285	72834	26	801525	79014	35	801725	79211	20
800945	79447	75	801290	79249	24	801525	79021	35	801730	cs	78
800950	79448	75	801295	79248	77	801530	79312	35	801735	70805	20
800955	79138	66	801300	79144	66	801535	79313	36	801735	70867	20
800960	79139	66	801305	79145	67	801540	72005	36	801735	72322	20
800965	72751	66	801310	70768	43	801540	79007	36	801735	79212	20
800970	72752	66	801310	79030	43	801545	72006	36	801740	70954	20
800975	72869	66	801315	79031	44	801545	79008	36	801740	72046	20
800980	72870	66	801315	79055	44	801550	72089	36	801745	72521	29
800985	72818	75	801320	79190	31	801550	79009	36	801750	72522	29
800990	72819	75	801320	79641	31	801555	72090	36	801755	72312	26
800995	11031	75	801325	79191	31	801555	79010	36	801755	72544	26
800995	79434	75	801325	79642	31	801560	70706	19	801755	72695	26
801000	11032	75	801330	72884	44	801570	72213	19	801760	72313	27
801000	79435	75	801335	72885	44	801575	cs	77	801760	72545	27
801005	79674	52	801340	70969	39	801580	79179	26	801760	72696	27
801010	79675	52	801340	72945	39	801585	79180	26	801765	70930	60
801015	10283	75	801345	70970	39	801590	72302	26	801770	70931	60
801020	10284	75	801345	72946	39	801590	72538	26	801775	79231	78
801025	79422	76	801350	72618	62	801595	72301	26	801780	79232	78
801030	79423	76	801355	72619	62	801595	72539	26	801785	79107	63
801035	72137	34	801360	72646	42	801600	79637	70	801790	79108	63
801040	72138	35	801365	72647	42	801605	79638	71	801795	70918	20
801070	79659	55	801370	79188	77	801610	79499	69	801800	70917	20
801075	79660	56	801375	79189	77	801615	79500	69	801805	72303	23
801080	72583	69	801380	72930	70	801620	79530	77	801805	79208	23
801085	72584	69	801380	79463	70	801625	79531	78	801805	79514	23
801090	79412	76	801385	79172	70	801630	72508	22	801810	72304	23
801090	79414	76	801390	72216	54	801630	79223	22	801810	79209	23
801095	79413	76	801395	72215	54	801635	72509	22	801810	79515	23
801095	79415	76	801400	72444	54	801635	79224	22	801815	72528	27
801100	72856	46	801400	72802	54	801640	72995	24	801815	cs	27
801105	72857	47	801405	72445	54	801640	79550	24	801820	72527	27
801110	79480	76	801405	72803	54	801645	72996	24	801825	12170	20
801115	79481	76	801410	79491	61	801645	79551	24	801825	72069	20
801120	79622	69	801415	79492	61	801650	72851	24	801825	72173	20
801125	79623	70	801420	72446	54	801650	79442	24	801825	72919	20
801130	79558	76	801425	72447	54	801650	79786	24	801825	72937	20
801135	79559	76	801430	79345	63	801655	72852	24	801825	79002	20
801140	79377	76	801435	79344	63	801655	79443	24	801825	79099	20
801145	79378	76	801440	12243	77	801655	79787	24	801830	12171	20
801150	72867	59	801445	12244	77	801660	79245	68	801830	72070	20
801155	72868	59	801450	79520	61	801665	79246	68	801830	72174	20
801160	79262	76	801455	79521	61	801670	79635	68	801830	72920	20
801165	79263	76	801460	79126	63	801675	79636	68	801830	72938	20
801170	72566	59	801465	79127	63	801680	cs	24	801830	79003	20
801175	72567	59	801470	70621	35	801685	cs	24	801830	79100	20
801180	70928	46	801475	70622	35	801690	cs	78	801835	79128	56
801185	70926	46	801480	79650	56	801695	cs	78	801835	cs	56
801190	70927	46	801485	79651	56	801700	72456	19	801840	72177	62
801200	79170	47	801490	72738	35	801700	72732	19	801845	70870	20
801205	79171	47	801490	79286	35	801700	72810	19	801850	70775	20

AYS CODE - PART NUMBER

AYS CODE	PART NUMBER	PAGE NO	AYS CODE	PART NUMBER	PAGE NO	AYS CODE	PART NUMBER	PAGE NO	AYS CODE	PART NUMBER	PAGE NO
801855	70878	24	802045	10938	47	802285	79044	39	802520	72153	32
801855	72660	24	802050	72107	27	802285	79337	39	802520	72783	32
801855	72949	24	802050	72523	27	802290	79599	43	802525	72152	32
801860	70879	24	802050	72525	27	802295	79600	43	802525	72782	32
801860	72661	24	802050	72586	27	802300	70802	39	802530	cs	79
801860	72950	24	802055	72108	27	802305	70803	39	802535	cs	79
801865	79275	31	802055	72524	27	802310	79028	68	802540	72060	20
801865	79677	31	802055	72526	27	802315	79029	68	802545	72061	21
801870	79276	31	802055	72587	27	802320	70641	32	802550	cs	80
801870	79678	31	802060	70893	47	802325	70642	32	802555	cs	80
801875	cs	25	802060	72147	47	802330	79493	61	802560	cs	80
801880	cs	25	802065	70894	47	802335	79494	61	802565	79562	80
801885	79349	50	802065	72148	47	802340	12254	53	802570	72872	71
801890	79350	50	802070	70649	31	802345	12255	53	802575	72059	21
801895	72621	25	802070	72912	31	802350	72591	40	802575	72596	21
801895	72664	25	802075	70648	31	802355	72592	40	802575	79185	21
801895	72665	25	802080	72815	27	802360	79537	79	802580	72056	21
801900	72620	25	802085	72816	27	802365	79538	79	802585	79608	23
801900	72663	25	802090	10868	27	802370	72014	40	802590	72224	28
801900	72666	25	802090	70824	27	802375	72015	40	802590	72537	28
801905	70938	25	802095	10869	27	802380	70718	40	802590	72680	28
801910	70937	25	802095	70825	27	802385	70719	41	802595	72223	28
801915	79394	29	802100	12141	51	802390	72370	41	802595	72536	28
801920	79395	29	802100	72917	51	802395	72371	41	802595	72679	28
801925	12363	53	802105	12142	51	802400	72368	41	802600	70832	33
801930	12364	53	802105	72918	51	802400	79040	41	802605	70833	33
801935	79407	29	802120	70987	57	802400	79236	41	802610	70922	33
801940	79408	30	802125	70988	57	802405	72369	41	802610	72669	33
801945	79404	78	802130	70647	32	802405	79041	41	802615	70921	33
801950	79405	78	802130	72806	32	802405	79237	41	802615	72668	33
801955	79310	36	802135	70646	32	802410	79510	69	802620	70924	33
801960	79311	36	802135	72805	32	802415	79511	69	802620	72671	33
801965	79308	36	802140	70977	32	802420	79465	37	802625	70923	33
801970	79309	36	802145	70978	32	802420	79683	37	802625	72670	33
801975	79476	36	802150	12116	78	802425	79466	37	802630	cs	33
801975	79478	36	802155	12117	78	802425	79684	37	802635	79372	30
801980	79477	36	802160	79158	52	802430	72835	37	802640	72311	28
801980	79479	36	802165	79159	52	802430	79299	37	802640	72543	28
801985	72993	36	802170	79258	56	802435	72836	37	802645	72310	28
801985	79294	36	802175	79259	56	802435	79300	37	802645	72542	28
801985	79296	36	802180	10274	47	802440	72634	37	802650	79471	80
801985	79440	36	802180	72417	47	802440	79000	37	802655	79470	80
801990	72994	37	802180	79156	47	802440	79018	37	802660	70663	25
801990	79295	37	802185	10275	48	802440	79306	37	802660	72745	25
801990	79297	37	802185	72418	48	802445	72633	37	802665	70662	25
801990	79441	37	802185	79157	48	802445	79001	37	802665	72744	25
801995	70897	37	802190	72150	27	802445	79017	37	802670	72017	41
801995	79474	37	802195	72151	27	802445	79307	37	802675	72018	41
801995	79561	37	802200	72532	27	802450	72431	68	802680	72761	46
802000	70896	37	802205	72533	28	802455	72430	69	802685	72762	46
802000	79475	37	802210	70840	57	802460	72741	38	802690	79613	71
802000	79560	37	802210	72140	57	802460	79289	38	802695	79614	71
802005	72786	37	802215	70841	58	802460	79304	38	802700	79691	80
802005	79290	37	802215	72141	58	802465	72740	38	802705	79692	80
802005	79292	37	802220	72904	32	802465	79288	38	802710	79233	80
802005	79581	37	802220	72914	32	802465	79305	38	802720	12182	50
802005	79628	37	802225	70782	32	802470	72372	41	802725	70809	49
802010	72787	37	802230	79483	79	802475	72373	41	802725	70810	49
802010	79291	37	802235	79484	79	802480	12112	68	802730	70891	49
802010	79293	37	802240	10714	45	802485	12113	68	802735	79363	46
802010	79582	37	802245	10715	45	802490	70910	32	802740	72419	45
802010	79629	37	802250	70511	58	802490	72724	32	802745	70919	45
802015	70899	37	802255	70512	58	802495	70909	32	802750	72575	47
802020	72206	56	802260	79142	67	802495	72723	32	802755	72189	47
802025	72207	56	802265	79143	67	802500	cs	79	802760	72085	33
802030	79589	78	802270	79495	79	802505	cs	79	802765	72190	47
802035	79590	78	802275	79496	79	802510	cs	79	802770	70510	58
802040	10937	47	802280	79043	39	802515	cs	79	802775	72406	58



* CS > Customer Specific / Özel İmalat

(SELF-SETTING) FULL AUTOMATIC PRODUCT TYPES ARE CONTINUOUSLY INCREASED.
PLEASE CONTACT WITH OUR MARKETING DEPARTMENT FOR FURTHER INFORMATIONS.
TAM OTOMATİK ÜRÜNLERİMİZ SÜREKLİ OLARAK ARTMAKTADIR. DETAYLI BİLGİ İÇİN
PAZARLAMA DEPARTMANI İLE İLETİŞİME GEÇİNİZ.

ALL ORIGINAL NUMBERS, MARKS AND MODELS FROM VEHICLE MANUFACTURERS
LISTED IN THIS CATALOGUE ARE FOR COMPARISON PURPOSES ONLY AND MAY NOT BE
USED IN INVOICES TO VEHICLE OWNERS OR RESELLERS / ORJINAL ÜRÜN NUMARALARI
MÜŞTERİYİ BİLGİLENDİRME VE ÜRÜNE REFERANS AMAÇLI KULLANILMIŞTIR.

AYS CODE - PART NUMBER

AYS CODE	PART NUMBER	PAGE NO	AYS CODE	PART NUMBER	PAGE NO	AYS CODE	PART NUMBER	PAGE NO	AYS CODE	PART NUMBER	PAGE NO
802780	72195	58	802995	72126	34	803245	79427	82	803505	79092	59
802780	72405	58	802995	72944	34	803250	72896	68	803510	79274	84
802785	72361	60	803000	70905	42	803255	70726	55	803515	72824	38
802790	10939	48	803005	70788	81	803260	79230	82	803515	79298	38
802795	72454	80	803010	10912	81	803270	70720	41	803520	79082	60
802800	12360	80	803015	70703	34	803275	72385	71	803525	79268	64
802805	79617	48	803015	70957	34	803280	12256	53	803530	72601	38
802810	79370	80	803015	72903	34	803280	72697	53	803535	72599	38
802815	79569	81	803020	12196	81	803285	72356	67	803540	72600	38
802820	79618	48	803025	72329	52	803290	72326	28	803545	70687	41
802825	10911	81	803025	79696	52	803290	72330	28	803545	70989	41
802830	72364	48	803025	79735	52	803290	72641	28	803550	70979	51
802835	79646	48	803030	79658	56	803290	79371	28	803555	70854	51
802840	70740	33	803035	70903	45	803295	72750	54	803560	70959	51
802840	72145	33	803040	70660	58	803295	72828	54	803565	72154	59
802840	72362	33	803045	72144	47	803300	72315	38	803570	70892	49
802840	72725	33	803045	72568	47	803300	72804	38	803575	79111	46
802840	72905	33	803045	79071	47	803305	72214	62	803580	72871	43
802845	72246	33	803050	79458	81	803310	72709	54	803585	72733	52
802845	79271	33	803055	70650	58	803315	70762	67	803585	cs	52
802850	72011	33	803060	79285	82	803315	70764	67	803590	72569	51
802855	72009	25	803065	79501	30	803320	72408	49	803595	79620	84
802855	72910	25	803070	72464	34	803320	72831	49	803600	79148	67
802860	79449	81	803070	72654	34	803325	79532	83	803605	79091	61
802865	79450	81	803070	79178	34	803330	79121	63	803610	79114	61
802870	72735	81	803075	70661	25	803345	72928	63	803615	79067	64
802875	79517	81	803075	72962	25	803350	79056	63	803630	79563	84
802880	72166	33	803080	70598	34	803355	cs	83	803635	72359	65
802880	72678	33	803080	72909	34	803365	79454	55	803640	79051	65
802890	70851	30	803080	72913	34	803370	79103	62	803645	79643	30
802895	72407	58	803085	72553	28	803375	79482	83	803650	72260	30
802900	70986	44	803090	70530	58	803380	79192	62	803650	72262	30
802900	72149	44	803095	70634	59	803385	79541	83	803655	72256	51
802900	72643	44	803100	70945	59	803385	79543	83	803655	72268	51
802900	72644	44	803100	72563	59	803390	79595	83	803660	72255	65
802905	70573	48	803105	12307	45	803395	79545	83	803670	79552	43
802905	70859	48	803105	70678	45	803400	79626	70	803670	79619	43
802905	72457	48	803110	70752	82	803405	79255	83	803675	72645	40
802910	79062	48	803120	72143	61	803410	79652	62	803685	79346	40
802915	70823	28	803125	70886	64	803415	72438	23	803690	cs	84
802915	70946	28	803130	79424	82	803415	79218	23	803695	cs	45
802915	72363	28	803135	79685	48	803420	72529	29	803705	12356	55
802915	72367	28	803140	79277	82	803425	72208	23	803710	72614	63
802915	72393	28	803145	72031	51	803425	72578	23	803710	72888	63
802915	72677	28	803145	72115	51	803425	72865	23	803715	cs	84
802915	79169	28	803150	72103	51	803425	79132	23	803720	72582	84
802920	72197	28	803155	72334	40	803425	79193	23	803725	72251	67
802920	72534	28	803160	79457	82	803425	79207	23	803730	72642	38
802920	72550	28	803165	70576	51	803425	79227	23	803735	72939	50
802925	11011	28	803170	70882	64	803425	79695	23	803740	79133	50
802930	72314	28	803170	70887	64	803430	cs	23	803750	72281	84
802930	72531	28	803175	70532	59	803435	72205	56	803755	72861	84
802930	72546	28	803180	79444	46	803440	72964	83	803760	72104	52
802935	72428	30	803185	72249	25	803445	70932	34	803765	72259	65
802935	72429	30	803185	79090	25	803450	79061	83	803770	72273	84
802940	72517	34	803190	72554	40	803455	72100	38	803775	72252	42
802945	79361	81	803195	70787	59	803455	79012	38	803775	72416	42
802955	cs	71	803195	72086	59	803455	79019	38	803775	72758	42
802960	cs	28	803200	72448	45	803460	72099	38	803780	72272	85
802965	cs	81	803205	70804	67	803460	79011	38	803785	72789	85
802970	72570	34	803210	72053	40	803465	10519	42	803790	79247	85
802975	72817	55	803210	72710	40	803470	72840	38	803795	72157	63
802980	72167	34	803220	79354	82	803470	79303	38	803800	cs	46
802980	72726	34	803225	79437	82	803475	72699	83	803810	80200	85
802985	72588	58	803230	79460	82	803480	12320	84	803840	80333	85
802990	70941	34	803235	79436	82	803485	79548	43	803850	cs	85
802990	72676	34	803240	79533	82	803495	72769	84			
802990	72908	34	803245	72698	82	803500	72376	41			

PART NUMBER - AYS CODE

PART NUMBER	AYS CODE	PAGE NO	PART NUMBER	AYS CODE	PAGE NO	PART NUMBER	AYS CODE	PAGE NO	PART NUMBER	AYS CODE	PAGE NO
10274	802180	47	70660	803040	58	70923	802625	33	72114	800735	67
10275	802185	48	70661	803075	25	70924	802620	33	72115	803145	51
10283	801015	75	70662	802665	25	70926	801185	46	72117	800755	26
10284	801020	75	70663	802660	25	70927	801190	46	72126	802995	34
10519	803465	42	70668	800925	24	70928	801180	46	72137	801035	34
10714	802240	45	70669	800930	24	70930	801765	60	72138	801040	35
10715	802245	45	70678	803105	45	70931	801770	60	72140	802210	57
10868	802090	27	70687	803545	41	70932	803445	34	72141	802215	58
10869	802095	27	70703	803015	34	70937	801910	25	72143	803120	61
10911	802825	81	70705	801220	31	70938	801905	25	72144	803045	47
10912	803010	81	70706	801560	19	70941	802990	34	72145	802840	33
10937	802040	47	70718	802380	40	70945	803100	59	72147	802060	47
10938	802045	47	70719	802385	41	70946	802915	28	72148	802065	47
10939	802790	48	70720	803270	41	70952	800005	18	72149	802900	44
11011	802925	28	70726	803255	55	70953	800010	18	72150	802190	27
11031	800995	75	70740	802840	33	70954	801740	20	72151	802195	27
11032	801000	75	70752	803110	82	70957	803015	34	72152	802525	32
12112	802480	68	70753	801720	20	70959	803560	51	72153	802520	32
12113	802485	68	70754	801725	20	70969	801340	39	72154	803565	59
12116	802150	78	70762	803315	67	70970	801345	39	72157	803795	63
12117	802155	78	70764	803315	67	70977	802140	32	72160	801520	35
12132	800885	49	70768	801310	43	70978	802145	32	72161	801525	35
12141	802100	51	70775	801850	20	70979	803550	51	72162	801510	35
12142	802105	51	70782	802225	32	70986	802900	44	72163	801515	35
12170	801825	20	70787	803195	59	70987	802120	57	72166	802880	33
12171	801830	20	70788	803005	81	70988	802125	57	72167	802980	34
12182	802720	50	70801	800815	24	70989	803545	41	72173	801825	20
12196	803020	81	70802	802300	39	70990	801715	20	72174	801830	20
12243	801440	77	70803	802305	39	70991	801710	19	72177	801840	62
12244	801445	77	70804	803205	67	72005	801540	36	72179	800725	49
12254	802340	53	70805	801735	20	72006	801545	36	72180	800885	49
12255	802345	53	70809	802725	49	72009	802855	25	72181	800895	49
12256	803280	53	70810	802725	49	72011	802850	33	72182	800760	45
12307	803105	45	70823	802915	28	72013	800005	18	72189	802755	47
12310	800880	55	70824	802090	27	72014	802370	40	72190	802765	47
12313	800635	55	70825	802095	27	72015	802375	40	72195	802780	58
12314	800640	55	70832	802600	33	72016	800830	40	72197	802920	28
12320	803480	84	70833	802605	33	72017	802670	41	72198	800720	57
12356	803705	55	70840	802210	57	72018	802675	41	72199	800885	49
12360	802800	80	70841	802215	58	72019	800720	57	72205	803435	56
12363	801925	53	70851	802890	30	72030	800795	44	72206	802020	56
12364	801930	53	70854	803555	51	72031	803145	51	72207	802025	56
70510	802770	58	70859	802905	48	72036	800030	18	72208	803425	23
70511	802250	58	70864	800790	23	72037	800025	18	72213	801570	19
70512	802255	58	70867	801735	20	72040	800035	18	72214	803305	62
70526	800560	57	70870	801845	20	72041	800040	18	72215	801395	54
70527	800555	57	70871	800750	25	72046	801740	20	72216	801390	54
70530	803090	58	70878	801855	24	72053	803210	40	72223	802595	28
70532	803175	59	70879	801860	24	72056	802580	21	72224	802590	28
70571	800520	30	70882	803170	64	72059	802575	21	72234	800015	18
70572	800515	30	70886	803125	64	72060	802540	20	72235	800020	18
70573	802905	48	70887	803170	64	72061	802545	21	72246	802845	33
70576	803165	51	70891	802730	49	72062	800015	18	72249	803185	25
70582	800570	57	70892	803570	49	72063	800020	18	72250	800070	39
70583	800565	57	70893	802060	47	72069	801825	20	72251	803725	67
70598	803080	34	70894	802065	47	72070	801830	20	72252	803775	42
70621	801470	35	70896	802000	37	72085	802760	33	72253	800055	44
70622	801475	35	70897	801995	37	72086	803195	59	72254	800080	70
70634	803095	59	70899	802015	37	72089	801550	36	72255	803660	65
70641	802320	32	70903	803035	45	72090	801555	36	72256	803655	51
70642	802325	32	70905	803000	42	72099	803460	38	72258	800060	64
70646	802135	32	70909	802495	32	72100	803455	38	72259	803765	65
70647	802130	32	70910	802490	32	72103	803150	51	72260	803650	30
70648	802075	31	70917	801800	20	72104	803760	52	72261	800070	39
70649	802070	31	70918	801795	20	72105	800585	57	72262	803650	30
70650	803055	58	70919	802745	45	72106	800590	57	72263	800055	44
70651	800580	57	70921	802615	33	72107	802050	27	72265	800070	39
70652	800575	57	70922	802610	33	72108	802055	27	72266	800065	51



* CS > Customer Specific / Özel İmalat

(SELF-SETTING) FULL AUTOMATIC PRODUCT TYPES ARE CONTINUOUSLY INCREASED.
PLEASE CONTACT WITH OUR MARKETING DEPARTMENT FOR FURTHER INFORMATIONS.
TAM OTOMATİK ÜRÜNLERİMİZ SÜREKLİ OLARAK ARTMAKTADIR. DETAYLI BİLGİ İÇİN
PAZARLAMA DEPARTMANI İLE İLETİŞİME GEÇİNİZ.

ALL ORIGINAL NUMBERS, MARKS AND MODELS FROM VEHICLE MANUFACTURERS
LISTED IN THIS CATALOGUE ARE FOR COMPARISON PURPOSES ONLY AND MAY NOT BE
USED IN INVOICES TO VEHICLE OWNERS OR RESELLERS / ORJINAL ÜRÜN NUMARALARI
MÜŞTERİYİ BİLGİLENDİRME VE ÜRÜNE REFERANS AMAÇLI KULLANILMIŞTIR.

PART NUMBER - AYS CODE

PART NUMBER	AYS CODE	PAGE NO	PART NUMBER	AYS CODE	PAGE NO	PART NUMBER	AYS CODE	PAGE NO	PART NUMBER	AYS CODE	PAGE NO
72267	800075	68	72451	800530	60	72617	800005	18	72768	800255	73
72268	803655	51	72454	802795	80	72618	801350	62	72769	803495	84
72269	800080	70	72455	801705	19	72619	801355	62	72777	800730	53
72270	800070	39	72456	801700	19	72620	801900	25	72778	800770	53
72271	800055	44	72457	802905	48	72621	801895	25	72779	800730	53
72272	803780	85	72464	803070	34	72633	802445	37	72782	802525	32
72273	803770	84	72468	800455	23	72634	802440	37	72783	802520	32
72274	800075	68	72469	800460	23	72641	803290	28	72786	802005	37
72281	803750	84	72508	801630	22	72642	803730	38	72787	802010	37
72301	801595	26	72509	801635	22	72643	802900	44	72788	800060	64
72302	801590	26	72517	802940	34	72644	802900	44	72789	803785	85
72303	801805	23	72521	801745	29	72645	803675	40	72802	801400	54
72304	801810	23	72522	801750	29	72646	801360	42	72803	801405	54
72309	800780	26	72523	802050	27	72647	801365	42	72804	803300	38
72310	802645	28	72524	802055	27	72654	803070	34	72805	802135	32
72311	802640	28	72525	802050	27	72657	800925	24	72806	802130	32
72312	801755	26	72526	802055	27	72658	800930	24	72809	801705	19
72313	801760	27	72527	801820	27	72660	801855	24	72810	801700	19
72314	802930	28	72528	801815	27	72661	801860	24	72811	801705	19
72315	803300	38	72529	803420	29	72662	800790	23	72812	801700	19
72320	801720	20	72530	800755	26	72663	801900	25	72815	802080	27
72321	801725	20	72531	802930	28	72664	801895	25	72816	802085	27
72322	801735	20	72532	802200	27	72665	801895	25	72817	802975	55
72326	803290	28	72533	802205	28	72666	801900	25	72818	800985	75
72327	800780	26	72534	802920	28	72667	800275	68	72819	800990	75
72329	803025	52	72535	800755	26	72668	802615	33	72820	800825	74
72330	803290	28	72536	802595	28	72669	802610	33	72821	801230	77
72333	800275	68	72537	802590	28	72670	802625	33	72824	803515	38
72334	803155	40	72538	801590	26	72671	802620	33	72827	800800	39
72344	800935	75	72539	801595	26	72676	802990	34	72828	803295	54
72345	800940	75	72540	800785	26	72677	802915	28	72831	803320	49
72348	800875	22	72541	800780	26	72678	802880	33	72833	801280	26
72356	803285	67	72542	802645	28	72679	802595	28	72834	801285	26
72359	803635	65	72543	802640	28	72680	802590	28	72835	802430	37
72361	802785	60	72544	801755	26	72688	800465	70	72836	802435	37
72362	802840	33	72545	801760	27	72689	800470	70	72837	800810	66
72363	802915	28	72546	802930	28	72695	801755	26	72840	803470	38
72364	802830	48	72547	800780	26	72696	801760	27	72851	801650	24
72367	802915	28	72550	802920	28	72697	803280	53	72852	801655	24
72368	802400	41	72553	803085	28	72698	803245	82	72853	800140	72
72369	802405	41	72554	803190	40	72699	803475	83	72854	800505	70
72370	802390	41	72558	800765	26	72702	800070	39	72855	800510	70
72371	802395	41	72563	803100	59	72703	800055	44	72856	801100	46
72372	802470	41	72566	801170	59	72707	801235	77	72857	801105	47
72373	802475	41	72567	801175	59	72709	803310	54	72858	800255	73
72376	803500	41	72568	803045	47	72710	803210	40	72861	803755	84
72385	803275	71	72569	803590	51	72712	800920	75	72862	800805	65
72393	802915	28	72570	802970	34	72723	802495	32	72863	800070	39
72405	802780	58	72575	802750	47	72724	802490	32	72864	800895	49
72406	802775	58	72578	803425	23	72725	802840	33	72865	803425	23
72407	802895	58	72581	800060	64	72726	802980	34	72867	801150	59
72408	803320	49	72582	803720	84	72731	801705	19	72868	801155	59
72416	803775	42	72583	801080	69	72732	801700	19	72869	800975	66
72417	802180	47	72584	801085	69	72733	803585	52	72870	800980	66
72418	802185	48	72585	800860	69	72735	802870	81	72871	803580	43
72419	802740	45	72586	802050	27	72738	801490	35	72872	802570	71
72425	800275	68	72587	802055	27	72739	801495	35	72875	800055	44
72428	802935	30	72588	802985	58	72740	802465	38	72876	800055	44
72429	802935	30	72591	802350	40	72741	802460	38	72883	800060	64
72430	802455	69	72592	802355	40	72744	802665	25	72884	801330	44
72431	802450	68	72593	800015	18	72745	802660	25	72885	801335	44
72438	803415	23	72594	800020	18	72750	803295	54	72888	803710	63
72444	801400	54	72596	802575	21	72751	800965	66	72892	800460	23
72445	801405	54	72599	803535	38	72752	800970	66	72893	800455	23
72446	801420	54	72600	803540	38	72758	803775	42	72896	803250	68
72447	801425	54	72601	803530	38	72761	802680	46	72903	803015	34
72448	803200	45	72614	803710	63	72762	802685	46	72904	802220	32
72450	800525	60	72616	800010	18	72763	800055	44	72905	802840	33

PART NUMBER - AYS CODE

PART NUMBER	AYS CODE	PAGE NO	PART NUMBER	AYS CODE	PAGE NO	PART NUMBER	AYS CODE	PAGE NO	PART NUMBER	AYS CODE	PAGE NO
72908	802990	34	79061	803450	83	79190	801320	31	79297	801990	37
72909	803080	34	79062	802910	48	79191	801325	31	79298	803515	38
72910	802855	25	79065	800535	70	79192	803380	62	79299	802430	37
72912	802070	31	79066	800540	70	79193	803425	23	79300	802435	37
72913	803080	34	79067	803615	64	79202	800875	22	79301	801490	35
72914	802220	32	79068	801210	29	79205	800010	18	79302	801495	35
72917	802100	51	79069	801215	29	79206	800005	18	79303	803470	38
72918	802105	51	79071	803045	47	79207	803425	23	79304	802460	38
72919	801825	20	79073	800010	18	79208	801805	23	79305	802465	38
72920	801830	20	79074	800005	18	79209	801810	23	79306	802440	37
72928	803345	63	79079	800840	63	79210	801720	20	79307	802445	37
72930	801380	70	79080	800915	64	79211	801725	20	79308	801965	36
72937	801825	20	79082	803520	60	79212	801735	20	79309	801970	36
72938	801830	20	79090	803185	25	79215	800875	22	79310	801955	36
72939	803735	50	79091	803605	61	79218	803415	23	79311	801960	36
72944	802995	34	79092	803505	59	79219	801705	19	79312	801530	35
72945	801340	39	79094	800615	42	79220	801700	19	79313	801535	36
72946	801345	39	79095	800620	42	79223	801630	22	79324	800060	64
72947	800815	24	79097	800595	64	79224	801635	22	79326	800070	39
72948	800070	39	79098	800610	64	79227	803425	23	79327	800055	44
72949	801855	24	79099	801825	20	79228	801705	19	79330	800070	39
72950	801860	24	79100	801830	20	79229	801700	19	79331	800070	39
72962	803075	25	79103	803370	62	79230	803260	82	79332	800070	39
72963	800790	23	79107	801785	63	79231	801775	78	79333	800070	39
72964	803440	83	79108	801790	63	79232	801780	78	79337	802285	39
72993	801985	36	79109	800070	39	79233	802710	80	79338	800435	39
72994	801990	37	79111	803575	46	79235	800060	64	79339	800440	39
72995	801640	24	79112	800070	39	79236	802400	41	79343	800070	39
72996	801645	24	79114	803610	61	79237	802405	41	79344	801435	63
72999	800070	39	79121	803340	63	79238	800625	74	79345	801430	63
79000	802440	37	79126	801460	63	79239	800630	74	79346	803685	40
79001	802445	37	79127	801465	63	79240	800070	39	79349	801885	50
79002	801825	20	79128	801835	56	79241	800510	70	79350	801890	50
79003	801830	20	79132	803425	23	79242	800505	70	79353	800820	74
79004	800075	68	79133	803740	50	79245	801660	68	79354	803220	82
79005	800070	39	79136	800490	19	79246	801665	68	79359	800675	31
79006	800070	39	79137	800485	19	79247	803790	85	79360	800680	31
79007	801540	36	79138	800955	66	79248	801295	77	79361	802945	81
79008	801545	36	79139	800960	66	79249	801290	24	79363	802735	46
79009	801550	36	79142	802260	67	79255	803405	83	79370	802810	80
79010	801555	36	79143	802265	67	79256	801500	35	79371	803290	28
79011	803460	38	79144	801300	66	79257	801505	35	79372	802635	30
79012	803455	38	79145	801305	67	79258	802170	56	79375	800665	74
79013	801520	35	79148	803600	67	79259	802175	56	79376	800670	74
79014	801525	35	79149	800070	39	79262	801160	76	79377	801140	76
79015	801510	35	79156	802180	47	79263	801165	76	79378	801145	76
79016	801515	35	79157	802185	48	79267	800250	39	79390	800835	75
79017	802445	37	79158	802160	52	79268	803525	64	79393	800070	39
79018	802440	37	79159	802165	52	79269	800300	66	79394	801915	29
79019	803455	38	79160	800070	39	79270	800295	66	79395	801920	29
79020	801520	35	79161	800740	31	79271	802845	33	79404	801945	78
79021	801525	35	79162	800690	42	79274	803510	84	79405	801950	78
79022	800065	51	79163	800685	42	79275	801865	31	79407	801935	29
79023	800080	70	79165	800710	42	79276	801870	31	79408	801940	30
79028	802310	68	79166	800705	42	79277	803140	82	79412	801090	76
79029	802315	68	79169	802915	28	79284	800060	64	79413	801095	76
79030	801310	43	79170	801200	47	79285	803060	82	79414	801090	76
79031	801315	44	79171	801205	47	79286	801490	35	79415	801095	76
79035	800070	39	79172	801385	70	79287	801495	35	79416	800150	46
79040	802400	41	79177	800900	62	79288	802465	38	79422	801025	76
79041	802405	41	79178	803070	34	79289	802460	38	79423	801030	76
79043	802280	39	79179	801580	26	79290	802005	37	79424	803130	82
79044	802285	39	79180	801585	26	79291	802010	37	79427	803245	82
79051	803640	65	79183	800060	64	79292	802005	37	79428	800740	31
79052	800435	39	79184	800890	49	79293	802010	37	79434	800995	75
79053	800440	39	79185	802575	21	79294	801985	36	79435	801000	75
79055	801315	44	79188	801370	77	79295	801990	37	79436	803235	82
79056	803350	63	79189	801375	77	79296	801985	36	79437	803225	82



* CS > Customer Specific / Özel İmalat

(SELF-SETTING) FULL AUTOMATIC PRODUCT TYPES ARE CONTINUOUSLY INCREASED.
PLEASE CONTACT WITH OUR MARKETING DEPARTMENT FOR FURTHER INFORMATIONS.
TAM OTOMATİK ÜRÜNLERİMİZ SÜREKLİ OLARAK ARTMAKTADIR. DETAYLI BİLGİ İÇİN
PAZARLAMA DEPARTMANI İLE İLETİŞİME GEÇİNİZ.

ALL ORIGINAL NUMBERS, MARKS AND MODELS FROM VEHICLE MANUFACTURERS
LISTED IN THIS CATALOGUE ARE FOR COMPARISON PURPOSES ONLY AND MAY NOT BE
USED IN INVOICES TO VEHICLE OWNERS OR RESELLERS / ORJINAL ÜRÜN NUMARALARI
MÜŞTERİYİ BİLGİLENDİRME VE ÜRÜNE REFERANS AMAÇLI KULLANILMIŞTIR.

PART NUMBER - AYS CODE

PART NUMBER	AYS CODE	PAGE NO	PART NUMBER	AYS CODE	PAGE NO	PART NUMBER	AYS CODE	PAGE NO	PART NUMBER	AYS CODE	PAGE NO
79440	801985	36	79551	801645	24	79695	803425	23	80125	800285	66
79441	801990	37	79552	803670	43	79696	803025	52	80126	800290	66
79442	801650	24	79558	801130	76	79697	801225	31	80129	800295	66
79443	801655	24	79559	801135	76	79698	801220	31	80130	800300	66
79444	803180	46	79560	802000	37	79713	800675	31	80133	800305	73
79447	800945	75	79561	801995	37	79714	800680	31	80134	800310	73
79448	800950	75	79562	802565	80	79724	800715	31	80135	800315	73
79449	802860	81	79563	803630	84	79725	800020	18	80136	800320	73
79450	802865	81	79564	800275	68	79726	800015	18	80150	800325	64
79454	803365	55	79567	800655	74	79735	803025	52	80163	800330	18
79455	801240	55	79568	800660	74	79786	801650	24	80164	800335	19
79456	801245	55	79569	802815	81	79787	801655	24	80165	800340	19
79457	803160	82	79575	800645	74	80000	800005	18	80166	800345	19
79458	803050	81	79576	800650	74	80001	800010	18	80167	800350	19
79459	800060	64	79581	802005	37	80008	800015	18	80168	800355	19
79460	803230	82	79582	802010	37	80009	800020	18	80176	800360	21
79461	800905	49	79587	800545	73	80010	800025	18	80177	800365	21
79463	801380	70	79588	800550	73	80011	800030	18	80178	800370	21
79464	800715	31	79589	802030	78	80012	800035	18	80179	800375	22
79465	802420	37	79590	802035	78	80013	800040	18	80180	800380	22
79466	802425	37	79595	803390	83	80014	800045	18	80181	800385	22
79470	802655	80	79599	802290	43	80018	800050	38	80183	800390	22
79471	802650	80	79600	802295	43	80019	800055	44	80191	800395	53
79472	800695	74	79601	801250	50	80020	800060	64	80192	800400	53
79473	800700	74	79602	801255	50	80021	800065	51	80200	803810	85
79474	801995	37	79608	802585	23	80022	800070	39	80333	803840	85
79475	802000	37	79613	802690	71	80023	800075	68	cs	800405	46
79476	801975	36	79614	802695	71	80024	800080	70	cs	800410	51
79477	801980	36	79617	802805	48	80025	800085	71	cs	800430	44
79478	801975	36	79618	802820	48	80030	800090	18	cs	800445	30
79479	801980	36	79619	803670	43	80031	800095	18	cs	800450	30
79480	801110	76	79620	803595	84	80032	800100	52	cs	800475	73
79481	801115	76	79622	801120	69	80033	800105	71	cs	800480	73
79482	803375	83	79623	801125	70	80034	800110	71	cs	800775	26
79483	802230	79	79626	803400	70	80035	800115	71	cs	800870	22
79484	802235	79	79628	802005	37	80037	800120	52	cs	801575	77
79491	801410	61	79629	802010	37	80039	800125	56	cs	801680	24
79492	801415	61	79630	800075	68	80040	800130	56	cs	801685	24
79493	802330	61	79635	801670	68	80041	800135	39	cs	801690	78
79494	802335	61	79636	801675	68	80042	800140	72	cs	801695	78
79495	802270	79	79637	801600	70	80045	800145	72	cs	801730	78
79496	802275	79	79638	801605	71	80061	800150	46	cs	801815	27
79499	801610	69	79639	801270	29	80067	800155	72	cs	801835	56
79500	801615	69	79640	801275	29	80069	800160	72	cs	801875	25
79501	803065	30	79641	801320	31	80070	800165	72	cs	801880	25
79510	802410	69	79642	801325	31	80071	800170	72	cs	802500	79
79511	802415	69	79643	803645	30	80072	800175	72	cs	802505	79
79514	801805	23	79646	802835	48	80073	800180	72	cs	802510	79
79515	801810	23	79648	800845	62	80074	800185	72	cs	802515	79
79517	802875	81	79649	800270	65	80075	800190	72	cs	802530	79
79520	801450	61	79650	801480	56	80076	800195	72	cs	802535	79
79521	801455	61	79651	801485	56	80077	800200	72	cs	802550	80
79528	801260	77	79652	803410	62	80078	800205	73	cs	802555	80
79529	801265	77	79657	800745	55	80082	800210	73	cs	802560	80
79530	801620	77	79658	803030	56	80084	800215	21	cs	802630	33
79531	801625	78	79659	801070	55	80086	800220	21	cs	802955	71
79532	803325	83	79660	801075	56	80087	800225	21	cs	802960	28
79533	803240	82	79661	800855	55	80088	800230	21	cs	802965	81
79535	801500	35	79674	801005	52	80089	800235	73	cs	803355	83
79536	801505	35	79675	801010	52	80092	800240	21	cs	803430	23
79537	802360	79	79677	801865	31	80093	800245	21	cs	803585	52
79538	802365	79	79678	801870	31	80094	800250	39	cs	803690	84
79541	803385	83	79682	800910	49	80095	800255	73	cs	803695	45
79542	800070	39	79683	802420	37	80106	800260	69	cs	803715	84
79543	803385	83	79684	802425	37	80107	800265	69	cs	803800	46
79545	803395	83	79685	803135	48	80108	800270	65	cs	803850	85
79548	803485	43	79691	802700	80	80109	800275	68			
79550	801640	24	79692	802705	80	80124	800280	65			

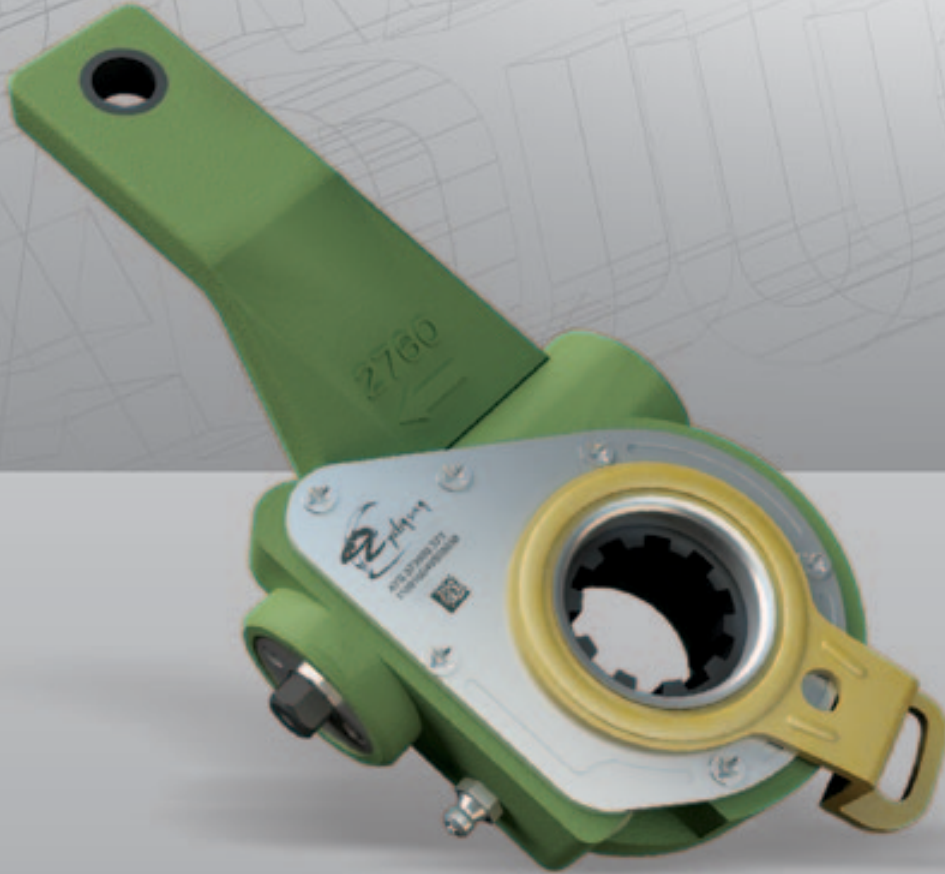

Utility Number:
Faydalı Model No:
2008/08662

Automatic Brake Adjuster

Otomatik Fren Ayar Kolları



UTILITY

FAYDALI MODEL

Utility Number:
Faydalı Model No:
2008/08662

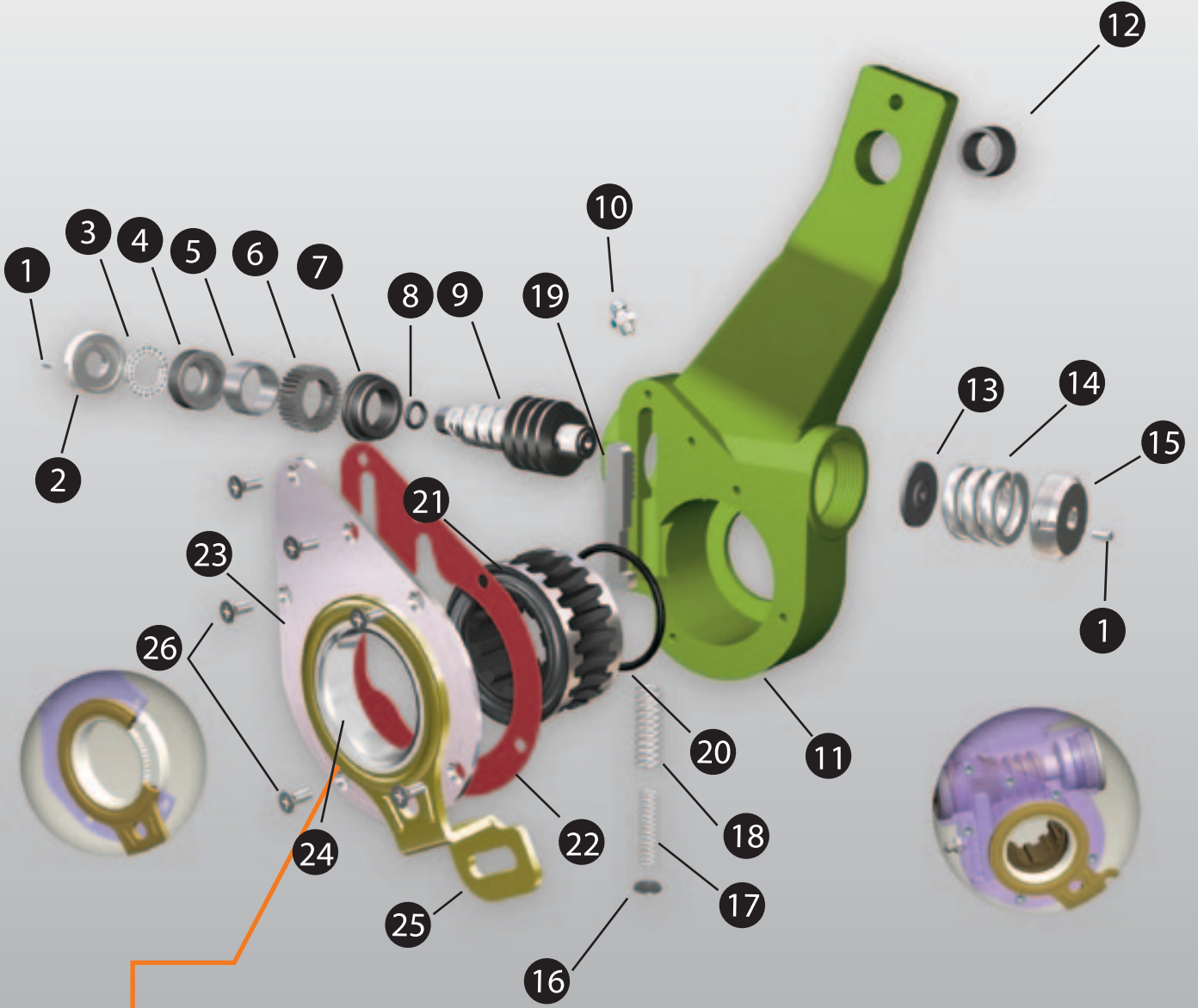

**Termination cases of
untightened control unit**
with improved control unit system

Geliştirilmiş kapak sistemi ile
kapak kaçırmalarına son



PART LIST PARA LİSTESİ

- 1 **Tupular rivet / Perin**
- 2 **Bearing housing / Kısa tapa**
- 3 **Thrust bearing / Rulman**
- 4 **Cone clutch housing / Tepe diřlisi**
- 5 **One way clutch spring / Diřli yayı**
- 6 **Pinion / Tırnak diřlisi**
- 7 **Thrust bush / 30 luk tapa**
- 8 **O-ring / O-ring**
- 9 **Worm shaft / Sonsuz mil**
- 10 **Grease nipple / Grasörlük**
- 11 **Body / Gövde**
- 12 **Bush / Bur**
- 13 **Spring seat /Arka pulu**
- 14 **Coil spring / Baskı yayı**
- 15 **Spring retainer / Uzun tapa**
- 16 **Welch plug / Pul perin**
- 17 **Return spring-inner / İ tırnak yayı**
- 18 **Return spring-outer / Dıř tırnak yayı**
- 19 **Rack / Toz metal tırnak**
- 20 **O-ring / O-ring**
- 21 **Worm Wheel / Diřli makara**
- 22 **Gasket / Conta**
- 23 **Cover plate / Kapak sacı**
- 24 **Control disk / Kapak borusu**
- 25 **Control arm / Kapak kilidi**
- 26 **Countersunk screw / Vida**

Automatic brake adjuster

Automatic brake adjuster is used in drum brake systems and installed between brake chamber and S- cam shaft. It automatically adjusts the clearance between the drum and lining. Thus; service need, out of order time of the vehicle and air consumption are decreased.

Otomatik Fren Ayar Kolu

Otomatik fren Ayar Kolu havalı kampana fren sisteminde, hava körüğü ile S- kam mili arasına bağlanır. Bořluk hissetme prensibine göre alışan otomatik fren ayar kolu, bütün tip ağır ticari taşıtlar için binlerce farklı modeli mevcuttur.



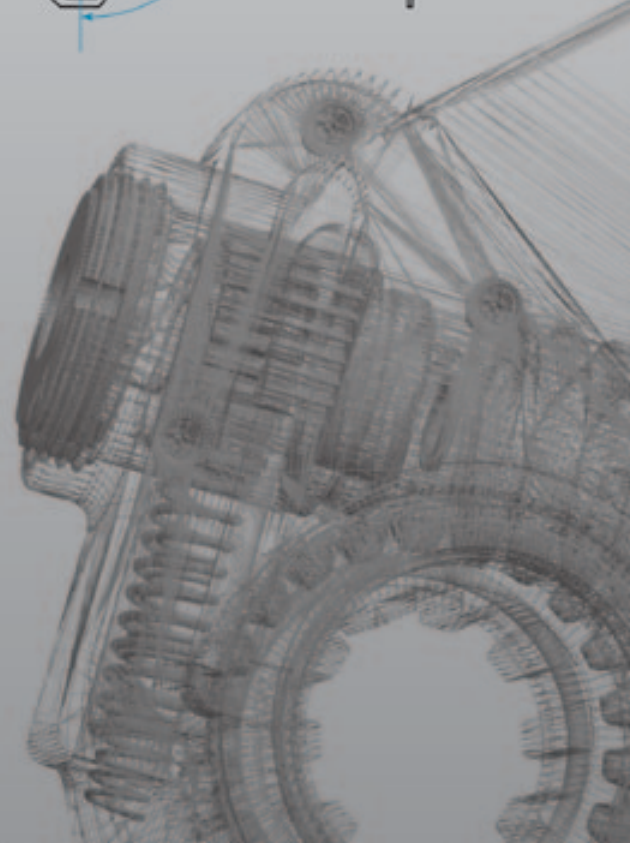
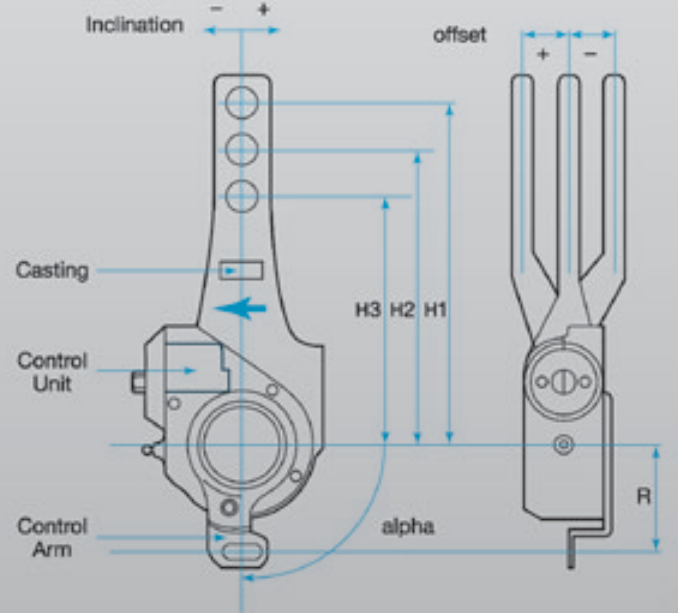







Description for Automatic Brake Adjuster



D-C

D-C		3078 AYS CODE 250100 PART NUMBER 70706 AYS S-ABA CODE 801560 OEM NO KB2440	D-C		3202 AYS CODE 250200 PART NUMBER 70775 AYS S-ABA CODE 801850 OEM NO KB2100	D-C		3163 AYS CODE 250400 PART NUMBER 70754 AYS S-ABA CODE 801725 OEM NO KB2765
D-C		3162 AYS CODE 250500 PART NUMBER 72812 AYS S-ABA CODE 801700 OEM NO 4W3820	D-C		3163 AYS CODE 250600 PART NUMBER 72811 AYS S-ABA CODE 801705 OEM NO 4W3815	D-C		3162 AYS CODE 250700 PART NUMBER 72810 AYS S-ABA CODE 801700 OEM NO 4W3155
D-C		3163 AYS CODE 250800 PART NUMBER 72809 AYS S-ABA CODE 801705 OEM NO KB2930	D-C		3185 AYS CODE 250900 PART NUMBER 72173 AYS S-ABA CODE 801825 OEM NO KB2160	D-C		3186 AYS CODE 251000 PART NUMBER 72174 AYS S-ABA CODE 801830 OEM NO KB2155
D-C		3185 AYS CODE 251100 PART NUMBER CS AYS S-ABA CODE 801815 OEM NO	D-C		3186 AYS CODE 251200 PART NUMBER CS AYS S-ABA CODE 801820 OEM NO	D-C		3185 AYS CODE 251300 PART NUMBER 70918 AYS S-ABA CODE 801795 OEM NO KB2470

	AYS CODE	CASTING	CONTROL UNIT	APPLICATION	SPLINE TEETH	NO of HOLE	H1	H2	H3	H4	H5	H6	H7	BUSHING (mm)	SPLINE TYPE	CONTROL ARM
A	250100	3078	854	D-C	26	1	115							14	N42x1.5x9H DIN 5480	double bent (short; R=65 mm)
B	250200	3202	864	D-C	26	1	130							14	N42x1.5x9H DIN 5480	double bent (short; R=65 mm)
C	250400	3163	253	D-C	26	1	145							14	N42x1.5x9H DIN 5480	double bent (medium; R=78 mm)
D	250500	3162	512	D-C	26	1	130							14	N42x1.5x9H DIN 5480	double bent (short; R=65 mm)
E	250600	3163	512	D-C	26	1	130							14	N42x1.5x9H DIN 5480	double bent (short; R=65 mm)
F	250700	3162	768	D-C	26	1	130							14	N42x1.5x9H DIN 5480	double bent (short; R=65 mm)
G	250800	3163	768	D-C	26	1	130							14	N42x1.5x9H DIN 5480	double bent (short; R=65 mm)
H	250900	3185	293	D-C	26	1	145							14	N42x1.5x9H DIN 5480	double bent (short; R=65 mm)
I	251000	3186	293	D-C	26	1	145							14	N42x1.5x9H DIN 5480	double bent (short; R=65 mm)
J	251100	3185	692	D-C	26	1	145							14	N42x1.5x9H DIN 5480	double bent (short; R=65 mm)
K	251200	3186	692	D-C	26	1	145							14	N42x1.5x9H DIN 5480	double bent (short; R=65 mm)
L	251300	3185	282	D-C	26	1	145							14	N42x1.5x9H DIN 5480	double bent (short; R=65 mm)

D-C	3186	A		AYS CODE 251400 PART NUMBER 70917 AYS S-ABA CODE 801800 OEM NO KB2840
D-C	3878	B		AYS CODE 251500 PART NUMBER 70953 AYS S-ABA CODE 800010 OEM NO
D-C	3879	C		AYS CODE 251600 PART NUMBER 70952 AYS S-ABA CODE 800005 OEM NO
D-C	3900	D		AYS CODE 251700 PART NUMBER 72596 AYS S-ABA CODE 802575 OEM NO KB2420
D-C	4024	E		AYS CODE 251800 PART NUMBER 70954 AYS S-ABA CODE 801740 OEM NO KB2045
D-C	3900	F		AYS CODE 251900 PART NUMBER 72059 AYS S-ABA CODE 802575 OEM NO KB2040
D-C	4037	G		AYS CODE 252000 PART NUMBER 72213 AYS S-ABA CODE 801570 OEM NO KB2130
D-C	4018	H		AYS CODE 252100 PART NUMBER 72063 AYS S-ABA CODE 800020 OEM NO
D-C	4019	I		AYS CODE 252200 PART NUMBER 72062 AYS S-ABA CODE 800015 OEM NO
D-C	3900	J		AYS CODE 252300 PART NUMBER 79185 AYS S-ABA CODE 802575 OEM NO 4W3365
D-C	3162	K		AYS CODE 252400 PART NUMBER CS AYS S-ABA CODE 801710 OEM NO
D-C	3163	L		AYS CODE 252500 PART NUMBER CS AYS S-ABA CODE 801715 OEM NO

	AYS CODE	CASTING	CONTROL UNIT	APPLICATION	SPLINE TEETH	NO of HOLE	H1	H2	H3	H4	H5	H6	H7	BUSHING (mm)	SPLINE TYPE	CONTROL ARM
A	251400	3186	281	D-C	26	1	145							14	N42x1.5x9H DIN 5480	straight
B	251500	3878	782	D-C	26	1	145							14	N42x1.5x9H DIN 5480	double bent (short; R=65 mm)
C	251600	3879	782	D-C	26	1	145							14	N42x1.5x9H DIN 5480	double bent (short; R=65 mm)
D	251700	3900	885	D-C	26	1	145							14	N42x1.5x9H DIN 5480	double bent (short; R=65 mm)
E	251800	4024	682	D-C	26	1	145							14	N42x1.5x9H DIN 5480	double bent (short; R=65 mm)
F	251900	3900	686	D-C	26	1	145							14	N42x1.5x9H DIN 5480	double bent (short; R=65 mm)
G	252000	4037	476	D-C	26	1	130							14	N42x1.5x9H DIN 5480	double bent (medium; R=78 mm)
H	252100	4018	253	D-C	26	1	145							14	N42x1.5x9H DIN 5480	double bent (medium; R=78 mm)
I	252200	4019	253	D-C	26	1	145							14	N42x1.5x9H DIN 5480	double bent (medium; R=78 mm)
J	252300	3900	294	D-C	26	1	145							14	N42x1.5x9H DIN 5480	double bent (short; R=65 mm)
K	252400	3162	864	D-C	26	1	145							14	N42x1.5x9H DIN 5480	double bent (short; R=65 mm)
L	252500	3163	864	D-C	26	1	145							14	N42x1.5x9H DIN 5480	double bent (short; R=65 mm)



D-C

D-C		3162 AYS CODE 252600 PART NUMBER CS AYS S-ABA CODE 801710 OEM NO	D-C		3163 AYS CODE 252700 PART NUMBER CS AYS S-ABA CODE 801715 OEM NO	D-C		3878 AYS CODE 252800 PART NUMBER 72616 AYS S-ABA CODE 800010 OEM NO
D-C		3879 AYS CODE 252900 PART NUMBER 72617 AYS S-ABA CODE 800005 OEM NO	D-C		4018 AYS CODE 253000 PART NUMBER 72594 AYS S-ABA CODE 800020 OEM NO	D-C		4019 AYS CODE 253101 PART NUMBER 72593 AYS S-ABA CODE 800015 OEM NO
D-C		3878 AYS CODE 253200 PART NUMBER 79073 AYS S-ABA CODE 800010 OEM NO	D-C		3879 AYS CODE 253300 PART NUMBER 79074 AYS S-ABA CODE 800005 OEM NO	D-C		3878 AYS CODE 253400 PART NUMBER 79137 AYS S-ABA CODE 800485 OEM NO HB100047
D-C		3879 AYS CODE 253500 PART NUMBER 79136 AYS S-ABA CODE 800490 OEM NO HB100046	D-C		4018 AYS CODE 253600 PART NUMBER 72235 AYS S-ABA CODE 800020 OEM NO	D-C		4019 AYS CODE 253700 PART NUMBER 72234 AYS S-ABA CODE 800015 OEM NO

	AYS CODE	CASTING	CONTROL UNIT	APPLICATION	SPLINE TEETH	NO of HOLE	H1	H2	H3	H4	H5	H6	H7	BUSHING (mm)	SPLINE TYPE	CONTROL ARM
A	252600	3162	788	D-C	26	1	145							14	N42x1.5x9H DIN 5480	double bent (short; R=65 mm)
B	252700	3163	788	D-C	26	1	145							14	N42x1.5x9H DIN 5480	double bent (short; R=65 mm)
C	252800	3878	802	D-C	26	1	145							14	N42x1.5x9H DIN 5480	double bent (short; R=65 mm)
D	252900	3879	802	D-C	26	1	145							14	N42x1.5x9H DIN 5480	double bent (short; R=65 mm)
E	253000	4018	881	D-C	26	1	145							14	N42x1.5x9H DIN 5480	double bent (medium; R=78 mm)
F	253101	4019	881	D-C	26	1	145							14	N42x1.5x9H DIN 5480	double bent (medium; R=78 mm)
G	253200	3878	809	D-C	26	1	145							14	N42x1.5x9H DIN 5480	double bent (short; R=65 mm)
H	253300	3879	521	D-C	26	1	145							14	N42x1.5x9H DIN 5480	double bent (short; R=65 mm)
I	253400	3878	597	D-C	26	1	145							14	N42x1.5x9H DIN 5480	double bent (short; R=65 mm)
J	253500	3879	597	D-C	26	1	145							14	N42x1.5x9H DIN 5480	double bent (short; R=65 mm)
K	253600	4018	988	D-C	26	1	145							14	N42x1.5x9H DIN 5480	double bent (medium; R=78 mm)
L	253700	4019	988	D-C	26	1	145							14	N42x1.5x9H DIN 5480	double bent (medium; R=78 mm)

D-C	3185	A		AYS CODE 253800 PART NUMBER 72919 AYS S-ABA CODE 801825 OEM NO 6994200538
D-C	3186	B		AYS CODE 253900 PART NUMBER 72920 AYS S-ABA CODE 801830 OEM NO 6994200638
D-C	3185	C		AYS CODE 254000 PART NUMBER 72069 AYS S-ABA CODE 801825 OEM NO 4W2950
D-C	3186	D		AYS CODE 254100 PART NUMBER 72070 AYS S-ABA CODE 801830 OEM NO KB2830
D-C	3185	E		AYS CODE 254200 PART NUMBER 79099 AYS S-ABA CODE 801825 OEM NO
D-C	3186	F		AYS CODE 254300 PART NUMBER 79100 AYS S-ABA CODE 801830 OEM NO 93001236
D-C	3900	G		AYS CODE 254400 PART NUMBER 72056 AYS S-ABA CODE 802580 OEM NO 6234201838
D-C	3860	H		AYS CODE 254500 PART NUMBER 72060 AYS S-ABA CODE 802540 OEM NO 4W3985
D-C	3861	I		AYS CODE 254600 PART NUMBER 72061 AYS S-ABA CODE 802545 OEM NO 4W3990
D-C	3162	J		AYS CODE 283700 PART NUMBER 70753 AYS S-ABA CODE 801720 OEM NO KB2445
D-C	4077	K		AYS CODE 290103 PART NUMBER 72054 AYS S-ABA CODE OEM NO 4W3795
D-C	3195	L		AYS CODE 290200 PART NUMBER 70772 AYS S-ABA CODE OEM NO 4W3125

	AYS CODE	CASTING	CONTROL UNIT	APPLICATION	SPLINE TEETH	NO of HOLE	H1	H2	H3	H4	H5	H6	H7	BUSHING (mm)	SPLINE TYPE	CONTROL ARM
A	253800	3185	621	D-C	26	1	145							14	N42x1.5x9H DIN 5480	double bent (short; R=65 mm)
B	253900	3186	621	D-C	26	1	145							14	N42x1.5x9H DIN 5480	double bent (short; R=65 mm)
C	254000	3185	767	D-C	26	1	145							14	N42x1.5x9H DIN 5480	double bent (short; R=65 mm)
D	254100	3186	767	D-C	26	1	145							14	N42x1.5x9H DIN 5480	double bent (short; R=65 mm)
E	254200	3185	900	D-C	26	1	145							14	N42x1.5x9H DIN 5480	double bent (short; R=65 mm)
F	254300	3186	900	D-C	26	1	145							14	N42x1.5x9H DIN 5480	double bent (short; R=65 mm)
G	254400	3900	274	D-C	26	1	145							14	N42x1.5x9H DIN 5480	double bent (medium; R=78 mm)
H	254500	3860	272	D-C	26	1	145							14	N42x1.5x9H DIN 5480	double bent (medium; R=78 mm)
I	254600	3861	272	D-C	26	1	145							14	N42x1.5x9H DIN 5480	double bent (medium; R=78 mm)
J	283700	3162	253	D-C	26	1	145							14	N42x1.5x9H DIN 5480	double bent (medium; R=78 mm)
K	290103	4077	770	D-C	26	1	145							14	N42x1.5x9H DIN 5480	double bent (short; R=65 mm)
L	290200	3195	255	D-C	26	1	115							14	N42x1.5x9H DIN 5480	double bent (medium; R=78 mm)



D-C

D-C	3196	A		AYS CODE 290300 PART NUMBER 70771 AYS S-ABA CODE OEM NO 4W3130	D-C	4096	B		AYS CODE 303960 PART NUMBER 79186 AYS S-ABA CODE OEM NO 3854207438	D-C	3880	C		AYS CODE 363800 PART NUMBER 70955 AYS S-ABA CODE OEM NO 3814200238
D-C	3881	D		AYS CODE 363810 PART NUMBER 70956 AYS S-ABA CODE OEM NO 3814200338	D-C	4016	E		AYS CODE 369160 PART NUMBER 72064 AYS S-ABA CODE OEM NO 3074201738	D-C	4016	F		AYS CODE 369161 PART NUMBER 72127 AYS S-ABA CODE OEM NO
D-C	4017	G		AYS CODE 369170 PART NUMBER 72065 AYS S-ABA CODE OEM NO 4W3895	D-C	4017	H		AYS CODE 369171 PART NUMBER 72128 AYS S-ABA CODE OEM NO	D-C	3177	I		AYS CODE 371770 PART NUMBER 70805 AYS S-ABA CODE 801735 OEM NO 3894200238
D-C	3896	J		AYS CODE 373960 PART NUMBER 70992 AYS S-ABA CODE 800005 OEM NO 3764200238	D-C	3897	K		AYS CODE 373970 PART NUMBER 70993 AYS S-ABA CODE 800010 OEM NO 3764200338	D-C	4035	L		AYS CODE 377350 PART NUMBER 72211 AYS S-ABA CODE OEM NO KB2715

	AYS CODE	CASTING	CONTROL UNIT	APPLICATION	SPLINE TEETH	NO of HOLE	H1	H2	H3	H4	H5	H6	H7	BUSHING (mm)	SPLINE TYPE	CONTROL ARM
A	290300	3196	255	D-C	26	1	115							14	N42x1.5x9H DIN 5480	double bent (medium; R=78 mm)
B	303960	4096	303	D-C	26	1	145							14	N42x1.5x9H DIN 5480	double bent (medium; R=78 mm)
C	363800	3880	263	D-C	26	1	145							14	N42x1.5x9H DIN 5480	double bent (medium; R=78 mm)
D	363810	3881	263	D-C	26	1	145							14	N42x1.5x9H DIN 5480	double bent (medium; R=78 mm)
E	369160	4016	269	D-C	26	1	145							14	N42x1.5x9H DIN 5480	double bent (short; R=65 mm)
F	369161	4016	269	D-C	26	1	145							14	N42x1.5x9H DIN 5480	double bent (short; R=65 mm)
G	369170	4017	269	D-C	26	1	145							14	N42x1.5x9H DIN 5480	double bent (short; R=65 mm)
H	369171	4017	269	D-C	26	1	145							14	N42x1.5x9H DIN 5480	double bent (short; R=65 mm)
I	371770	3177	371	D-C	26	1	145							14	N42x1.5x9H DIN 5480	double bent (medium; R=78 mm)
J	373960	3896	273	D-C	26	1	145							14	N42x1.5x9H DIN 5480	double bent (short; R=65 mm)
K	373970	3897	273	D-C	26	1	145							14	N42x1.5x9H DIN 5480	double bent (short; R=65 mm)
L	377350	4035	477	D-C	26	1	130							14	N42x1.5x9H DIN 5480	double bent (medium; R=78 mm)

D-C	4036	A		AYS CODE 377360 PART NUMBER 72212 AYS S-ABA CODE OEM NO KB2720
D-C	3166	B		AYS CODE 378660 PART NUMBER 70759 AYS S-ABA CODE OEM NO 3634200138
D-C	3177	C		AYS CODE 382770 PART NUMBER 70867 AYS S-ABA CODE 801735 OEM NO KB2150
D-C	4022	D		AYS CODE 390220 PART NUMBER 72096 AYS S-ABA CODE OEM NO 3574200938
D-C	4023	E		AYS CODE 390230 PART NUMBER 72097 AYS S-ABA CODE OEM NO 3574201038
D-C	4025	F		AYS CODE 391250 PART NUMBER 72120 AYS S-ABA CODE OEM NO 3414201738
D-C	4026	G		AYS CODE 391260 PART NUMBER 72121 AYS S-ABA CODE OEM NO 3414201638
D-C	4085	H		AYS CODE 392850 PART NUMBER 79132 AYS S-ABA CODE 803425 OEM NO 6954207038
D-C	3878	I		AYS CODE 465780 PART NUMBER cs AYS S-ABA CODE 800485 OEM NO
D-C	3879	J		AYS CODE 465790 PART NUMBER cs AYS S-ABA CODE 800490 OEM NO
D-C	4024	K		AYS CODE 469240 PART NUMBER 72046 AYS S-ABA CODE 801740 OEM NO
D-C	4049	L		AYS CODE 475490 PART NUMBER 72178 AYS S-ABA CODE OEM NO 4W3480

	AYS CODE	CASTING	CONTROL UNIT	APPLICATION	SPLINE TEETH	NO of HOLE	H1	H2	H3	H4	H5	H6	H7	BUSHING (mm)	SPLINE TYPE	CONTROL ARM
A	377360	4036	477	D-C	26	1	130							14	N42x1.5x9H DIN 5480	double bent (medium; R=78 mm)
B	378660	3166	378	D-C	19	1	130							14	A38x34 DIN 5482	double bent (short; R=65 mm)
C	382770	3177	482	D-C	26	1	145							14	N42x1.5x9H DIN 5480	double bent (medium; R=78 mm)
D	390220	4022	290	D-C	26	1	145							14	N42x1.5x9H DIN 5480	double bent (medium; R=78 mm)
E	390230	4023	290	D-C	26	1	145							14	N42x1.5x9H DIN 5480	double bent (medium; R=78 mm)
F	391250	4025	291	D-C	26	1	145							14	N42x1.5x9H DIN 5480	double bent (short; R=65 mm)
G	391260	4026	291	D-C	26	1	145							14	N42x1.5x9H DIN 5480	double bent (short; R=65 mm)
H	392850	4085	292	D-C	26	1	145							14	N42x1.5x9H DIN 5480	double bent (short; R=65 mm)
I	465780	3878	565	D-C	26	1	145							14	N42x1.5x9H DIN 5480	double bent (short; R=65 mm)
J	465790	3879	565	D-C	26	1	145							14	N42x1.5x9H DIN 5480	double bent (short; R=65 mm)
K	469240	4024	769	D-C	26	1	145							14	N42x1.5x9H DIN 5480	double bent (short; R=65 mm)
L	475490	4049	575	D-C	26	1	145							14	N42x1.5x9H DIN 5480	double bent (medium; R=78 mm)



ABA
Automatic Brake Adjuster / Otomatik Fren Ayar Kolu.
S-ABA
(Self Setting) Automatic Brake Adjuster / Tam Otomatik Fren Ayar Kolu.

* CS > Customer Specific / Özel İmalat













PRODUCT PICTURES ARE TAKEN OF REFERENCE FOR CASTING BODIES. ALSO PLEASE IGNORE CONTROL UNIT & ITS POSITION. ÜRÜN FOTOĞRAFLARI GÖVDELER REFERANS ALINARAK YERLEŞTİRİLMİŞTİR. KİLİT VE KİLİT AÇILARINI DİKKATE ALMAYINIZ.

ALL ORIGINAL NUMBERS, MARKS AND MODELS FROM VEHICLE MANUFACTURERS LISTED IN THIS CATALOGUE ARE FOR COMPARISON PURPOSES ONLY AND MAY NOT BE USED IN INVOICES TO VEHICLE OWNERS OR RESELLERS. / ORJINAL ÜRÜN NUMARALARI MÜŞTERİYİ BİLGİLENDİRME VE ÜRÜNE REFERANS AMAÇLI KULLANILMIŞTIR.

D-C

D-C		3892 AYS CODE 484920 PART NUMBER 72037 AYS S-ABA CODE 800025 OEM NO	D-C		3893 AYS CODE 484930 PART NUMBER 72036 AYS S-ABA CODE 800030 OEM NO	D-C		4010 AYS CODE 485100 PART NUMBER 72040 AYS S-ABA CODE 800035 OEM NO
D-C		4011 AYS CODE 485110 PART NUMBER 72041 AYS S-ABA CODE 800040 OEM NO	D-C		4004 AYS CODE 487040 PART NUMBER 72038 AYS S-ABA CODE OEM NO 4W2750	D-C		4005 AYS CODE 487050 PART NUMBER 72039 AYS S-ABA CODE OEM NO KB2755
D-C		4068 AYS CODE 501680 PART NUMBER 72597 AYS S-ABA CODE OEM NO 4W3105	D-C		4069 AYS CODE 501690 PART NUMBER 72598 AYS S-ABA CODE OEM NO 4W3110	D-C		3216 AYS CODE 563160 PART NUMBER 70789 AYS S-ABA CODE OEM NO 3894205438
D-C		4078 AYS CODE 570780 PART NUMBER 72055 AYS S-ABA CODE OEM NO 4W3800	D-C		2866 AYS CODE 583660 PART NUMBER 70519 AYS S-ABA CODE OEM NO 3054200538	D-C		2882 AYS CODE 584820 PART NUMBER 70518 AYS S-ABA CODE OEM NO 3054200438

	AYS CODE	CASTING	CONTROL UNIT	APPLICATION	SPLINE TEETH	NO of HOLE	H1	H2	H3	H4	H5	H6	H7	BUSHING (mm)	SPLINE TYPE	CONTROL ARM
A	484920	3892	684	D-C	26	1	145							14	N42x1.5x9H DIN 5480	double bent (short; R=65 mm)
B	484930	3893	684	D-C	26	1	145							14	N42x1.5x9H DIN 5480	double bent (short; R=65 mm)
C	485100	4010	685	D-C	26	1	145							14	N42x1.5x9H DIN 5480	double bent (short; R=65 mm)
D	485110	4011	685	D-C	26	1	145							14	N42x1.5x9H DIN 5480	double bent (short; R=65 mm)
E	487040	4004	687	D-C	26	1	145							14	N42x1.5x9H DIN 5480	double bent (short; R=65 mm)
F	487050	4005	687	D-C	26	1	145							14	N42x1.5x9H DIN 5480	double bent (short; R=65 mm)
G	501680	4068	801	D-C	26	1	145							14	N42x1.5x9H DIN 5480	double bent (medium; R=78 mm)
H	501690	4069	801	D-C	26	1	145							14	N42x1.5x9H DIN 5480	double bent (medium; R=78 mm)
I	563160	3216	863	D-C	26	1	215							14	N42x1.5x9H DIN 5480	double bent (short; R=65 mm)
J	570780	4078	770	D-C	26	1	145							14	N42x1.5x9H DIN 5480	double bent (short; R=65 mm)
K	583660	2866	883	D-C	19	1	105							14	A38x34 DIN 5482	double bent (short; R=65 mm)
L	584820	2882	884	D-C	19	1	110							14	A38x34 DIN 5482	double bent (short; R=65 mm)

D-C	2882	A		AYS CODE 584821 PART NUMBER 70702 AYS S-ABA CODE OEM NO 3054202738	D-C	2882	B		AYS CODE 584822 PART NUMBER 70950 AYS S-ABA CODE OEM NO 6254200638	D-C	4052	C		AYS CODE 586520 PART NUMBER 72354 AYS S-ABA CODE OEM NO 3074202138
D-C	4053	D		AYS CODE 586530 PART NUMBER 72355 AYS S-ABA CODE OEM NO 3074202238	D-C	3194	E		AYS CODE 588940 PART NUMBER 70870 AYS S-ABA CODE 801845 OEM NO 6234200938	D-C	4044	F		AYS CODE 599440 PART NUMBER 70991 AYS S-ABA CODE 801710 OEM NO 4W3290
D-C	4045	G		AYS CODE 599450 PART NUMBER 70990 AYS S-ABA CODE 801715 OEM NO 4W3285	MAN	3070	H		AYS CODE 280100 PART NUMBER cs AYS S-ABA CODE 801630 OEM NO	MAN	3071	I		AYS CODE 280200 PART NUMBER cs AYS S-ABA CODE 801635 OEM NO
MAN	3070	J		AYS CODE 280300 PART NUMBER 79223 AYS S-ABA CODE 801630 OEM NO MAN6001	MAN	3071	K		AYS CODE 280400 PART NUMBER 79224 AYS S-ABA CODE 801635 OEM NO MAN60501	MAN	3162	L		AYS CODE 280500 PART NUMBER 79229 AYS S-ABA CODE 801700 OEM NO 4W3345

	AYS CODE	CASTING	CONTROL UNIT	APPLICATION	SPLINE TEETH	NO of HOLE	H1	H2	H3	H4	H5	H6	H7	BUSHING (mm)	SPLINE TYPE	CONTROL ARM
A	584821	2882	884	D-C	19	1	110							14	A38x34 DIN 5482	double bent (short; R=65 mm)
B	584822	2882	884	D-C	26	1	110							14	N42x1.5x9H DIN 5480	double bent (short; R=65 mm)
C	586520	4052	886	D-C	26	1	145							14	N42x1.5x9H DIN 5480	double bent (short; R=65 mm)
D	586530	4053	886	D-C	26	1	145							14	N42x1.5x9H DIN 5480	double bent (short; R=65 mm)
E	588940	3194	888	D-C	26	1	110							14	N42x1.5x9H DIN 5480	double bent (short; R=65 mm)
F	599440	4044	799	D-C	26	1	145							14	N42x1.5x9H DIN 5480	double bent (short; R=65 mm)
G	599450	4045	799	D-C	26	1	145							14	N42x1.5x9H DIN 5480	double bent (short; R=65 mm)
H	280100	3070	861	MAN	26	1	215							14	N42x1.5x9H DIN 5480	double bent (short; R=65 mm)
I	280200	3071	861	MAN	26	1	215							14	N42x1.5x9H DIN 5480	double bent (short; R=65 mm)
J	280300	3070	564	MAN	26	1	215							14	N42x1.5x9H DIN 5480	double bent (short; R=65 mm)
K	280400	3071	564	MAN	26	1	215							14	N42x1.5x9H DIN 5480	double bent (short; R=65 mm)
L	280500	3162	512	MAN	26	1	130							14	N42x1.5x9H DIN 5480	double bent (short; R=65 mm)



MAN

MAN	3163	A		AYS CODE 280600 PART NUMBER 79228 AYS S-ABA CODE 801705 OEM NO 4W3350
MAN	3162	B		AYS CODE 280700 PART NUMBER 79220 AYS S-ABA CODE 801700 OEM NO 815061025181
MAN	3163	C		AYS CODE 280800 PART NUMBER 79219 AYS S-ABA CODE 801705 OEM NO 815061024182
MAN	3162	D		AYS CODE 280900 PART NUMBER 79210 AYS S-ABA CODE 801720 OEM NO KB2095
MAN	3163	E		AYS CODE 281000 PART NUMBER 79211 AYS S-ABA CODE 801725 OEM NO KB2090
MAN	3162	F		AYS CODE 281100 PART NUMBER cs AYS S-ABA CODE 801720 OEM NO
MAN	3163	G		AYS CODE 281200 PART NUMBER cs AYS S-ABA CODE 801725 OEM NO
MAN	3177	H		AYS CODE 281300 PART NUMBER cs AYS S-ABA CODE 801735 OEM NO
MAN	3177	I		AYS CODE 281400 PART NUMBER 79212 AYS S-ABA CODE 801735 OEM NO KB2080
MAN	3185	J		AYS CODE 281500 PART NUMBER 79208 AYS S-ABA CODE 801805 OEM NO MAN60003
MAN	3186	K		AYS CODE 281600 PART NUMBER 79209 AYS S-ABA CODE 801810 OEM NO MAN60004
MAN	3195	L		AYS CODE 281900 PART NUMBER 79203 AYS S-ABA CODE OEM NO 815061040183

	AYS CODE	CASTING	CONTROL UNIT	APPLICATION	SPLINE TEETH	NO of HOLE	H1	H2	H3	H4	H5	H6	H7	BUSHING (mm)	SPLINE TYPE	CONTROL ARM
A	280600	3163	512	MAN	26	1	130							14	N42x1.5x9H DIN 5480	double bent (short; R=65 mm)
B	280700	3162	768	MAN	26	1	130							14	N42x1.5x9H DIN 5480	double bent (short; R=65 mm)
C	280800	3163	768	MAN	26	1	130							14	N42x1.5x9H DIN 5480	double bent (short; R=65 mm)
D	280900	3162	785	MAN	26	1	145							14	N42x1.5x9H DIN 5480	double bent (medium; R=78 mm)
E	281000	3163	785	MAN	26	1	145							14	N42x1.5x9H DIN 5480	double bent (medium; R=78 mm)
F	281100	3162	258	MAN	26	1	145							14	N42x1.5x9H DIN 5480	double bent (medium; R=78 mm)
G	281200	3163	258	MAN	26	1	145							14	N42x1.5x9H DIN 5480	double bent (medium; R=78 mm)
H	281300	3177	259	MAN	26	1	145							14	N42x1.5x9H DIN 5480	double bent (medium; R=78 mm)
I	281400	3177	566	MAN	26	1	145							14	N42x1.5x9H DIN 5480	double bent (medium; R=78 mm)
J	281500	3185	565	MAN	26	1	145							14	N42x1.5x12H DIN 5480	double bent (short; R=65 mm)
K	281600	3186	565	MAN	26	1	145							14	N42x1.5x9H DIN 5480	double bent (short; R=65 mm)
L	281900	3195	789	MAN	26	1	115							14	N42x1.5x9H DIN 5480	double bent (medium; R=78 mm)

MAN	3196	AYS CODE 282000	PART NUMBER 79204	AYS S-ABA CODE	OEM NO 815061041184	MAN	3226	AYS CODE 282101	PART NUMBER 79215	AYS S-ABA CODE 800875	OEM NO 815061015167	MAN	3522	AYS CODE 282200	PART NUMBER 79225	AYS S-ABA CODE	OEM NO L1850087
MAN	3523	AYS CODE 282300	PART NUMBER 79226	AYS S-ABA CODE	OEM NO L1850096	MAN	3522	AYS CODE 282400	PART NUMBER cs	AYS S-ABA CODE	OEM NO	MAN	3523	AYS CODE 282500	PART NUMBER cs	AYS S-ABA CODE	OEM NO
MAN	3522	AYS CODE 282600	PART NUMBER cs	AYS S-ABA CODE	OEM NO	MAN	3523	AYS CODE 282700	PART NUMBER cs	AYS S-ABA CODE	OEM NO	MAN	3878	AYS CODE 282800	PART NUMBER 79205	AYS S-ABA CODE 800010	OEM NO KB2610
MAN	3879	AYS CODE 282900	PART NUMBER 79206	AYS S-ABA CODE 800005	OEM NO KB2615	MAN	4027	AYS CODE 283000	PART NUMBER 79217	AYS S-ABA CODE	OEM NO ESXBU1032	MAN	4028	AYS CODE 283100	PART NUMBER 79216	AYS S-ABA CODE	OEM NO ESXBU1024

	AYS CODE	CASTING	CONTROL UNIT	APPLICATION	SPLINE TEETH	NO of HOLE	H1	H2	H3	H4	H5	H6	H7	BUSHING (mm)	SPLINE TYPE	CONTROL ARM
A	282000	3196	789	MAN	26	1	115							14	N42x1.5x9H DIN 5480	double bent (medium; R=78 mm)
B	282101	3226	887	MAN	26	1	130							14	N42x1.5x9H DIN 5480	double bent (short; R=65 mm)
C	282200	3522	788	MAN	26	1	130							14	N42x1.5x9H DIN 5480	double bent (short; R=65 mm)
D	282300	3523	788	MAN	26	1	130							14	N42x1.5x9H DIN 5480	double bent (short; R=65 mm)
E	282400	3522	862	MAN	26	1	130							14	N42x1.5x9H DIN 5480	double bent (short; R=65 mm)
F	282500	3523	862	MAN	26	1	130							14	N42x1.5x9H DIN 5480	double bent (short; R=65 mm)
G	282600	3522	885	MAN	26	1	130							14	N42x1.5x9H DIN 5480	double bent (short; R=65 mm)
H	282700	3523	885	MAN	26	1	130							14	N42x1.5x9H DIN 5480	double bent (short; R=65 mm)
I	282800	3878	688	MAN	26	1	145							14	N42x1.5x9H DIN 5480	double bent (short; R=65 mm)
J	282900	3879	688	MAN	26	1	145							14	N42x1.5x9H DIN 5480	double bent (short; R=65 mm)
K	283000	4027	688	MAN	26	1	130							14	N42x1.5x9H DIN 5480	double bent (short; R=65 mm)
L	283100	4028	688	MAN	26	1	130							14	N42x1.5x9H DIN 5480	double bent (short; R=65 mm)



ABA
Automatic Brake Adjuster / Otomatik Fren Ayar Kolu.
S-ABA
(Self Setting) Automatic Brake Adjuster / Tam Otomatik Fren Ayar Kolu.

* CS > Customer Specific / Özel İmalat













PRODUCT PICTURES ARE TAKEN OF REFERENCE FOR CASTING BODIES. ALSO PLEASE IGNORE CONTROL UNIT & ITS POSITION. ÜRÜN FOTOĞRAFLARI GÖVDELER REFERANS ALINARAK YERLEŞTİRİLMİŞTİR. KİLİT VE KİLİT AÇILARINI DİKKATE ALMAYINIZ.

ALL ORIGINAL NUMBERS, MARKS AND MODELS FROM VEHICLE MANUFACTURERS LISTED IN THIS CATALOGUE ARE FOR COMPARISON PURPOSES ONLY AND MAY NOT BE USED IN INVOICES TO VEHICLE OWNERS OR RESELLERS. / ORJİNAL ÜRÜN NUMARALARI MÜŞTERİYİ BİLGİLENDİRME VE ÜRÜNE REFERANS AMAÇLI KULLANILMIŞTIR.

MAN

MAN	4104	MAN	2752	MAN	3226
A		B		C	
	AYS CODE 283200 PART NUMBER 79218 AYS S-ABA CODE 803415 OEM NO 815061023180		AYS CODE 283300 PART NUMBER 79207 AYS S-ABA CODE 803425 OEM NO 4W3400		AYS CODE 283400 PART NUMBER CS AYS S-ABA CODE 800870 OEM NO
MAN	3878	MAN	3879	MAN	3878
D		E		F	
	AYS CODE 283500 PART NUMBER CS AYS S-ABA CODE 800010 OEM NO		AYS CODE 283600 PART NUMBER CS AYS S-ABA CODE 800005 OEM NO		AYS CODE 369780 PART NUMBER CS AYS S-ABA CODE 800495 OEM NO
MAN	3879	MAN	3896	MAN	3162
G		H		I	
	AYS CODE 369790 PART NUMBER CS AYS S-ABA CODE 800500 OEM NO		AYS CODE 410960 PART NUMBER 72650 AYS S-ABA CODE		AYS CODE 412620 PART NUMBER 72732 AYS S-ABA CODE 801700 OEM NO
MAN	3163	MAN	2752	MAN	3214
J		K		L	
	AYS CODE 412630 PART NUMBER 72731 AYS S-ABA CODE 801705 OEM NO		AYS CODE 413520 PART NUMBER 72865 AYS S-ABA CODE 803425 OEM NO		AYS CODE 464140 PART NUMBER 79200 AYS S-ABA CODE OEM NO 815061029087













	AYS CODE	CASTING	CONTROL UNIT	APPLICATION	SPLINE TEETH	NO of HOLE	H1	H2	H3	H4	H5	H6	H7	BUSHING (mm)	SPLINE TYPE	CONTROL ARM
A	283200	4104	599	MAN	26	1	130							14	N42x1.5x9H DIN 5480	double bent (short; R=65 mm)
B	283300	2752	480	MAN	26	1	145							14	N42x1.5x9H DIN 5480	double bent (short; R=65 mm)
C	283400	3226	565	MAN	26	1	130							14	N42x1.5x9H DIN 5480	double bent (short; R=65 mm)
D	283500	3878	885	MAN	26	1	145							14	N42x1.5x9H DIN 5480	double bent (short; R=65 mm)
E	283600	3879	885	MAN	26	1	145							14	N42x1.5x9H DIN 5480	double bent (short; R=65 mm)
F	369780	3878	169	MAN	26	1	145								N42x1.5x9H DIN 5480	bent
G	369790	3879	169	MAN	26	1	145								N42x1.5x9H DIN 5480	bent
H	410960	3896	510	MAN	26	1	145							14	N42x1.5x9H DIN 5480	double bent (medium; R=78 mm)
I	412620	3162	512	MAN	26	1	130							14	N42x1.5x9H DIN 5480	double bent (short; R=65 mm)
J	412630	3163	512	MAN	26	1	130							14	N42x1.5x9H DIN 5480	double bent (short; R=65 mm)
K	413520	2752	613	MAN	26	1	145							14	N42x1.5x9H DIN 5480	double bent (short; R=65 mm)
L	464140	3214	564	MAN	26	2	250	210						14	N42x1.5x9H DIN 5480	double bent (short; R=65 mm)

MAN	3215	3070	3071
A		B	
C		D	
E		F	
G		H	
I		J	
K		L	

	AYS CODE	CASTING	CONTROL UNIT	APPLICATION	SPLINE TEETH	NO of HOLE	H1	H2	H3	H4	H5	H6	H7	BUSHING (mm)	SPLINE TYPE	CONTROL ARM
A	464150	3215	564	MAN	26	2	250	210						14	N42x1.5x9H DIN 5480	double bent (short; R=65 mm)
B	464700	3070	564	MAN	26	1	215							14	N42x1.5x9H DIN 5480	double bent (short; R=65 mm)
C	464710	3071	564	MAN	26	1	215							14	N42x1.5x9H DIN 5480	double bent (short; R=65 mm)
D	465850	3185	565	MAN	26	1	145							14	N42x1.5x9H DIN 5480	double bent (short; R=65 mm)
E	465852	3185	565	MAN	26	1	145							14	N42x1.5x12H DIN 5480	double bent (short; R=65 mm)
F	465860	3186	565	MAN	26	1	145							14	N42x1.5x9H DIN 5480	double bent (short; R=65 mm)
G	465862	3186	565	MAN	26	1	145							14	N42x1.5x9H DIN 5480	double bent (short; R=65 mm)
H	466770	3177	566	MAN	26	1	145							14	N42x1.5x9H DIN 5480	double bent (medium; R=78 mm)
I	474850	4085	574	MAN	26	1	145							14	N42x1.5x9H DIN 5480	double bent (short; R=65 mm)
J	488790	3879	688	MAN	26	1	145							14	N42x1.5x9H DIN 5480	double bent (short; R=65 mm)
K	489521	2752	689	MAN	26	1	145							14	N42x1.5x9H DIN 5480	double bent (short; R=65 mm)
L	490520	2752	690	MAN	26	1	150							14	N42x1.5x9H DIN 5480	double bent (short; R=65 mm)



MAN

MAN	2897	A		AYS CODE 498970 PART NUMBER 70615 AYS S-ABA CODE OEM NO 81506106067	MAN	4104	B		AYS CODE 499040 PART NUMBER 72438 AYS S-ABA CODE 803415 OEM NO	MAN	4046	C		AYS CODE 500460 PART NUMBER 72338 AYS S-ABA CODE OEM NO
MAN	4046	D		AYS CODE 500461 PART NUMBER 79214 AYS S-ABA CODE OEM NO 815061011175	MAN	4047	E		AYS CODE 500470 PART NUMBER 72337 AYS S-ABA CODE OEM NO	MAN	4047	F		AYS CODE 500471 PART NUMBER 79213 AYS S-ABA CODE OEM NO MAN60502
MAN	3166	G		AYS CODE 562660 PART NUMBER 79194 AYS S-ABA CODE OEM NO 81506106082	MAN	3216	H		AYS CODE 563161 PART NUMBER 72506 AYS S-ABA CODE OEM NO	MAN	3216	I		AYS CODE 563162 PART NUMBER 79197 AYS S-ABA CODE OEM NO 815061026189
MAN	3216	J		AYS CODE 563163 PART NUMBER 79221 AYS S-ABA CODE OEM NO 815061030191	MAN	3217	K		AYS CODE 563170 PART NUMBER 72507 AYS S-ABA CODE OEM NO	MAN	3217	L		AYS CODE 563171 PART NUMBER 79198 AYS S-ABA CODE OEM NO 815061027190

	AYS CODE	CASTING	CONTROL UNIT	APPLICATION	SPLINE TEETH	NO of HOLE	H1	H2	H3	H4	H5	H6	H7	BUSHING (mm)	SPLINE TYPE	CONTROL ARM
A	498970	2897	598	MAN	20	1	215							14	A40x36 DIN 5482	bent
B	499040	4104	599	MAN	26	1	130							14	N42x1.5x9H DIN 5480	double bent (short; R=65 mm)
C	500460	4046	800	MAN	26	1	145							14	N42x1.5x9H DIN 5480	double bent (short; R=65 mm)
D	500461	4046	800	MAN	26	1	145							14	N42x1.5x9H DIN 5480	double bent (short; R=65 mm)
E	500470	4047	800	MAN	26	1	145							14	N42x1.5x9H DIN 5480	double bent (short; R=65 mm)
F	500471	4047	800	MAN	26	1	145							14	N42x1.5x9H DIN 5480	double bent (short; R=65 mm)
G	562660	3166	862	MAN	26	1	130							14	N42x1.5x9H DIN 5480	double bent (short; R=65 mm)
H	563161	3216	863	MAN	26	1	215							14	N42x1.5x9H DIN 5480	double bent (short; R=65 mm)
I	563162	3216	863	MAN	26	1	215							14	N42x1.5x9H DIN 5480	double bent (short; R=65 mm)
J	563163	3216	863	MAN	26	1	215							14	N42x1.5x9H DIN 5480	double bent (short; R=65 mm)
K	563170	3217	863	MAN	26	1	215							14	N42x1.5x9H DIN 5480	double bent (short; R=65 mm)
L	563171	3217	863	MAN	26	1	215							14	N42x1.5x9H DIN 5480	double bent (short; R=65 mm)

MAN	3217	AYS CODE 563172	PART NUMBER 79222	AYS S-ABA CODE	OEM NO 815061031192	MAN	4056	AYS CODE 563560	PART NUMBER 79694	AYS S-ABA CODE	OEM NO	MAN	4057	AYS CODE 563570	PART NUMBER 79693	AYS S-ABA CODE	OEM NO 815061017173
MAN	3226	AYS CODE 566260	PART NUMBER 79202	AYS S-ABA CODE 800875	OEM NO 815061039091	MAN	2897	AYS CODE 572970	PART NUMBER 79201	AYS S-ABA CODE	OEM NO 815061037101	MAN	4030	AYS CODE 589300	PART NUMBER 79195	AYS S-ABA CODE	OEM NO 815061012161
MAN	4031	AYS CODE 589310	PART NUMBER 79196	AYS S-ABA CODE	OEM NO 815061013160	SCANIA	3226	AYS CODE 230100	PART NUMBER 72662	AYS S-ABA CODE 800790	OEM NO SCA64506	SCANIA	3662	AYS CODE 230300	PART NUMBER 72660	AYS S-ABA CODE 801855	OEM NO SCA64502
SCANIA	3663	AYS CODE 230400	PART NUMBER 72661	AYS S-ABA CODE 801860	OEM NO XBU1001	SCANIA	3662	AYS CODE 230500	PART NUMBER CS	AYS S-ABA CODE 801855	OEM NO	SCANIA	3663	AYS CODE 230600	PART NUMBER CS	AYS S-ABA CODE 801860	OEM NO













	AYS CODE	CASTING	CONTROL UNIT	APPLICATION	SPLINE TEETH	NO of HOLE	H1	H2	H3	H4	H5	H6	H7	BUSHING (mm)	SPLINE TYPE	CONTROL ARM
A	563172	3217	863	MAN	26	1	215							14	N42x1.5x9H DIN 5480	double bent (short; R=65 mm)
B	563560	4056	563	MAN	26	1	190							14	N42x1.5x9H DIN 5480	double bent (medium; R=78 mm)
C	563570	4057	563	MAN	26	1	190							14	N42x1.5x9H DIN 5480	double bent (medium; R=78 mm)
D	566260	3226	866	MAN	26	1	130							14	N42x1.5x9H DIN 5480	double bent (short; R=65 mm)
E	572970	2897	872	MAN	26	1	215							14	N42x1.5x9H DIN 5480	double bent (short; R=65 mm)
F	589300	4030	989	MAN	26	1	145							14	N42x1.5x9H DIN 5480	double bent (short; R=65 mm)
G	589310	4031	989	MAN	26	1	145							14	N42x1.5x9H DIN 5480	double bent (short; R=65 mm)
H	230100	3226	230	SCANIA	10	1	165							16	SAE 1 1/2" 10 C	double bent (long; R=100 mm)
I	230300	3662	230	SCANIA	10	1	165							16	SAE 1 1/2" 10 C	double bent (long; R=100 mm)
J	230400	3663	230	SCANIA	10	1	165							16	SAE 1 1/2" 10 C	double bent (long; R=100 mm)
K	230500	3662	453	SCANIA	10	1	165							14	SAE 1 1/2" 10 C	double bent (long; R=100 mm)
L	230600	3663	453	SCANIA	10	1	165							14	SAE 1 1/2" 10 C	double bent (long; R=100 mm)



SCANIA

SCANIA	3704	SCANIA	3705	SCANIA	3068
A		B		C	
	AYS CODE 230700 PART NUMBER 72664 AYS S-ABA CODE 801895 OEM NO KB2850		AYS CODE 230800 PART NUMBER 72663 AYS S-ABA CODE 801900 OEM NO KB2680		AYS CODE 230900 PART NUMBER 79249 AYS S-ABA CODE 801290 OEM NO
SCANIA	3069	SCANIA	3891	SCANIA	4104
D		E		F	
	AYS CODE 231000 PART NUMBER 79248 AYS S-ABA CODE 801295 OEM NO		AYS CODE 231100 PART NUMBER 72654 AYS S-ABA CODE 803070 OEM NO KB2710		AYS CODE 231200 PART NUMBER 72910 AYS S-ABA CODE 802855 OEM NO 311508
SCANIA	3704	SCANIA	3705	SCANIA	2985
G		H		I	
	AYS CODE 231300 PART NUMBER cs AYS S-ABA CODE 801875 OEM NO		AYS CODE 231400 PART NUMBER cs AYS S-ABA CODE 801880 OEM NO		AYS CODE 231500 PART NUMBER 72745 AYS S-ABA CODE 802660 OEM NO XBU1009
SCANIA	2987	SCANIA	3704	SCANIA	3705
J		K		L	
	AYS CODE 231600 PART NUMBER 72744 AYS S-ABA CODE 802665 OEM NO KB2270		AYS CODE 231700 PART NUMBER 72665 AYS S-ABA CODE 801895 OEM NO KB2520		AYS CODE 231800 PART NUMBER 72666 AYS S-ABA CODE 801900 OEM NO KB2525











	AYS CODE	CASTING	CONTROL UNIT	APPLICATION	SPLINE TEETH	NO of HOLE	H1	H2	H3	H4	H5	H6	H7	BUSHING (mm)	SPLINE TYPE	CONTROL ARM
A	230700	3704	229	SCANIA	10	1	165							16	SAE 1 1/2" 10 C	double bent (short; R=65 mm)
B	230800	3705	229	SCANIA	10	1	165							16	SAE 1 1/2" 10 C	double bent (short; R=65 mm)
C	230900	3068	171	SCANIA	10	1	178							14	SAE 1 1/2" 10 C	ays-saddle type
D	231000	3069	171	SCANIA	10	1	178							14	SAE 1 1/2" 10 C	ays-saddle type
E	231100	3891	230	SCANIA	10	2	165	140						16	SAE 1 1/2" 10 C	double bent (long; R=100 mm)
F	231200	4104	453	SCANIA	10	1	130							16	SAE 1 1/2" 10 C	double bent (long; R=100 mm)
G	231300	3704	294	SCANIA	10	1	165							14	SAE 1 1/2" 10 C	double bent (short; R=65 mm)
H	231400	3705	294	SCANIA	10	1	165							14	SAE 1 1/2" 10 C	double bent (short; R=65 mm)
I	231500	2985	453	SCANIA	10	1	165							16	SAE 1 1/2" 10 C	double bent (long; R=100 mm)
J	231600	2987	453	SCANIA	10	1	165							16	SAE 1 1/2" 10 C	double bent (long; R=100 mm)
K	231700	3704	232	SCANIA	10	1	165							16	SAE 1 1/2" 10 C	double bent (short; R=65 mm)
L	231800	3705	232	SCANIA	10	1	165							16	SAE 1 1/2" 10 C	double bent (short; R=65 mm)

SCANIA	3704	SCANIA	3705	SCANIA	3704
A		B		C	
	AYS CODE 231900 PART NUMBER 72952 AYS S-ABA CODE 801895 OEM NO		AYS CODE 232000 PART NUMBER 72951 AYS S-ABA CODE 801900 OEM NO		AYS CODE 232100 PART NUMBER 72954 AYS S-ABA CODE 801895 OEM NO
SCANIA	3705	SCANIA	3662	SCANIA	3663
D		E		F	
	AYS CODE 232200 PART NUMBER 72955 AYS S-ABA CODE 801900 OEM NO		AYS CODE 232300 PART NUMBER 72949 AYS S-ABA CODE 801855 OEM NO		AYS CODE 232400 PART NUMBER 72950 AYS S-ABA CODE 801860 OEM NO
SCANIA	4020	SCANIA	4021	SCANIA	4040
G		H		I	
	AYS CODE 233200 PART NUMBER 79348 AYS S-ABA CODE OEM NO 4W3540		AYS CODE 233210 PART NUMBER 79347 AYS S-ABA CODE OEM NO 4W3545		AYS CODE 235400 PART NUMBER 72825 AYS S-ABA CODE OEM NO XBU1010
SCANIA	4041	SCANIA	4083	SCANIA	4084
J		K		L	
	AYS CODE 235410 PART NUMBER 72826 AYS S-ABA CODE OEM NO XBU1012		AYS CODE 235830 PART NUMBER 79442 AYS S-ABA CODE 801650 OEM NO KB2735		AYS CODE 235840 PART NUMBER 79443 AYS S-ABA CODE 801655 OEM NO KB2740













	AYS CODE	CASTING	CONTROL UNIT	APPLICATION	SPLINE TEETH	NO of HOLE	H1	H2	H3	H4	H5	H6	H7	BUSHING (mm)	SPLINE TYPE	CONTROL ARM
A	231900	3704	760	SCANIA	10	1	165							16	SAE 1 1/2" 10 C	double bent (short; R=65 mm)
B	232000	3705	760	SCANIA	10	1	165							16	SAE 1 1/2" 10 C	double bent (short; R=65 mm)
C	232100	3704	761	SCANIA	10	1	165							16	SAE 1 1/2" 10 C	double bent (short; R=65 mm)
D	232200	3705	761	SCANIA	10	1	165							16	SAE 1 1/2" 10 C	double bent (short; R=65 mm)
E	232300	3662	455	SCANIA	10	1	165							16	SAE 1 1/2" 10 C	double bent (long; R=100 mm)
F	232400	3663	455	SCANIA	10	1	165							16	SAE 1 1/2" 10 C	double bent (long; R=100 mm)
G	233200	4020	233	SCANIA	10	1	165							16	SAE 1 1/2" 10 C	double bent (short; R=65 mm)
H	233210	4021	233	SCANIA	10	1	165							16	SAE 1 1/2" 10 C	double bent (short; R=65 mm)
I	235400	4040	235	SCANIA	10	1	165							16	SAE 1 1/2" 10 C	double bent (short; R=65 mm)
J	235410	4041	235	SCANIA	10	1	165							16	SAE 1 1/2" 10 C	double bent (short; R=65 mm)
K	235830	4083	235	SCANIA	10	1	165							16	SAE 1 1/2" 10 C	double bent (short; R=65 mm)
L	235840	4084	235	SCANIA	10	1	165							16	SAE 1 1/2" 10 C	double bent (short; R=65 mm)



SCANIA

SCANIA	4066	SCANIA	4067	SCANIA	2752
A		B		C	
	AYS CODE 265660 PART NUMBER 79368 AYS S-ABA CODE OEM NO 1108061		AYS CODE 265670 PART NUMBER 79369 AYS S-ABA CODE OEM NO 1108062		AYS CODE 324524 PART NUMBER 72249 AYS S-ABA CODE 803185 OEM NO 633107720
SCANIA	3226	SCANIA	4085	SCANIA	3891
D		E		F	
	AYS CODE 353261 PART NUMBER 72963 AYS S-ABA CODE 800790 OEM NO		AYS CODE 353851 PART NUMBER 72962 AYS S-ABA CODE 803075 OEM NO		AYS CODE 353910 PART NUMBER 72953 AYS S-ABA CODE 803070 OEM NO
SCANIA	4040	SCANIA	4041	SCANIA	3162
G		H		I	
	AYS CODE 367400 PART NUMBER 72958 AYS S-ABA CODE OEM NO		AYS CODE 367410 PART NUMBER 72959 AYS S-ABA CODE OEM NO		AYS CODE 390620 PART NUMBER cs AYS S-ABA CODE 801680 OEM NO
SCANIA	3162	SCANIA	2771	SCANIA	2772
J		K		L	
	AYS CODE 390621 PART NUMBER cs AYS S-ABA CODE 801685 OEM NO		AYS CODE 390710 PART NUMBER 72727 AYS S-ABA CODE OEM NO KB2585		AYS CODE 390720 PART NUMBER 72728 AYS S-ABA CODE OEM NO KB2590

	AYS CODE	CASTING	CONTROL UNIT	APPLICATION	SPLINE TEETH	NO of HOLE	H1	H2	H3	H4	H5	H6	H7	BUSHING (mm)	SPLINE TYPE	CONTROL ARM
A	265660	4066	165	SCANIA	10	1	165							16	SAE 1 1/2" 10 C	double bent (short; R=65 mm)
B	265670	4067	165	SCANIA	10	1	165							16	SAE 1 1/2" 10 C	double bent (short; R=65 mm)
C	324524	2752	424	SCANIA	10	4	203	178	152	127				14	SAE 1 1/2" 10 C	bent
D	353261	3226	453	SCANIA	10	1	165							16	SAE 1 1/2" 10 C	double bent (long; R=100 mm)
E	353851	4085	453	SCANIA	10	1	165							16	SAE 1 1/2" 10 C	double bent (long; R=100 mm)
F	353910	3891	453	SCANIA	10	2	165	140						16	SAE 1 1/2" 10 C	double bent (long; R=100 mm)
G	367400	4040	367	SCANIA	10	1	165							16	SAE 1 1/2" 10 C	double bent (short; R=65 mm)
H	367410	4041	367	SCANIA	10	1	165							16	SAE 1 1/2" 10 C	double bent (short; R=65 mm)
I	390620	3162	390	SCANIA	10	1	130							16	SAE 1 1/2" 10 C	double bent (short; R=65 mm)
J	390621	3162	390	SCANIA	10	1	145							16	SAE 1 1/2" 10 C	double bent (short; R=65 mm)
K	390710	2771	390	SCANIA	10	1	130							16	SAE 1 1/2" 10 C	double bent (short; R=65 mm)
L	390720	2772	390	SCANIA	10	1	130							16	SAE 1 1/2" 10 C	double bent (short; R=65 mm)

SCANIA	3883	SCANIA	3884	SCANIA	3883
A		B		C	
	AYS CODE 399830 PART NUMBER 72730 AYS S-ABA CODE OEM NO 4W3525		AYS CODE 399840 PART NUMBER 72729 AYS S-ABA CODE OEM NO 4W3520		AYS CODE 401830 PART NUMBER 79625 AYS S-ABA CODE OEM NO
SCANIA	3884	SCANIA	4050	SCANIA	4051
D		E		F	
	AYS CODE 401840 PART NUMBER 79453 AYS S-ABA CODE OEM NO 4W3715		AYS CODE 405500 PART NUMBER 72893 AYS S-ABA CODE 800455 OEM NO KB2605		AYS CODE 405510 PART NUMBER 72892 AYS S-ABA CODE 800460 OEM NO KB2600
SCANIA	4083	SCANIA	4084	SCANIA	4083
G		H		I	
	AYS CODE 430830 PART NUMBER 79786 AYS S-ABA CODE 801650 OEM NO 1335986		AYS CODE 430840 PART NUMBER 79787 AYS S-ABA CODE 801655 OEM NO 1335985		AYS CODE 432830 PART NUMBER 79550 AYS S-ABA CODE 801640 OEM NO 1356696
SCANIA	4084	SCANIA	2894	SCANIA	2895
J		K		L	
	AYS CODE 432840 PART NUMBER 79551 AYS S-ABA CODE 801645 OEM NO 1356695		AYS CODE 554940 PART NUMBER 72655 AYS S-ABA CODE OEM NO 4W3310		AYS CODE 554950 PART NUMBER 72656 AYS S-ABA CODE OEM NO 4W3305

	AYS CODE	CASTING	CONTROL UNIT	APPLICATION	SPLINE TEETH	NO of HOLE	H1	H2	H3	H4	H5	H6	H7	BUSHING (mm)	SPLINE TYPE	CONTROL ARM
A	399830	3883	499	SCANIA	10	1	130							16	SAE 1 1/2" 10 C	double bent (short; R=65 mm)
B	399840	3884	499	SCANIA	10	1	130							16	SAE 1 1/2" 10 C	double bent (short; R=65 mm)
C	401830	3883	501	SCANIA	10	1	130							16	SAE 1 1/2" 10 C	double bent (short; R=65 mm)
D	401840	3884	501	SCANIA	10	1	130							16	SAE 1 1/2" 10 C	double bent (short; R=65 mm)
E	405500	4050	505	SCANIA	10	1	130							16	SAE 1 1/2" 10 C	double bent (short; R=65 mm)
F	405510	4051	505	SCANIA	10	1	130							16	SAE 1 1/2" 10 C	double bent (short; R=65 mm)
G	430830	4083	730	SCANIA	10	1	165							16	SAE 1 1/2" 10 C	DOUBLE BENT (SHORT; R=65 MM)
H	430840	4084	730	SCANIA	10	1	165							16	SAE 1 1/2" 10 C	DOUBLE BENT (SHORT; R=65 MM)
I	432830	4083	732	SCANIA	10	1	165							16	SAE 1 1/2" 10 C	double bent (short; R=65 mm)
J	432840	4084	732	SCANIA	10	1	165							16	SAE 1 1/2" 10 C	double bent (short; R=65 mm)
K	554940	2894	754	SCANIA	10	1	151							12,7	SAE 1 1/2" 10 C	double bent (short; R=65 mm)
L	554950	2895	754	SCANIA	10	1	151							12,7	SAE 1 1/2" 10 C	double bent (short; R=65 mm)



SCANIA / DAF

SCANIA	2901	SCANIA	2902	SCANIA	2771
A		B		C	
	AYS CODE 556010		AYS CODE 556020		AYS CODE 558710
	PART NUMBER 72657		PART NUMBER 72658		PART NUMBER 72747
	AYS S-ABA CODE 800925		AYS S-ABA CODE 800930		AYS S-ABA CODE
	OEM NO 221733		OEM NO 221734		OEM NO 4W3250
SCANIA	2771	SCANIA	2772	SCANIA	2772
D		E		F	
	AYS CODE 558711		AYS CODE 558720		AYS CODE 558721
	PART NUMBER 72957		PART NUMBER 72746		PART NUMBER 72956
	AYS S-ABA CODE		AYS S-ABA CODE		AYS S-ABA CODE
	OEM NO		OEM NO 4W3245		OEM NO
SCANIA	3883	SCANIA	3884	SCANIA	3049
G		H		I	
	AYS CODE 560830		AYS CODE 560840		AYS CODE 578490
	PART NUMBER 72895		PART NUMBER 72894		PART NUMBER 79105
	AYS S-ABA CODE		AYS S-ABA CODE		AYS S-ABA CODE
	OEM NO 4W3720		OEM NO		OEM NO 4W3550
SCANIA	3050	DAF	3185	DAF	3186
J		K		L	
	AYS CODE 578500		AYS CODE 240101		AYS CODE 240200
	PART NUMBER 79106		PART NUMBER 72544		PART NUMBER 72527
	AYS S-ABA CODE		AYS S-ABA CODE 801755		AYS S-ABA CODE 801820
	OEM NO 4W3555		OEM NO 4W3655		OEM NO 279234











	AYS CODE	CASTING	CONTROL UNIT	APPLICATION	SPLINE TEETH	NO of HOLE	H1	H2	H3	H4	H5	H6	H7	BUSHING (mm)	SPLINE TYPE	CONTROL ARM
A	556010	2901	756	SCANIA	10	1	151							12,7	SAE 1 1/2" 10 C	double bent (short; R=65 mm)
B	556020	2902	756	SCANIA	10	1	151							12,7	SAE 1 1/2" 10 C	double bent (short; R=65 mm)
C	558710	2771	758	SCANIA	10	1	130							12,7	SAE 1 1/2" 10 C	double bent (short; R=65 mm)
D	558711	2771	758	SCANIA	10	1	130							16	SAE 1 1/2" 10 C	double bent (short; R=65 mm)
E	558720	2772	758	SCANIA	10	1	130							12,7	SAE 1 1/2" 10 C	double bent (short; R=65 mm)
F	558721	2772	758	SCANIA	10	1	130							16	SAE 1 1/2" 10 C	double bent (short; R=65 mm)
G	560830	3883	760	SCANIA	10	1	130							16	SAE 1 1/2" 10 C	double bent (short; R=65 mm)
H	560840	3884	760	SCANIA	10	1	130							16	SAE 1 1/2" 10 C	double bent (short; R=65 mm)
I	578490	3049	878	SCANIA	10	1	165							16	SAE 1 1/2" 10 C	double bent (short; R=65 mm)
J	578500	3050	878	SCANIA	10	1	165							16	SAE 1 1/2" 10 C	double bent (short; R=65 mm)
K	240101	3185	556	DAF	10	1	143							14	SAE 1 1/2" 10 C	double bent (short; R=65 mm)
L	240200	3186	556	DAF	26	1	143							14	N42x1.5x9H DIN 5480	double bent (short; R=65 mm)

DAF	3186	DAF	3185	DAF	3186
A		B		C	
	AYS CODE 240201 PART NUMBER 72545 AYS S-ABA CODE 801760 OEM NO 4W3660		AYS CODE 240300 PART NUMBER 72695 AYS S-ABA CODE 801755 OEM NO 0755247		AYS CODE 240400 PART NUMBER 72696 AYS S-ABA CODE 801760 OEM NO 0755248
DAF	3226	DAF	3226	DAF	3226
D		E		F	
	AYS CODE 240500 PART NUMBER cs AYS S-ABA CODE 800775 OEM NO		AYS CODE 240600 PART NUMBER 72540 AYS S-ABA CODE 800785 OEM NO KB2305		AYS CODE 240601 PART NUMBER 72530 AYS S-ABA CODE 800755 OEM NO KB2760
DAF	3226	DAF	3226	DAF	3226
G		H		I	
	AYS CODE 240700 PART NUMBER 72547 AYS S-ABA CODE 800780 OEM NO 4W3665		AYS CODE 240800 PART NUMBER 72309 AYS S-ABA CODE 800780 OEM NO		AYS CODE 240902 PART NUMBER 70871 AYS S-ABA CODE 800750 OEM NO 4W2005
DAF	4104	DAF	2752	DAF	2752
J		K		L	
	AYS CODE 241100 PART NUMBER 72534 AYS S-ABA CODE 802920 OEM NO KB2030		AYS CODE 241200 PART NUMBER 72529 AYS S-ABA CODE 803420 OEM NO 279244		AYS CODE 241201 PART NUMBER 72546 AYS S-ABA CODE 802930 OEM NO KB2880





	AYS CODE	CASTING	CONTROL UNIT	APPLICATION	SPLINE TEETH	NO of HOLE	H1	H2	H3	H4	H5	H6	H7	BUSHING (mm)	SPLINE TYPE	CONTROL ARM
A	240201	3186	556	DAF	10	1	143							14	SAE 1 1/2" 10 C	double bent (short; R=65 mm)
B	240300	3185	189	DAF	10	1	143							14	SAE 1 1/2" 10 C	double bent (short; R=65 mm)
C	240400	3186	189	DAF	10	1	143							14	SAE 1 1/2" 10 C	double bent (short; R=65 mm)
D	240500	3226	364	DAF	10	1	165							14	SAE 1 1/2" 10 C	double bent (long; R=100 mm)
E	240600	3226	555	DAF	10	1	165							14	SAE 1 1/2" 10 C	double bent (medium; R=78 mm)
F	240601	3226	555	DAF	10	1	140							14	SAE 1 1/2" 10 C	double bent (medium; R=78 mm)
G	240700	3226	560	DAF	10	1	165							14	SAE 1 1/2" 10 C	double bent (short; R=65 mm)
H	240800	3226	900	DAF	10	1	165							14	SAE 1 1/2" 10 C	double bent (short; R=65 mm)
I	240902	3226	908	DAF	10	1	140							14	SAE 1 1/2" 10 C	bent
J	241100	4104	555	DAF	10	1	140							14	SAE 1 1/2" 10 C	double bent (medium; R=78 mm)
K	241200	2752	557	DAF	26	1	140							x	N42x1.5x9H DIN 5480	double bent (short; R=65 mm)
L	241201	2752	557	DAF	10	1	140							x	SAE 1 1/2" 10 C	double bent (short; R=65 mm)



DAF

DAF A 	2752 AYS CODE 241300 PART NUMBER CS AYS S-ABA CODE 802960 OEM NO	DAF B 	3226 AYS CODE 241500 PART NUMBER 72541 AYS S-ABA CODE 800780 OEM NO KB2675	DAF C 	2760 AYS CODE 241600 PART NUMBER 70824 AYS S-ABA CODE 802090 OEM NO 4W2805
DAF D 	2761 AYS CODE 241700 PART NUMBER 70825 AYS S-ABA CODE 802095 OEM NO 4W2810	DAF E 	2760 AYS CODE 241800 PART NUMBER 72525 AYS S-ABA CODE 802050 OEM NO KB2115	DAF F 	2761 AYS CODE 241900 PART NUMBER 72526 AYS S-ABA CODE 802055 OEM NO KB2125
DAF G 	2760 AYS CODE 242000 PART NUMBER 72532 AYS S-ABA CODE 802200 OEM NO 0092419	DAF H 	2760 AYS CODE 242001 PART NUMBER 72523 AYS S-ABA CODE 802050 OEM NO KB2010	DAF I 	2761 AYS CODE 242100 PART NUMBER 72533 AYS S-ABA CODE 802205 OEM NO 0092420
DAF J 	2761 AYS CODE 242101 PART NUMBER 72524 AYS S-ABA CODE 802055 OEM NO KB2015	DAF K 	2985 AYS CODE 242200 PART NUMBER 72537 AYS S-ABA CODE 802590 OEM NO KB2120	DAF L 	2985 AYS CODE 242201 PART NUMBER 72543 AYS S-ABA CODE 802640 OEM NO KB2035













	AYS CODE	CASTING	CONTROL UNIT	APPLICATION	SPLINE TEETH	NO of HOLE	H1	H2	H3	H4	H5	H6	H7	BUSHING (mm)	SPLINE TYPE	CONTROL ARM
A	241300	2752	908	DAF	10	1	150							14	SAE 1 1/2" 10 C	bent
B	241500	3226	557	DAF	10	1	165							14	SAE 1 1/2" 10 C	double bent (short; R=65 mm)
C	241600	2760	419	DAF	10	1	140							14	SAE 1 1/2" 10 C	bent
D	241700	2761	419	DAF	10	1	140							14	SAE 1 1/2" 10 C	bent
E	241800	2760	555	DAF	10	1	140							14	SAE 1 1/2" 10 C	double bent (medium; R=78 mm)
F	241900	2761	555	DAF	10	1	140							14	SAE 1 1/2" 10 C	double bent (medium; R=78 mm)
G	242000	2760	558	DAF	10	1	165							14	SAE 1 1/2" 10 C	double bent (medium; R=78 mm)
H	242001	2760	558	DAF	10	1	140							14	SAE 1 1/2" 10 C	double bent (medium; R=78 mm)
I	242100	2761	558	DAF	10	1	165							14	SAE 1 1/2" 10 C	double bent (medium; R=78 mm)
J	242101	2761	558	DAF	10	1	140							14	SAE 1 1/2" 10 C	double bent (medium; R=78 mm)
K	242200	2985	557	DAF	10	1	140							14	SAE 1 1/2" 10 C	double bent (short; R=65 mm)
L	242201	2985	557	DAF	10	1	165							14	SAE 1 1/2" 10 C	double bent (short; R=65 mm)

DAF	2987	2987	2987	2985
A		AYS CODE 242300	AYS CODE 242301	AYS CODE 242400
	PART NUMBER 72536	PART NUMBER 72542	PART NUMBER 72542	PART NUMBER 72311
	AYS S-ABA CODE 802595	AYS S-ABA CODE 802645	AYS S-ABA CODE 802645	AYS S-ABA CODE 802590
	OEM NO KB2110	OEM NO KB2105	OEM NO KB2105	OEM NO KB2105
DAF	2987	2987	4042	4042
D		AYS CODE 242500	AYS CODE 242600	AYS CODE 242604
	PART NUMBER 72310	PART NUMBER 72538	PART NUMBER 72538	PART NUMBER 79179
	AYS S-ABA CODE 802595	AYS S-ABA CODE 801590	AYS S-ABA CODE 801590	AYS S-ABA CODE 801580
	OEM NO KB2110	OEM NO KB2020	OEM NO KB2020	OEM NO 1309074
DAF	4043	4043	4043	4042
G		AYS CODE 242700	AYS CODE 242705	AYS CODE 242800
	PART NUMBER 72539	PART NUMBER 79180	PART NUMBER 79180	PART NUMBER 72302
	AYS S-ABA CODE 801595	AYS S-ABA CODE 801585	AYS S-ABA CODE 801585	AYS S-ABA CODE 801590
	OEM NO KB2025	OEM NO 1309075	OEM NO 1309075	OEM NO 1309075
DAF	4043	4043	3226	2752
J		AYS CODE 242900	AYS CODE 243000	AYS CODE 243100
	PART NUMBER 72301	PART NUMBER 72535	PART NUMBER 72535	PART NUMBER 72531
	AYS S-ABA CODE 801595	AYS S-ABA CODE 800755	AYS S-ABA CODE 800755	AYS S-ABA CODE 802930
	OEM NO KB2110	OEM NO KB2515	OEM NO KB2515	OEM NO 281095













	AYS CODE	CASTING	CONTROL UNIT	APPLICATION	SPLINE TEETH	NO of HOLE	H1	H2	H3	H4	H5	H6	H7	BUSHING (mm)	SPLINE TYPE	CONTROL ARM
A	242300	2987	557	DAF	10	1	140							14	SAE 1 1/2" 10 C	double bent (short; R=65 mm)
B	242301	2987	557	DAF	10	1	165							14	SAE 1 1/2" 10 C	double bent (short; R=65 mm)
C	242400	2985	900	DAF	10	1	165							14	SAE 1 1/2" 10 C	double bent (short; R=65 mm)
D	242500	2987	900	DAF	10	1	165							14	SAE 1 1/2" 10 C	double bent (short; R=65 mm)
E	242600	4042	560	DAF	10	1	165							14	SAE 1 1/2" 10 C	double bent (short; R=65 mm)
F	242604	4042	560	DAF	10	1	145							14	SAE 1 1/2" 10 C	double bent (short; R=65 mm)
G	242700	4043	560	DAF	10	1	165							14	SAE 1 1/2" 10 C	double bent (short; R=65 mm)
H	242705	4043	560	DAF	10	1	145							14	SAE 1 1/2" 10 C	double bent (short; R=65 mm)
I	242800	4042	784	DAF	10	1	165							14	SAE 1 1/2" 10 C	double bent (short; R=65 mm)
J	242900	4043	784	DAF	10	1	165							14	SAE 1 1/2" 10 C	double bent (short; R=65 mm)
K	243000	3226	558	DAF	10	1	140							14	SAE 1 1/2" 10 C	double bent (medium; R=78 mm)
L	243100	2752	559	DAF	10	1	140							x	SAE 1 1/2" 10 C	double bent (short; R=65 mm)

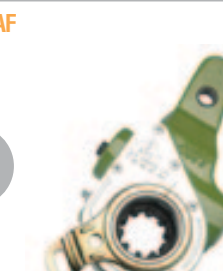

DAF

DAF	2985	DAF	2987	DAF	3068
A		B		C	
	AYS CODE 243200 PART NUMBER 72680 AYS S-ABA CODE 802590 OEM NO 4W3760		AYS CODE 243300 PART NUMBER 72679 AYS S-ABA CODE 802595 OEM NO 4W3790		AYS CODE 243400 PART NUMBER 72833 AYS S-ABA CODE 801280 OEM NO 4W3975
DAF	3069	DAF	4104	DAF	2760
D		E		F	
	AYS CODE 243500 PART NUMBER 72834 AYS S-ABA CODE 801285 OEM NO 4W3980		AYS CODE 319040 PART NUMBER 70823 AYS S-ABA CODE 802915 OEM NO 4W2000		AYS CODE 327602 PART NUMBER 72815 AYS S-ABA CODE 802080 OEM NO R9640/F
DAF	2761	DAF	2760	DAF	2761
G		H		I	
	AYS CODE 327612 PART NUMBER 72816 AYS S-ABA CODE 802085 OEM NO R9641/F		AYS CODE 362600 PART NUMBER 72150 AYS S-ABA CODE 802190 OEM NO 7955/F		AYS CODE 362610 PART NUMBER 72151 AYS S-ABA CODE 802195 OEM NO 7956/F
DAF	3226	DAF	4077	DAF	4078
J		K		L	
	AYS CODE 364260 PART NUMBER 72558 AYS S-ABA CODE 800765 OEM NO 537537		AYS CODE 418770 PART NUMBER 72886 AYS S-ABA CODE OEM NO 72886G		AYS CODE 418780 PART NUMBER 72887 AYS S-ABA CODE OEM NO 4W2730

	AYS CODE	CASTING	CONTROL UNIT	APPLICATION	SPLINE TEETH	NO of HOLE	H1	H2	H3	H4	H5	H6	H7	BUSHING (mm)	SPLINE TYPE	CONTROL ARM
A	243200	2985	608	DAF	10	1	140							14	SAE 1 1/2" 10 C	double bent (short; R=65 mm)
B	243300	2987	608	DAF	10	1	140							14	SAE 1 1/2" 10 C	double bent (short; R=65 mm)
C	243400	3068	558	DAF	10	1	165							14	SAE 1 1/2" 10 C	double bent (medium; R=78 mm)
D	243500	3069	558	DAF	10	1	165							14	SAE 1 1/2" 10 C	double bent (medium; R=78 mm)
E	319040	4104	419	DAF	10	1	140							14	SAE 1 1/2" 10 C	bent
F	327602	2760	427	DAF	10	1	140							14	SAE 1 1/2" 10 C	bent
G	327612	2761	427	DAF	10	1	140							14	SAE 1 1/2" 10 C	bent
H	362600	2760	262	DAF	10	1	165							14	SAE 1 1/2" 10 C	double bent (medium; R=78 mm)
I	362610	2761	262	DAF	10	1	165							14	SAE 1 1/2" 10 C	double bent (medium; R=78 mm)
J	364260	3226	364	DAF	10	1	140							14	SAE 1 1/2" 10 C	double bent (long; R=100 mm)
K	418770	4077	618	DAF	10	1	145							14	SAE 1 1/2" 10 C	double bent (medium; R=78 mm)
L	418780	4078	618	DAF	10	1	145							14	SAE 1 1/2" 10 C	double bent (medium; R=78 mm)

DAF	3049	DAF	3050	DAF	4085
A		B		C	
	AYS CODE 421490		AYS CODE 421500		AYS CODE 423850
	PART NUMBER 79577		PART NUMBER 79578		PART NUMBER 79371
	AYS S-ABA CODE		AYS S-ABA CODE		AYS S-ABA CODE 803290
	OEM NO 1372187		OEM NO 1372188		OEM NO 3263623
DAF	4070	DAF	4071	DAF	2765
D		E		F	
	AYS CODE 435700		AYS CODE 435710		AYS CODE 455650
	PART NUMBER 79024		PART NUMBER 79025		PART NUMBER 72608
	AYS S-ABA CODE		AYS S-ABA CODE		AYS S-ABA CODE
	OEM NO 4W3425		OEM NO 4W3430		OEM NO KB2400
DAF	2766	DAF	4077	DAF	4077
G		H		I	
	AYS CODE 455660		AYS CODE 455770		AYS CODE 455771
	PART NUMBER 72609		PART NUMBER 72704		PART NUMBER 72794
	AYS S-ABA CODE		AYS S-ABA CODE		AYS S-ABA CODE
	OEM NO KB2425		OEM NO 4W3700		OEM NO 1234403
DAF	4078	DAF	4078	DAF	4085
J		K		L	
	AYS CODE 455780		AYS CODE 455781		AYS CODE 457852
	PART NUMBER 72705		PART NUMBER 72795		PART NUMBER 72553
	AYS S-ABA CODE		AYS S-ABA CODE		AYS S-ABA CODE 803085
	OEM NO 4W3705		OEM NO 1234404		OEM NO 8947

	AYS CODE	CASTING	CONTROL UNIT	APPLICATION	SPLINE TEETH	NO of HOLE	H1	H2	H3	H4	H5	H6	H7	BUSHING (mm)	SPLINE TYPE	CONTROL ARM
A	421490	3049	321	DAF	10	1	165							14	SAE 1 1/2" 10 C	double bent (medium; R=78 mm)
B	421500	3050	321	DAF	10	1	165							14	SAE 1 1/2" 10 C	double bent (medium; R=78 mm)
C	423850	4085	723	DAF	19	1	152							14	A38x34 DIN 5482	double bent (short; R=65 mm)
D	435700	4070	735	DAF	10	1	165							14	SAE 1 1/2" 10 C	double bent (medium; R=78 mm)
E	435710	4071	735	DAF	10	1	165							14	SAE 1 1/2" 10 C	double bent (medium; R=78 mm)
F	455650	2765	555	DAF	10	1	140							14	SAE 1 1/2" 10 C	double bent (medium; R=78 mm)
G	455660	2766	555	DAF	10	1	140							14	SAE 1 1/2" 10 C	double bent (medium; R=78 mm)
H	455770	4077	555	DAF	10	1	145							14	SAE 1 1/2" 10 C	double bent (medium; R=78 mm)
I	455771	4077	555	DAF	10	1	165							14	SAE 1 1/2" 10 C	double bent (medium; R=78 mm)
J	455780	4078	555	DAF	10	1	145							14	SAE 1 1/2" 10 C	double bent (medium; R=78 mm)
K	455781	4078	555	DAF	10	1	165							14	SAE 1 1/2" 10 C	double bent (medium; R=78 mm)
L	457852	4085	557	DAF	10	1	165							x	SAE 1 1/2" 10 C	double bent (short; R=65 mm)





ABA
Automatic Brake Adjuster / Otomatik Fren Ayar Kolu.
S-ABA
(Self Setting) Automatic Brake Adjuster / Tam Otomatik Fren Ayar Kolu.

* CS > Customer Specific / Özel İmalat











PRODUCT PICTURES ARE TAKEN OF REFERENCE FOR CASTING BODIES. ALSO PLEASE IGNORE CONTROL UNIT & ITS POSITION. ÜRÜN FOTOĞRAFLARI GÖVDELER REFERANS ALINARAK YERLEŞTİRİLMİŞTİR. KİLİT VE KİLİT AÇILARINI DİKKATE ALMAYINIZ.

ALL ORIGINAL NUMBERS, MARKS AND MODELS FROM VEHICLE MANUFACTURERS LISTED IN THIS CATALOGUE ARE FOR COMPARISON PURPOSES ONLY AND MAY NOT BE USED IN INVOICES TO VEHICLE OWNERS OR RESELLERS. / ORJINAL ÜRÜN NUMARALARI MÜŞTERİYİ BİLGİLENDİRME VE ÜRÜNE REFERANS AMAÇLI KULLANILMIŞTIR.

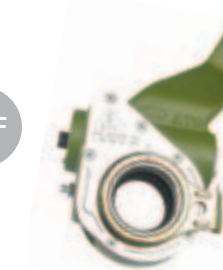
DAF / SISU

DAF	4104	A		AYS CODE 458040 PART NUMBER 72550 AYS S-ABA CODE 802920 OEM NO 1267843	DAF	3865	B		AYS CODE 461650 PART NUMBER 72548 AYS S-ABA CODE OEM NO KB2395	DAF	2760	C		AYS CODE 471601 PART NUMBER 72586 AYS S-ABA CODE 802050 OEM NO 4W3505
DAF	2761	D		AYS CODE 471611 PART NUMBER 72587 AYS S-ABA CODE 802055 OEM NO 0538471	DAF	2894	E		AYS CODE 502940 PART NUMBER 70872 AYS S-ABA CODE OEM NO 	DAF	3049	F		AYS CODE 555490 PART NUMBER 79167 AYS S-ABA CODE OEM NO 1311809
DAF	3050	G		AYS CODE 555500 PART NUMBER 79168 AYS S-ABA CODE OEM NO 1311810	DAF	2760	H		AYS CODE 583600 PART NUMBER 10868 AYS S-ABA CODE 802090 OEM NO 9007808	DAF	2761	I		AYS CODE 583610 PART NUMBER 10869 AYS S-ABA CODE 802095 OEM NO 9007807
DAF	3226	J		AYS CODE 584260 PART NUMBER 72327 AYS S-ABA CODE 800780 OEM NO 	SISU	3717	K		AYS CODE 203170 PART NUMBER 79407 AYS S-ABA CODE 801935 OEM NO 5465303111	SISU	3718	L		AYS CODE 203180 PART NUMBER 79408 AYS S-ABA CODE 801940 OEM NO 5465303121

	AYS CODE	CASTING	CONTROL UNIT	APPLICATION	SPLINE TEETH	NO of HOLE	H1	H2	H3	H4	H5	H6	H7	BUSHING (mm)	SPLINE TYPE	CONTROL ARM
A	458040	4104	558	DAF	10	1	140							14	SAE 1 1/2" 10 C	double bent (medium; R=78 mm)
B	461650	3865	561	DAF	10	1	140							14	SAE 1 1/2" 10 C	double bent (short; R=65 mm)
C	471601	2760	571	DAF	10	1	140							14	SAE 1 1/2" 10 C	double bent (medium; R=78 mm)
D	471611	2761	571	DAF	10	1	140							14	SAE 1 1/2" 10 C	double bent (medium; R=78 mm)
E	502940	2894	902	DAF	10	1	143							14	SAE 1 1/2" 10 C	bent
F	555490	3049	855	DAF	10	1	165							14	SAE 1 1/2" 10 C	double bent (short; R=65 mm)
G	555500	3050	855	DAF	10	1	165							14	SAE 1 1/2" 10 C	double bent (short; R=65 mm)
H	583600	2760	983	DAF	10	1	140							14	SAE 1 1/2" 10 C	bent
I	583610	2761	983	DAF	10	1	140							14	SAE 1 1/2" 10 C	bent
J	584260	3226	784	DAF	10	1	165							14	SAE 1 1/2" 10 C	double bent (short; R=65 mm)
K	203170	3717	203	SISU	26	1	165							14	N42x1.5x9H DIN 5480	double bent (short; R=65 mm)
L	203180	3718	203	SISU	26	1	165							14	N42x1.5x9H DIN 5480	double bent (short; R=65 mm)

SISU	3049	SISU	3050	SISU	4079
A		B		C	
	AYS CODE 204490 PART NUMBER 79662 AYS S-ABA CODE OEM NO 5465303411		AYS CODE 204500 PART NUMBER 79663 AYS S-ABA CODE OEM NO 5465303421		AYS CODE 204790 PART NUMBER 79398 AYS S-ABA CODE OEM NO 5465301911
SISU	4080	SISU	3717	SISU	3718
D		E		F	
	AYS CODE 204800 PART NUMBER 79399 AYS S-ABA CODE OEM NO 5465301921		AYS CODE 299170 PART NUMBER 79394 AYS S-ABA CODE 801915 OEM NO 665465303211		AYS CODE 299180 PART NUMBER 79395 AYS S-ABA CODE 801920 OEM NO 665465303221
SISU	4085	SISU	4085	SISU	4085
G		H		I	
	AYS CODE 378850 PART NUMBER 79501 AYS S-ABA CODE 803065 OEM NO 5465303311		AYS CODE 385850 PART NUMBER 72428 AYS S-ABA CODE 802935 OEM NO 661465300611		AYS CODE 385851 PART NUMBER 79372 AYS S-ABA CODE 802635 OEM NO 5465301811
SISU	4086	SISU	4085	SISU	3068
J		K		L	
	AYS CODE 385860 PART NUMBER 79643 AYS S-ABA CODE 803645 OEM NO 5465303611		AYS CODE 386850 PART NUMBER 72429 AYS S-ABA CODE 802935 OEM NO 661465300811		AYS CODE 407680 PART NUMBER 79639 AYS S-ABA CODE 801270 OEM NO 5465303511

	AYS CODE	CASTING	CONTROL UNIT	APPLICATION	SPLINE TEETH	NO of HOLE	H1	H2	H3	H4	H5	H6	H7	BUSHING (mm)	SPLINE TYPE	CONTROL ARM
A	204490	3049	204	SISU	26	1	165							14	N42x1.5x12H DIN 5480	double bent (short; R=65 mm)
B	204500	3050	204	SISU	26	1	165							14	N42x1.5x12H DIN 5480	double bent (short; R=65 mm)
C	204790	4079	204	SISU	26	1	180							14	N42x1.5x9H DIN 5480	double bent (short; R=65 mm)
D	204800	4080	204	SISU	26	1	180							14	N42x1.5x9H DIN 5480	double bent (short; R=65 mm)
E	299170	3717	199	SISU	10	1	165							14	SAE 1 1/2" 10 C	double bent (long; R=100 mm)
F	299180	3718	199	SISU	10	1	165							14	SAE 1 1/2" 10 C	double bent (long; R=100 mm)
G	378850	4085	378	SISU	10	1	165							14	SAE 1 1/2" 10 C	double bent (short; R=65 mm)
H	385850	4085	385	SISU	10	1	145							14	SAE 1 1/2" 10 C	double bent (short; R=65 mm)
I	385851	4085	385	SISU	26	1	145							14	N42x1.5x9H DIN 5480	double bent (short; R=65 mm)
J	385860	4086	385	SISU	10	5	215	181	153	129	105			14	SAE 1 1/2" 10 C	double bent (short; R=65 mm)
K	386850	4085	386	SISU	10	1	145							14	SAE 1 1/2" 10 C	double bent (short; R=65 mm)
L	407680	3068	507	SISU	10	1	165							14	SAE 1 1/2" 10 C	double bent (long; R=100 mm)















ABA
Automatic Brake Adjuster / Otomatik Fren Ayar Kolu.
S-ABA
(Self Setting) Automatic Brake Adjuster / Tam Otomatik Fren Ayar Kolu.

* CS > Customer Specific / Özel İmalat







PRODUCT PICTURES ARE TAKEN OF REFERENCE FOR CASTING BODIES. ALSO PLEASE IGNORE CONTROL UNIT & ITS POSITION. ÜRÜN FOTOĞRAFLARI GÖVDELER REFERANS ALINARAK YERLEŞTİRİLMİŞTİR. KİLİT VE KİLİT AÇILARINI DİKKATE ALMAYINIZ.

ALL ORIGINAL NUMBERS, MARKS AND MODELS FROM VEHICLE MANUFACTURERS LISTED IN THIS CATALOGUE ARE FOR COMPARISON PURPOSES ONLY AND MAY NOT BE USED IN INVOICES TO VEHICLE OWNERS OR RESELLERS. / ORJINAL ÜRÜN NUMARALARI MÜŞTERİYİ BİLGİLENDİRME VE ÜRÜNE REFERANS AMAÇLI KULLANILMIŞTIR.

SISU / VOLVO

SISU	3069	SISU	3185	SISU	3186
A	 AYS CODE 407690 PART NUMBER 79640 AYS S-ABA CODE 801275 OEM NO 5465303521	B	 AYS CODE 407850 PART NUMBER 72521 AYS S-ABA CODE 801745 OEM NO 1465300911	C	 AYS CODE 407860 PART NUMBER 72522 AYS S-ABA CODE 801750 OEM NO 1465300921
SISU	4085	SISU	3185	SISU	3186
D	 AYS CODE 423850 PART NUMBER 79371 AYS S-ABA CODE 803290 OEM NO 3263623	E	 AYS CODE 436850 PART NUMBER 79002 AYS S-ABA CODE 801825 OEM NO 1465301321	F	 AYS CODE 436860 PART NUMBER 79003 AYS S-ABA CODE 801830 OEM NO 1465301311
SISU	4104	SISU	3068	SISU	3069
G	 AYS CODE 470040 PART NUMBER 70851 AYS S-ABA CODE 802890 OEM NO 1465300151	H	 AYS CODE 485680 PART NUMBER 79068 AYS S-ABA CODE 801210 OEM NO	I	 AYS CODE 485690 PART NUMBER 79069 AYS S-ABA CODE 801215 OEM NO
SISU	2897	VOLVO	3860	VOLVO	3860
J	 AYS CODE 567970 PART NUMBER 70852 AYS S-ABA CODE OEM NO 1465300161	K	 AYS CODE 260100 PART NUMBER 72724 AYS S-ABA CODE 802490 OEM NO KB2290	L	 AYS CODE 260101 PART NUMBER 72783 AYS S-ABA CODE 802520 OEM NO KB2300

	AYS CODE	CASTING	CONTROL UNIT	APPLICATION	SPLINE TEETH	NO of HOLE	H1	H2	H3	H4	H5	H6	H7	BUSHING (mm)	SPLINE TYPE	CONTROL ARM
A	407690	3069	507	SISU	10	1	165							14	SAE 1 1/2" 10 C	double bent (long; R=100 mm)
B	407850	3185	507	SISU	10	1	145							14	SAE 1 1/2" 10 C	double bent (long; R=100 mm)
C	407860	3186	507	SISU	10	1	145							14	SAE 1 1/2" 10 C	double bent (long; R=100 mm)
D	423850	4085	723	SISU	19	1	152							14	A38x34 DIN 5482	double bent (short; R=65 mm)
E	436850	3185	736	SISU	26	1	145							14	N42x1.5x9H DIN 5480	double bent (short; R=65 mm)
F	436860	3186	736	SISU	26	1	145							14	N42x1.5x9H DIN 5480	double bent (short; R=65 mm)
G	470040	4104	870	SISU	10	1	140							12,7	SAE 1 1/2" 10 C	double bent (short; R=65 mm)
H	485680	3068	385	SISU	10	1	145							14	SAE 1 1/2" 10 C	double bent (short; R=65 mm)
I	485690	3069	385	SISU	10	1	145							14	SAE 1 1/2" 10 C	double bent (short; R=65 mm)
J	567970	2897	867	SISU	10	1	178							16	SAE 1 1/2" 10 C	double bent (short; R=65 mm)
K	260100	3860	448	VOLVO	10	1	134							12,7	SAE 1 1/2" 10 C	bent
L	260101	3860	448	VOLVO	10	1	145							12,7	SAE 1 1/2" 10 C	bent

VOLVO	3861	A		AYS CODE 260200 PART NUMBER 72723 AYS S-ABA CODE 802495 OEM NO KB2285
VOLVO	3861	B		AYS CODE 260201 PART NUMBER 72782 AYS S-ABA CODE 802525 OEM NO KB2280
VOLVO	4104	C		AYS CODE 260300 PART NUMBER 72725 AYS S-ABA CODE 802840 OEM NO 4W3710
VOLVO	2752	D		AYS CODE 260400 PART NUMBER 72905 AYS S-ABA CODE 802840 OEM NO 1581466
VOLVO	2752	E		AYS CODE 260600 PART NUMBER cs AYS S-ABA CODE 802960 OEM NO
VOLVO	2752	F		AYS CODE 260700 PART NUMBER cs AYS S-ABA CODE 802970 OEM NO
VOLVO	4085	G		AYS CODE 260800 PART NUMBER 79178 AYS S-ABA CODE 803070 OEM NO 1586194
VOLVO	4085	H		AYS CODE 261000 PART NUMBER 72909 AYS S-ABA CODE 803080 OEM NO 1590239
VOLVO	4104	I		AYS CODE 261100 PART NUMBER 72678 AYS S-ABA CODE 802880 OEM NO KB2275
VOLVO	4085	J		AYS CODE 261200 PART NUMBER 72726 AYS S-ABA CODE 802980 OEM NO KB2295
VOLVO	2985	K		AYS CODE 261300 PART NUMBER 72669 AYS S-ABA CODE 802610 OEM NO KB2535
VOLVO	2985	L		AYS CODE 261301 PART NUMBER 72671 AYS S-ABA CODE 802620 OEM NO KB2545













	AYS CODE	CASTING	CONTROL UNIT	APPLICATION	SPLINE TEETH	NO of HOLE	H1	H2	H3	H4	H5	H6	H7	BUSHING (mm)	SPLINE TYPE	CONTROL ARM
A	260200	3861	448	VOLVO	10	1	134							12,7	SAE 1 1/2" 10 C	bent
B	260201	3861	448	VOLVO	10	1	145							12,7	SAE 1 1/2" 10 C	bent
C	260300	4104	402	VOLVO	10	1	127							12,7	SAE 1 1/2" 10 C	bent
D	260400	2752	404	VOLVO	10	1	127							12,7	SAE 1 1/2" 10 C	bent
E	260600	2752	444	VOLVO	10	1	150							14	SAE 1 1/2" 10 C	bent
F	260700	2752	448	VOLVO	10	1	150							14	SAE 1 1/2" 10 C	bent
G	260800	4085	729	VOLVO	10	2	165	140						16	SAE 1 1/2" 10 C	double bent (long; R=100 mm)
H	261000	4085	908	VOLVO	10	1	165							16	SAE 1 1/2" 10 C	bent
I	261100	4104	472	VOLVO	10	1	140							12,7	SAE 1 1/2" 10 C	double bent (long; R=100 mm)
J	261200	4085	472	VOLVO	10	1	152							12,7	SAE 1 1/2" 10 C	double bent (long; R=100 mm)
K	261300	2985	444	VOLVO	10	1	151							12,7	SAE 1 1/2" 10 C	bent
L	261301	2985	444	VOLVO	10	1	165							12,7	SAE 1 1/2" 10 C	bent



VOLVO

VOLVO	2987	VOLVO	2987	VOLVO	2752
A		B		C	
	AYS CODE 261400 PART NUMBER 72668 AYS S-ABA CODE 802615 OEM NO KB2530		AYS CODE 261401 PART NUMBER 72670 AYS S-ABA CODE 802625 OEM NO KB2540		AYS CODE 261500 PART NUMBER 70946 AYS S-ABA CODE 802915 OEM NO 1587482
VOLVO	2752	VOLVO	2985	VOLVO	2985
D		E		F	
	AYS CODE 261600 PART NUMBER 72517 AYS S-ABA CODE 802940 OEM NO 11049395		AYS CODE 261700 PART NUMBER 70832 AYS S-ABA CODE 802600 OEM NO KB2450		AYS CODE 261700 PART NUMBER 70832 AYS S-ABA CODE 802600 OEM NO KB2450
VOLVO	2987	VOLVO	2987	VOLVO	3704
G		H		I	
	AYS CODE 261710 PART NUMBER 70833 AYS S-ABA CODE 802605 OEM NO KB2455		AYS CODE 261800 PART NUMBER cs AYS S-ABA CODE 802630 OEM NO		AYS CODE 281040 PART NUMBER 79677 AYS S-ABA CODE 801865 OEM NO 9524585
VOLVO	3705	VOLVO	2753	VOLVO	2754
J		K		L	
	AYS CODE 281050 PART NUMBER 79678 AYS S-ABA CODE 801870 OEM NO 9524586		AYS CODE 302530 PART NUMBER 72675 AYS S-ABA CODE OEM NO KB2560		AYS CODE 302540 PART NUMBER 72674 AYS S-ABA CODE OEM NO KB2555













	AYS CODE	CASTING	CONTROL UNIT	APPLICATION	SPLINE TEETH	NO of HOLE	H1	H2	H3	H4	H5	H6	H7	BUSHING (mm)	SPLINE TYPE	CONTROL ARM
A	261400	2987	444	VOLVO	10	1	151							12,7	SAE 1 1/2" 10 C	bent
B	261401	2987	444	VOLVO	10	1	165							12,7	SAE 1 1/2" 10 C	bent
C	261500	2752	958	VOLVO	10	1	140							12,7	SAE 1 1/2" 10 C	bent
D	261600	2752	284	VOLVO	10	1	145							12,7	SAE 1 1/2" 10 C	bent
E	261700	2985	451	VOLVO	10	1	147							12,7	SAE 1 1/2" 10 C	double bent (long; R=100 mm)
F	261700	2985	451	VOLVO	10	1	147							12,7	SAE 1 1/2" 10 C	double bent (long; R=100 mm)
G	261710	2987	451	VOLVO	10	1	147							12,7	SAE 1 1/2" 10 C	double bent (long; R=100 mm)
H	261800	2987	451	VOLVO	10	1	165							14	SAE 1 1/2" 10 C	double bent (long; R=100 mm)
I	281040	3704	181	VOLVO	10	1	165							12,7	SAE 1 1/2" 10 C	double bent (long; R=100 mm)
J	281050	3705	181	VOLVO	10	1	165							12,7	SAE 1 1/2" 10 C	double bent (long; R=100 mm)
K	302530	2753	402	VOLVO	10	1	140							12,7	SAE 1 1/2" 10 C	bent
L	302540	2754	402	VOLVO	10	1	140							12,7	SAE 1 1/2" 10 C	bent

VOLVO	2765	A		AYS CODE 302650 PART NUMBER 72673 AYS S-ABA CODE OEM NO KB2550
VOLVO	2765	B		AYS CODE 302651 PART NUMBER 72718 AYS S-ABA CODE OEM NO KB2580
VOLVO	2765	C		AYS CODE 302652 PART NUMBER 72907 AYS S-ABA CODE OEM NO KB2690
VOLVO	2766	D		AYS CODE 302660 PART NUMBER 72672 AYS S-ABA CODE OEM NO KB2695
VOLVO	2766	E		AYS CODE 302661 PART NUMBER 72717 AYS S-ABA CODE OEM NO KB2575
VOLVO	2766	F		AYS CODE 302662 PART NUMBER 72906 AYS S-ABA CODE OEM NO KB2685
VOLVO	2765	G		AYS CODE 304650 PART NUMBER 72898 AYS S-ABA CODE OEM NO
VOLVO	2765	H		AYS CODE 304651 PART NUMBER 72901 AYS S-ABA CODE OEM NO 1581472
VOLVO	2766	I		AYS CODE 304660 PART NUMBER 72897 AYS S-ABA CODE OEM NO
VOLVO	2766	J		AYS CODE 304661 PART NUMBER 72902 AYS S-ABA CODE OEM NO 1581471
VOLVO	4087	K		AYS CODE 306870 PART NUMBER 79359 AYS S-ABA CODE 800675 OEM NO 9524856
VOLVO	4088	L		AYS CODE 306880 PART NUMBER 79360 AYS S-ABA CODE 800680 OEM NO 9524857











	AYS CODE	CASTING	CONTROL UNIT	APPLICATION	SPLINE TEETH	NO of HOLE	H1	H2	H3	H4	H5	H6	H7	BUSHING (mm)	SPLINE TYPE	CONTROL ARM
A	302650	2765	402	VOLVO	10	1	140							12,7	SAE 1 1/2" 10 C	bent
B	302651	2765	402	VOLVO	10	1	127							12,7	SAE 1 1/2" 10 C	bent
C	302652	2765	402	VOLVO	10	1	140							12,7	SAE 1 1/2" 10 C	bent
D	302660	2766	402	VOLVO	10	1	140							12,7	SAE 1 1/2" 10 C	bent
E	302661	2766	402	VOLVO	10	1	127							12,7	SAE 1 1/2" 10 C	bent
F	302662	2766	402	VOLVO	10	1	140							12,7	SAE 1 1/2" 10 C	bent
G	304650	2765	404	VOLVO	10	1	127							12,7	SAE 1 1/2" 10 C	bent
H	304651	2765	404	VOLVO	10	1	140							12,7	SAE 1 1/2" 10 C	bent
I	304660	2766	404	VOLVO	10	1	127							12,7	SAE 1 1/2" 10 C	bent
J	304661	2766	404	VOLVO	10	1	140							12,7	SAE 1 1/2" 10 C	bent
K	306870	4087	306	VOLVO	10	1	145							12,7	SAE 1 1/2" 10 C	double bent (long; R=100 mm)
L	306880	4088	306	VOLVO	10	1	145							12,7	SAE 1 1/2" 10 C	double bent (long; R=100 mm)



VOLVO

VOLVO	3226	VOLVO	4087	VOLVO	4088
A		B		C	
	AYS CODE 308260 PART NUMBER 79724 AYS S-ABA CODE 800715 OEM NO 3177014		AYS CODE 309870 PART NUMBER 79713 AYS S-ABA CODE 800675 OEM NO 3193402		AYS CODE 309880 PART NUMBER 79714 AYS S-ABA CODE 800680 OEM NO 3193403
VOLVO	3068	VOLVO	3069	VOLVO	2765
D		E		F	
	AYS CODE 311680 PART NUMBER 79641 AYS S-ABA CODE 801320 OEM NO 3136426		AYS CODE 311690 PART NUMBER 79642 AYS S-ABA CODE 801325 OEM NO 3136427		AYS CODE 312650 PART NUMBER 72916 AYS S-ABA CODE OEM NO KB2665
VOLVO	2766	VOLVO	2753	VOLVO	2754
G		H		I	
	AYS CODE 312660 PART NUMBER 72915 AYS S-ABA CODE OEM NO KB2660		AYS CODE 319530 PART NUMBER 72720 AYS S-ABA CODE OEM NO 4W3210		AYS CODE 319540 PART NUMBER 72719 AYS S-ABA CODE OEM NO KB2900
VOLVO	2765	VOLVO	2766	VOLVO	4038
J		K		L	
	AYS CODE 347650 PART NUMBER 72714 AYS S-ABA CODE OEM NO 1134298		AYS CODE 347660 PART NUMBER 72713 AYS S-ABA CODE OEM NO 1134297		AYS CODE 348380 PART NUMBER 72785 AYS S-ABA CODE OEM NO 4W3135

	AYS CODE	CASTING	CONTROL UNIT	APPLICATION	SPLINE TEETH	NO of HOLE	H1	H2	H3	H4	H5	H6	H7	BUSHING (mm)	SPLINE TYPE	CONTROL ARM
A	308260	3226	308	VOLVO	10	1	125							12,7	SAE 1 1/2" 10 C	bent
B	309870	4087	309	VOLVO	10	1	145							12,7	SAE 1 1/2" 10 C	double bent (long; R=100 mm)
C	309880	4088	309	VOLVO	10	1	145							12,7	SAE 1 1/2" 10 C	double bent (long; R=100 mm)
D	311680	3068	411	VOLVO	10	1	185							12,7	SAE 1 1/2" 10 C	bent
E	311690	3069	411	VOLVO	10	1	185							12,7	SAE 1 1/2" 10 C	bent
F	312650	2765	412	VOLVO	10	1	140							12,7	SAE 1 1/2" 10 C	bent
G	312660	2766	412	VOLVO	10	1	140							12,7	SAE 1 1/2" 10 C	bent
H	319530	2753	419	VOLVO	10	1	159							12,7	SAE 1 1/2" 10 C	bent
I	319540	2754	419	VOLVO	10	1	159							12,7	SAE 1 1/2" 10 C	bent
J	347650	2765	447	VOLVO	10	1	127							12,7	SAE 1 1/2" 10 C	bent
K	347660	2766	447	VOLVO	10	1	127							12,7	SAE 1 1/2" 10 C	bent
L	348380	4038	448	VOLVO	10	1	165							12,7	SAE 1 1/2" 10 C	bent

VOLVO	4039	VOLVO	2760	VOLVO	2761
A		B		C	
	AYS CODE 348390		AYS CODE 356600		AYS CODE 356610
	PART NUMBER 72784		PART NUMBER 70977		PART NUMBER 70978
	AYS S-ABA CODE		AYS S-ABA CODE 802140		AYS S-ABA CODE 802145
	OEM NO 4W3140		OEM NO 4W2485		OEM NO 4W2490
VOLVO	4076	VOLVO	3226	VOLVO	4104
D		E		F	
	AYS CODE 361760		AYS CODE 367260		AYS CODE 384040
	PART NUMBER 79160		PART NUMBER 79428		PART NUMBER 72085
	AYS S-ABA CODE 800070		AYS S-ABA CODE 800740		AYS S-ABA CODE 802760
	OEM NO MAS9289		OEM NO 8196083		OEM NO 4W3500
VOLVO	4085	VOLVO	2760	VOLVO	2760
G		H		I	
	AYS CODE 414850		AYS CODE 507600		AYS CODE 507602
	PART NUMBER 70957		PART NUMBER 70641		PART NUMBER 72912
	AYS S-ABA CODE 803015		AYS S-ABA CODE 802320		AYS S-ABA CODE 802070
	OEM NO 4880708		OEM NO 1581479		OEM NO 1581476
VOLVO	2760	VOLVO	2761	VOLVO	2761
J		K		L	
	AYS CODE 507603		AYS CODE 507610		AYS CODE 507612
	PART NUMBER 72914		PART NUMBER 70642		PART NUMBER 72904
	AYS S-ABA CODE 802220		AYS S-ABA CODE 802325		AYS S-ABA CODE 802220
	OEM NO 1581491		OEM NO 1581478		OEM NO 1581490

	AYS CODE	CASTING	CONTROL UNIT	APPLICATION	SPLINE TEETH	NO of HOLE	H1	H2	H3	H4	H5	H6	H7	BUSHING (mm)	SPLINE TYPE	CONTROL ARM
A	348390	4039	448	VOLVO	10	1	165							12,7	SAE 1 1/2" 10 C	bent
B	356600	2760	456	VOLVO	10	1	152							12,7	SAE 1 1/2" 10 C	double bent (long; R=100 mm)
C	356610	2761	456	VOLVO	10	1	152							12,7	SAE 1 1/2" 10 C	double bent (long; R=100 mm)
D	361760	4076	261	VOLVO	10	6	250	180	155	140	125	105		14	SAE 1 1/2" 10 C	bent
E	367260	3226	267	VOLVO	10	1	140							12,7	SAE 1 1/2" 10 C	double bent (long; R=100 mm)
F	384040	4104	284	VOLVO	10	1	133							12,7	SAE 1 1/2" 10 C	bent
G	414850	4085	414	VOLVO	10	1	152							16	SAE 1 1/2" 10 C	bent
H	507600	2760	907	VOLVO	10	3	205	165	140					12,7	SAE 1 1/2" 10 C	bent
I	507602	2760	907	VOLVO	10	1	140							12,7	SAE 1 1/2" 10 C	bent
J	507603	2760	907	VOLVO	10	1	165							12,7	SAE 1 1/2" 10 C	bent
K	507610	2761	907	VOLVO	10	3	205	165	140					12,7	SAE 1 1/2" 10 C	bent
L	507612	2761	907	VOLVO	10	1	165							12,7	SAE 1 1/2" 10 C	bent



VOLVO

VOLVO	3068	VOLVO	3069	VOLVO	4085
A		B		C	
	AYS CODE 507680 PART NUMBER 79698 AYS S-ABA CODE 801220 OEM NO 1581482		AYS CODE 507690 PART NUMBER 79697 AYS S-ABA CODE 801225 OEM NO 1581481		AYS CODE 507850 PART NUMBER 72903 AYS S-ABA CODE 803015 OEM NO 1581480
VOLVO	4085	VOLVO	2753	VOLVO	2754
D		E		F	
	AYS CODE 507851 PART NUMBER 72913 AYS S-ABA CODE 803080 OEM NO 1581487		AYS CODE 520530 PART NUMBER 72715 AYS S-ABA CODE OEM NO KB2565		AYS CODE 520540 PART NUMBER 72716 AYS S-ABA CODE OEM NO KB2570
VOLVO	2765	VOLVO	2766	VOLVO	2755
G		H		I	
	AYS CODE 521650 PART NUMBER 72722 AYS S-ABA CODE OEM NO 4W3810		AYS CODE 521660 PART NUMBER 72721 AYS S-ABA CODE OEM NO 4W3805		AYS CODE 553550 PART NUMBER 70572 AYS S-ABA CODE 800515 OEM NO 6970/F
VOLVO	2756	VOLVO	4085	VOLVO	4104
J		K		L	
	AYS CODE 553560 PART NUMBER 70571 AYS S-ABA CODE 800520 OEM NO 6969/F		AYS CODE 558850 PART NUMBER 72908 AYS S-ABA CODE 802990 OEM NO 1581800		AYS CODE 566040 PART NUMBER 72667 AYS S-ABA CODE 800275 OEM NO KB2255

	AYS CODE	CASTING	CONTROL UNIT	APPLICATION	SPLINE TEETH	NO of HOLE	H1	H2	H3	H4	H5	H6	H7	BUSHING (mm)	SPLINE TYPE	CONTROL ARM
A	507680	3068	907	VOLVO	10	1	152							16	SAE 1 1/2" 10 C	bent
B	507690	3069	907	VOLVO	10	1	152							16	SAE 1 1/2" 10 C	bent
C	507850	4085	907	VOLVO	10	1	152							16	SAE 1 1/2" 10 C	bent
D	507851	4085	907	VOLVO	10	1	165							16	SAE 1 1/2" 10 C	bent
E	520530	2753	920	VOLVO	10	1	133							12,7	SAE 1 1/2" 10 C	bent
F	520540	2754	920	VOLVO	10	1	133							12,7	SAE 1 1/2" 10 C	bent
G	521650	2765	921	VOLVO	10	1	159							12,7	SAE 1 1/2" 10 C	bent
H	521660	2766	921	VOLVO	10	1	159							12,7	SAE 1 1/2" 10 C	bent
I	553550	2755	953	VOLVO	10	1	140							12,7	SAE 1 1/2" 10 C	bent
J	553560	2756	953	VOLVO	10	1	140							12,7	SAE 1 1/2" 10 C	bent
K	558850	4085	958	VOLVO	10	1	152							12,7	SAE 1 1/2" 10 C	bent
L	566040	4104	966	VOLVO	10	1	140							12,7	SAE 1 1/2" 10 C	bent

VOLVO	4104	A		AYS CODE 566041 PART NUMBER 79271 AYS S-ABA CODE 802845 OEM NO 3013676
VOLVO	4085	B		AYS CODE 566850 PART NUMBER 72944 AYS S-ABA CODE 802995 OEM NO 1195316
VOLVO	4104	C		AYS CODE 583041 PART NUMBER 72677 AYS S-ABA CODE 802915 OEM NO KB2885
VOLVO	4085	D		AYS CODE 583850 PART NUMBER 72676 AYS S-ABA CODE 802990 OEM NO KB2705
VOLVO	4085	E		AYS CODE 593850 PART NUMBER 70932 AYS S-ABA CODE 803445 OEM NO 4737789
RENAULT	4008	F		AYS CODE 220100 PART NUMBER 79013 AYS S-ABA CODE 801520 OEM NO RVI44058
RENAULT	4008	G		AYS CODE 220105 PART NUMBER 79286 AYS S-ABA CODE 801490 OEM NO 4W3235
RENAULT	4009	H		AYS CODE 220200 PART NUMBER 79014 AYS S-ABA CODE 801525 OEM NO RVI44059
RENAULT	4009	I		AYS CODE 220203 PART NUMBER 79287 AYS S-ABA CODE 801495 OEM NO 4W3240
RENAULT	4008	J		AYS CODE 220301 PART NUMBER 79015 AYS S-ABA CODE 801510 OEM NO RVI44090
RENAULT	4008	K		AYS CODE 220304 PART NUMBER 79535 AYS S-ABA CODE 801500 OEM NO 5430053192
RENAULT	4009	L		AYS CODE 220400 PART NUMBER 79016 AYS S-ABA CODE 801515 OEM NO RVI44091

	AYS CODE	CASTING	CONTROL UNIT	APPLICATION	SPLINE TEETH	NO of HOLE	H1	H2	H3	H4	H5	H6	H7	BUSHING (mm)	SPLINE TYPE	CONTROL ARM
A	566041	4104	966	VOLVO	10	1	127							12,7	SAE 1 1/2" 10 C	bent
B	566850	4085	966	VOLVO	10	1	152							12,7	SAE 1 1/2" 10 C	bent
C	583041	4104	983	VOLVO	10	1	140							12,7	SAE 1 1/2" 10 C	bent
D	583850	4085	983	VOLVO	10	1	152							12,7	SAE 1 1/2" 10 C	bent
E	593850	4085	893	VOLVO	26	1	165							12,7	N42x1.5x9H DIN 5480	double bent (short; R=65 mm)
F	220100	4008	374	RENAULT	27	1	175							14	BNA 227 D3.5	double bent (short; R=65 mm)
G	220105	4008	374	RENAULT	27	1	160							14	BNA 227 D3.5	double bent (short; R=65 mm)
H	220200	4009	374	RENAULT	27	1	175							14	BNA 227 D3.5	double bent (short; R=65 mm)
I	220203	4009	374	RENAULT	27	1	160							14	BNA 227 D3.5	double bent (short; R=65 mm)
J	220301	4008	992	RENAULT	27	1	175							14	BNA 227 D3.5	double bent (short; R=65 mm)
K	220304	4008	992	RENAULT	27	1	160							14	BNA 227 D3.5	double bent (short; R=65 mm)
L	220400	4009	992	RENAULT	27	1	175							14	BNA 227 D3.5	double bent (short; R=65 mm)



RENAULT

RENAULT	4009	RENAULT	2752	RENAULT	4104
A		B		C	
	AYS CODE 220403 PART NUMBER 79536 AYS S-ABA CODE 801505 OEM NO 5430053193		AYS CODE 220500 PART NUMBER 79011 AYS S-ABA CODE 803460 OEM NO 4W3205		AYS CODE 220600 PART NUMBER 79012 AYS S-ABA CODE 803455 OEM NO 4W3835
RENAULT	4094	RENAULT	4095	RENAULT	2760
D		E		F	
	AYS CODE 220700 PART NUMBER 79289 AYS S-ABA CODE 802460 OEM NO KB2910		AYS CODE 220800 PART NUMBER 79288 AYS S-ABA CODE 802465 OEM NO KB2905		AYS CODE 220900 PART NUMBER 79018 AYS S-ABA CODE 802440 OEM NO RV144093
RENAULT	2760	RENAULT	2761	RENAULT	2761
G		H		I	
	AYS CODE 220902 PART NUMBER 79299 AYS S-ABA CODE 802430 OEM NO KB2640		AYS CODE 221000 PART NUMBER 79017 AYS S-ABA CODE 802445 OEM NO RV144092		AYS CODE 221002 PART NUMBER 79300 AYS S-ABA CODE 802435 OEM NO KB2645
RENAULT	4094	RENAULT	4095	RENAULT	4008
J		K		L	
	AYS CODE 221100 PART NUMBER 79304 AYS S-ABA CODE 802460 OEM NO 4W3485		AYS CODE 221200 PART NUMBER 79305 AYS S-ABA CODE 802465 OEM NO 4W3490		AYS CODE 221300 PART NUMBER 79009 AYS S-ABA CODE 801550 OEM NO 4W3825













	AYS CODE	CASTING	CONTROL UNIT	APPLICATION	SPLINE TEETH	NO of HOLE	H1	H2	H3	H4	H5	H6	H7	BUSHING (mm)	SPLINE TYPE	CONTROL ARM
A	220403	4009	992	RENAULT	27	1	160							14	BNA 227 D3.5	double bent (short; R=65 mm)
B	220500	2752	899	RENAULT	27	1	150							14	BNA 227 D3.5	double bent (short; R=65 mm)
C	220600	4104	900	RENAULT	27	1	140							14	BNA 227 D3.5	double bent (short; R=65 mm)
D	220700	4094	489	RENAULT	28	1	160							14	SAE 1 1/2" 28 C	double bent (short; R=65 mm)
E	220800	4095	489	RENAULT	28	1	160							14	SAE 1 1/2" 28 C	double bent (short; R=65 mm)
F	220900	2760	372	RENAULT	27	1	175							14	BNA 227 D3.5	double bent (short; R=65 mm)
G	220902	2760	372	RENAULT	27	1	160							14	BNA 227 D3.5	double bent (short; R=65 mm)
H	221000	2761	372	RENAULT	27	1	175							14	BNA 227 D3.5	double bent (short; R=65 mm)
I	221002	2761	372	RENAULT	27	1	160							14	BNA 227 D3.5	double bent (short; R=65 mm)
J	221100	4094	573	RENAULT	28	1	160							14	SAE 1 1/2" 28 C	double bent (short; R=65 mm)
K	221200	4095	573	RENAULT	28	1	160							14	SAE 1 1/2" 28 C	double bent (short; R=65 mm)
L	221300	4008	389	RENAULT	27	1	175							14	BNA 227 D3.5	bent

RENAULT	4009	RENAULT	4008	RENAULT	4009
A		B		C	
	AYS CODE 221400 PART NUMBER 79010 AYS S-ABA CODE 801555 OEM NO 4W3830		AYS CODE 221500 PART NUMBER 79020 AYS S-ABA CODE 801520 OEM NO 4W3085		AYS CODE 221600 PART NUMBER 79021 AYS S-ABA CODE 801525 OEM NO 4W3090
RENAULT	2752	RENAULT	2760	RENAULT	2761
D		E		F	
	AYS CODE 221700 PART NUMBER 79303 AYS S-ABA CODE 803470 OEM NO 5010152965		AYS CODE 236600 PART NUMBER 72634 AYS S-ABA CODE 802440 OEM NO 5810111405		AYS CODE 236610 PART NUMBER 72633 AYS S-ABA CODE 802445 OEM NO 5810111404
RENAULT	2894	RENAULT	2851	RENAULT	2852
G		H		I	
	AYS CODE 259940 PART NUMBER 72604 AYS S-ABA CODE OEM NO 4W3580		AYS CODE 302510 PART NUMBER 70544 AYS S-ABA CODE OEM NO 7701012135		AYS CODE 302520 PART NUMBER 70545 AYS S-ABA CODE OEM NO 7701012134
RENAULT	2853	RENAULT	2854	RENAULT	3156
J		K		L	
	AYS CODE 302531 PART NUMBER 70542 AYS S-ABA CODE OEM NO 5000928591		AYS CODE 302541 PART NUMBER 70543 AYS S-ABA CODE OEM NO 5000928592		AYS CODE 302560 PART NUMBER 79150 AYS S-ABA CODE OEM NO 4W3195

	AYS CODE	CASTING	CONTROL UNIT	APPLICATION	SPLINE TEETH	NO of HOLE	H1	H2	H3	H4	H5	H6	H7	BUSHING (mm)	SPLINE TYPE	CONTROL ARM
A	221400	4009	389	RENAULT	27	1	175							14	BNA 227 D3.5	bent
B	221500	4008	579	RENAULT	27	1	175							14	BNA 227 D3.5	double bent (short; R=65 mm)
C	221600	4009	579	RENAULT	27	1	175							14	BNA 227 D3.5	double bent (short; R=65 mm)
D	221700	2752	719	RENAULT	27	1	190							14	BNA 227 D3.5	double bent (short; R=65 mm)
E	236600	2760	236	RENAULT	27	1	175							14	BNA 227 D3.5	double bent (short; R=65 mm)
F	236610	2761	236	RENAULT	27	1	175							14	BNA 227 D3.5	double bent (short; R=65 mm)
G	259940	2894	359	RENAULT	33	1	140							14	PITCH 24/48	bent
H	302510	2851	402	RENAULT	27	1	238							14	BNA 227	bent
I	302520	2852	402	RENAULT	27	1	238							14	BNA 227	bent
J	302531	2853	402	RENAULT	27	1	258							14	BNA 227	bent
K	302541	2854	402	RENAULT	27	1	258							14	BNA 227	bent
L	302560	3156	402	RENAULT	27	1	190							14	BNA 227	bent



RENAULT

RENAULT	3157	RENAULT	2933	RENAULT	2934
A		B		C	
	AYS CODE 302570 PART NUMBER 79151 AYS S-ABA CODE OEM NO RV144077		AYS CODE 303330 PART NUMBER 70608 AYS S-ABA CODE OEM NO 08164958D		AYS CODE 303340 PART NUMBER 70609 AYS S-ABA CODE OEM NO 08164956B
RENAULT	2765	RENAULT	2766	RENAULT	4104
D		E		F	
	AYS CODE 306650 PART NUMBER 70620 AYS S-ABA CODE OEM NO 5000038238		AYS CODE 306660 PART NUMBER 70619 AYS S-ABA CODE OEM NO 5000038237		AYS CODE 312040 PART NUMBER 72599 AYS S-ABA CODE 803535 OEM NO 54300116310
RENAULT	4104	RENAULT	2931	RENAULT	2932
G		H		I	
	AYS CODE 312041 PART NUMBER 72601 AYS S-ABA CODE 803530 OEM NO 5430016393		AYS CODE 313310 PART NUMBER 70880 AYS S-ABA CODE OEM NO 08164954Z		AYS CODE 313320 PART NUMBER 70881 AYS S-ABA CODE OEM NO 5000568146
RENAULT	2851	RENAULT	2852	RENAULT	3068
J		K		L	
	AYS CODE 313510 PART NUMBER 70975 AYS S-ABA CODE OEM NO 5000882316		AYS CODE 313520 PART NUMBER 70976 AYS S-ABA CODE OEM NO 5000882317		AYS CODE 316680 PART NUMBER 70621 AYS S-ABA CODE 801470 OEM NO 5000037954

	AYS CODE	CASTING	CONTROL UNIT	APPLICATION	SPLINE TEETH	NO of HOLE	H1	H2	H3	H4	H5	H6	H7	BUSHING (mm)	SPLINE TYPE	CONTROL ARM
A	302570	3157	402	RENAULT	27	1	190							14	BNA 227	bent
B	303330	2933	403	RENAULT	27	1	238							14	BNA 227	bent
C	303340	2934	403	RENAULT	27	1	238							14	BNA 227	bent
D	306650	2765	406	RENAULT	27	1	190							14	BNA 227	bent
E	306660	2766	406	RENAULT	27	1	190							14	BNA 227	bent
F	312040	4104	412	RENAULT	33	1	140							14	PITCH 24/48	bent
G	312041	4104	412	RENAULT	33	1	127							14	PITCH 24/48	bent
H	313310	2931	413	RENAULT	27	1	258							14	BNA 227	bent
I	313320	2932	413	RENAULT	27	1	258							14	BNA 227	bent
J	313510	2851	413	RENAULT	27	1	238							14	BNA 227	bent
K	313520	2852	413	RENAULT	27	1	238							14	BNA 227	bent
L	316680	3068	416	RENAULT	27	1	190							14	BNA 227	bent

RENAULT	3069	RENAULT	2753	RENAULT	2754
A		B		C	
AYS CODE 316690	AYS CODE 318530	AYS CODE 318540	AYS CODE 318530	AYS CODE 318540	AYS CODE 318540
PART NUMBER 70622	PART NUMBER 79152	PART NUMBER 79152	PART NUMBER 79152	PART NUMBER 79153	PART NUMBER 79153
AYS S-ABA CODE 801475	AYS S-ABA CODE 801475	AYS S-ABA CODE 801475	AYS S-ABA CODE 801475	AYS S-ABA CODE 801475	AYS S-ABA CODE 801475
OEM NO 500037955	OEM NO RV144078	OEM NO RV144078	OEM NO RV144078	OEM NO 4W3215	OEM NO 4W3215
RENAULT	2901	RENAULT	2902	RENAULT	4085
D		E		F	
AYS CODE 357012	AYS CODE 357012	AYS CODE 357021	AYS CODE 357021	AYS CODE 359850	AYS CODE 359850
PART NUMBER 72137	PART NUMBER 72137	PART NUMBER 72138	PART NUMBER 72138	PART NUMBER 72600	PART NUMBER 72600
AYS S-ABA CODE 801035	AYS S-ABA CODE 801035	AYS S-ABA CODE 801040	AYS S-ABA CODE 801040	AYS S-ABA CODE 803540	AYS S-ABA CODE 803540
OEM NO 5000504467	OEM NO 5000504467	OEM NO 5000504468	OEM NO 5000504468	OEM NO 5000504468	OEM NO 5000504468
RENAULT	3717	RENAULT	3718	RENAULT	2760
G		H		I	
AYS CODE 388170	AYS CODE 388170	AYS CODE 388180	AYS CODE 388180	AYS CODE 389600	AYS CODE 389600
PART NUMBER 79290	PART NUMBER 79290	PART NUMBER 79291	PART NUMBER 79291	PART NUMBER cs	PART NUMBER cs
AYS S-ABA CODE 802005	AYS S-ABA CODE 802005	AYS S-ABA CODE 802010	AYS S-ABA CODE 802010	AYS S-ABA CODE 802460	AYS S-ABA CODE 802460
OEM NO 5010216246	OEM NO 5010216246	OEM NO 5010216247	OEM NO 5010216247	OEM NO 5010216246	OEM NO 5010216246
RENAULT	2761	RENAULT	3717	RENAULT	3718
J		K		L	
AYS CODE 389610	AYS CODE 389610	AYS CODE 407170	AYS CODE 407170	AYS CODE 407180	AYS CODE 407180
PART NUMBER cs	PART NUMBER cs	PART NUMBER 79292	PART NUMBER 79292	PART NUMBER 79293	PART NUMBER 79293
AYS S-ABA CODE 802465	AYS S-ABA CODE 802465	AYS S-ABA CODE 802005	AYS S-ABA CODE 802005	AYS S-ABA CODE 802010	AYS S-ABA CODE 802010
OEM NO 5010216246	OEM NO 5010216246	OEM NO 5010260344	OEM NO 5010260344	OEM NO 5010260345	OEM NO 5010260345

	AYS CODE	CASTING	CONTROL UNIT	APPLICATION	SPLINE TEETH	NO of HOLE	H1	H2	H3	H4	H5	H6	H7	BUSHING (mm)	SPLINE TYPE	CONTROL ARM
A	316690	3069	416	RENAULT	27	1	190							14	BNA 227	bent
B	318530	2753	418	RENAULT	27	1	183							14	BNA 227 D3.5	bent
C	318540	2754	418	RENAULT	27	1	183							14	BNA 227 D3.5	bent
D	357012	2901	257	RENAULT	19	1	170							14	A38x34 DIN 5482	double bent (medium; R=78 mm)
E	357021	2902	257	RENAULT	19	1	170							14	A38x34 DIN 5482	double bent (medium; R=78 mm)
F	359850	4085	359	RENAULT	33	1	150							14	PITCH 24/48	bent
G	388170	3717	488	RENAULT	27	1	175							14	BNA 227 D3.5	double bent (short; R=65 mm)
H	388180	3718	488	RENAULT	27	1	175							14	BNA 227 D3.5	double bent (short; R=65 mm)
I	389600	2760	489	RENAULT	28	1	160							14	SAE 1 1/2" 28 C	double bent (short; R=65 mm)
J	389610	2761	489	RENAULT	28	1	160							14	SAE 1 1/2" 28 C	double bent (short; R=65 mm)
K	407170	3717	707	RENAULT	27	1	175							14	BNA 227 D3.5	double bent (short; R=65 mm)
L	407180	3718	707	RENAULT	27	1	175							14	BNA 227 D3.5	double bent (short; R=65 mm)



RENAULT

RENAULT	4008	RENAULT	4009	RENAULT	3717
A		B		C	
	AYS CODE 416080 PART NUMBER 79301 AYS S-ABA CODE 801490 OEM NO KB2940		AYS CODE 416090 PART NUMBER 79302 AYS S-ABA CODE 801495 OEM NO KB2945		AYS CODE 423170 PART NUMBER 79474 AYS S-ABA CODE 801995 OEM NO 5010260085
RENAULT	3718	RENAULT	3717	RENAULT	3718
D		E		F	
	AYS CODE 423180 PART NUMBER 79475 AYS S-ABA CODE 802000 OEM NO 5010260086		AYS CODE 427170 PART NUMBER 79440 AYS S-ABA CODE 801985 OEM NO 5010197577		AYS CODE 427180 PART NUMBER 79441 AYS S-ABA CODE 801990 OEM NO 4W3755
RENAULT	4094	RENAULT	4095	RENAULT	3717
G		H		I	
	AYS CODE 427940 PART NUMBER 79306 AYS S-ABA CODE 802440 OEM NO 4W3840		AYS CODE 427950 PART NUMBER 79307 AYS S-ABA CODE 802445 OEM NO 5010260024		AYS CODE 433170 PART NUMBER 79296 AYS S-ABA CODE 801985 OEM NO KB2630
RENAULT	3717	RENAULT	3718	RENAULT	3718
J		K		L	
	AYS CODE 433171 PART NUMBER CS AYS S-ABA CODE OEM NO		AYS CODE 433180 PART NUMBER 79297 AYS S-ABA CODE 801990 OEM NO KB2635		AYS CODE 433181 PART NUMBER CS AYS S-ABA CODE OEM NO

	AYS CODE	CASTING	CONTROL UNIT	APPLICATION	SPLINE TEETH	NO of HOLE	H1	H2	H3	H4	H5	H6	H7	BUSHING (mm)	SPLINE TYPE	CONTROL ARM
A	416080	4008	716	RENAULT	27	1	160							14	BNA 227 D3.5	double bent (short; R=65 mm)
B	416090	4009	716	RENAULT	27	1	160							14	BNA 227 D3.5	double bent (short; R=65 mm)
C	423170	3717	723	RENAULT	27	1	175							14	BNA 227 D3.5	double bent (short; R=65 mm)
D	423180	3718	723	RENAULT	27	1	175							14	BNA 227 D3.5	double bent (short; R=65 mm)
E	427170	3717	627	RENAULT	27	1	160							14	BNA 227 D3.5	double bent (short; R=65 mm)
F	427180	3718	627	RENAULT	27	1	160							14	BNA 227 D3.5	double bent (short; R=65 mm)
G	427940	4094	627	RENAULT	27	1	175							14	BNA 227 D3.5	double bent (short; R=65 mm)
H	427950	4095	627	RENAULT	27	1	175							14	BNA 227 D3.5	double bent (short; R=65 mm)
I	433170	3717	733	RENAULT	27	1	160							14	BNA 227 D3.5	double bent (short; R=65 mm)
J	433171	3717	733	RENAULT	26	1	160							14	N42x1.5x9H DIN 5480	double bent (short; R=65 mm)
K	433180	3718	733	RENAULT	27	1	160							14	BNA 227 D3.5	double bent (short; R=65 mm)
L	433181	3718	733	RENAULT	26	1	160							14	N42x1.5x9H DIN 5480	double bent (short; R=65 mm)

RENAULT	3717	RENAULT	3718	RENAULT	4004
A		B		C	
	AYS CODE 447170 PART NUMBER 79476 AYS S-ABA CODE 801975 OEM NO 5010260089		AYS CODE 447180 PART NUMBER 79477 AYS S-ABA CODE 801980 OEM NO 5010260090		AYS CODE 459040 PART NUMBER 72602 AYS S-ABA CODE OEM NO 5430016305
RENAULT	4005	RENAULT	4104	RENAULT	3717
D		E		F	
	AYS CODE 459050 PART NUMBER 72603 AYS S-ABA CODE OEM NO 4W3515		AYS CODE 473040 PART NUMBER 79019 AYS S-ABA CODE 803455 OEM NO 4W2980		AYS CODE 479170 PART NUMBER 79628 AYS S-ABA CODE 802005 OEM NO KB2870
RENAULT	3718	RENAULT	3717	RENAULT	3717
G		H		I	
	AYS CODE 479180 PART NUMBER 79629 AYS S-ABA CODE 802010 OEM NO KB2875		AYS CODE 496170 PART NUMBER 79294 AYS S-ABA CODE 801985 OEM NO KB2920		AYS CODE 496171 PART NUMBER 79581 AYS S-ABA CODE 802005 OEM NO 1944551
RENAULT	3717	RENAULT	3718	RENAULT	3718
J		K		L	
	AYS CODE 496172 PART NUMBER CS AYS S-ABA CODE OEM NO		AYS CODE 496180 PART NUMBER 79295 AYS S-ABA CODE 801990 OEM NO KB2925		AYS CODE 496181 PART NUMBER 79582 AYS S-ABA CODE 802010 OEM NO 1944552













	AYS CODE	CASTING	CONTROL UNIT	APPLICATION	SPLINE TEETH	NO of HOLE	H1	H2	H3	H4	H5	H6	H7	BUSHING (mm)	SPLINE TYPE	CONTROL ARM
A	447170	3717	747	RENAULT	27	1	160							14	BNA 227 D3.5	double bent (short; R=65 mm)
B	447180	3718	747	RENAULT	27	1	160							14	BNA 227 D3.5	double bent (short; R=65 mm)
C	459040	4004	359	RENAULT	33	1	140							14	PITCH 24/48	bent
D	459050	4005	359	RENAULT	33	1	140							14	PITCH 24/48	bent
E	473040	4104	573	RENAULT	27	1	140							14	BNA 227 D3.5	double bent (short; R=65 mm)
F	479170	3717	579	RENAULT	27	1	175							14	BNA 227 D3.5	double bent (short; R=65 mm)
G	479180	3718	579	RENAULT	27	1	175							14	BNA 227 D3.5	double bent (short; R=65 mm)
H	496170	3717	696	RENAULT	27	1	160							14	BNA 227 D3.5	double bent (short; R=65 mm)
I	496171	3717	696	RENAULT	27	1	175							14	BNA 227 D3.5	double bent (short; R=65 mm)
J	496172	3717	696	RENAULT	26	1	160							14	N42x1.5x9H DIN 5480	double bent (short; R=65 mm)
K	496180	3718	696	RENAULT	27	1	160							14	BNA 227 D3.5	double bent (short; R=65 mm)
L	496181	3718	696	RENAULT	27	1	175							14	BNA 227 D3.5	double bent (short; R=65 mm)



RENAULT

RENAULT	3718	RENAULT	3717	RENAULT	3718
A		B		C	
	AYS CODE 496182		AYS CODE 500170		AYS CODE 500180
	PART NUMBER CS		PART NUMBER 70897		PART NUMBER 70896
	AYS S-ABA CODE		AYS S-ABA CODE 801995		AYS S-ABA CODE 802000
	OEM NO		OEM NO 5000470831		OEM NO 5000470830
RENAULT	3717	RENAULT	3717	RENAULT	3718
D		E		F	
	AYS CODE 512170		AYS CODE 512171		AYS CODE 512180
	PART NUMBER 79308		PART NUMBER 79310		PART NUMBER 79309
	AYS S-ABA CODE 801965		AYS S-ABA CODE 801955		AYS S-ABA CODE 801970
	OEM NO 4W3055		OEM NO SPK/1262B		OEM NO 4W3050
RENAULT	3718	RENAULT	4085	RENAULT	3718
G		H		I	
	AYS CODE 512181		AYS CODE 560851		AYS CODE 569180
	PART NUMBER 79311		PART NUMBER 79298		PART NUMBER 70899
	AYS S-ABA CODE 801960		AYS S-ABA CODE 803515		AYS S-ABA CODE 802015
	OEM NO HB100394		OEM NO 5010201995		OEM NO 5000470912
RENAULT	3720	RENAULT	2853	RENAULT	2854
J		K		L	
	AYS CODE 569200		AYS CODE 569530		AYS CODE 569540
	PART NUMBER 70898		PART NUMBER 70855		PART NUMBER 70856
	AYS S-ABA CODE		AYS S-ABA CODE		AYS S-ABA CODE
	OEM NO 5000470911		OEM NO 5000467831		OEM NO 5000467832











	AYS CODE	CASTING	CONTROL UNIT	APPLICATION	SPLINE TEETH	NO of HOLE	H1	H2	H3	H4	H5	H6	H7	BUSHING (mm)	SPLINE TYPE	CONTROL ARM
A	496182	3718	696	RENAULT	26	1	160							14	N42x1.5x9H DIN 5480	double bent (short; R=65 mm)
B	500170	3717	900	RENAULT	27	1	175							14	BNA 227	double bent (short; R=65 mm)
C	500180	3718	900	RENAULT	27	1	175							14	BNA 227	double bent (short; R=65 mm)
D	512170	3717	812	RENAULT	27	1	175							14	BNA 227 D3.5	double bent (short; R=65 mm)
E	512171	3717	812	RENAULT	27	1	160							14	BNA 227 D3.5	double bent (short; R=65 mm)
F	512180	3718	812	RENAULT	27	1	175							14	BNA 227 D3.5	double bent (short; R=65 mm)
G	512181	3718	812	RENAULT	27	1	160							14	BNA 227 D3.5	double bent (short; R=65 mm)
H	560851	4085	860	RENAULT	28	1	160							14	SAE 1 1/2" 28 C	double bent (short; R=65 mm)
I	569180	3718	869	RENAULT	27	1	246							16	BNA 227 D3.5	double bent (short; R=65 mm)
J	569200	3720	869	RENAULT	27	1	246							16	BNA 227 D3.5	double bent (short; R=65 mm)
K	569530	2853	869	RENAULT	19	1	240							16	A38x34 DIN 5482	double bent (short; R=65 mm)
L	569540	2854	869	RENAULT	19	1	240							16	A38x34 DIN 5482	double bent (short; R=65 mm)

RENAULT	3214	RENAULT	3215	RENAULT	4008
A		B		C	
	AYS CODE 578140 PART NUMBER 79431 AYS S-ABA CODE OEM NO 4W3275		AYS CODE 578150 PART NUMBER 79432 AYS S-ABA CODE OEM NO 4W3280		AYS CODE 581080 PART NUMBER 79007 AYS S-ABA CODE 801540 OEM NO RVI44035
RENAULT	4009	RENAULT	3717	RENAULT	3718
D		E		F	
	AYS CODE 581090 PART NUMBER 79008 AYS S-ABA CODE 801545 OEM NO RVI44036		AYS CODE 590170 PART NUMBER 79478 AYS S-ABA CODE 801975 OEM NO 5010260087		AYS CODE 590180 PART NUMBER 79479 AYS S-ABA CODE 801980 OEM NO 5010260088
RENAULT	4008	RENAULT	4009	SAF	4076
G		H		I	
	AYS CODE 591080 PART NUMBER 79312 AYS S-ABA CODE 801530 OEM NO 4W3850		AYS CODE 591090 PART NUMBER 79313 AYS S-ABA CODE 801535 OEM NO 4W3855		AYS CODE 210000 PART NUMBER 79005 AYS S-ABA CODE 800070 OEM NO TP02003009X
SAF	4086	SAF	4076	SAF	4097
J		K		L	
	AYS CODE 210030 PART NUMBER 79006 AYS S-ABA CODE 800070 OEM NO M046514		AYS CODE 210700 PART NUMBER cs AYS S-ABA CODE 800410 OEM NO		AYS CODE 267900 PART NUMBER 79240 AYS S-ABA CODE 800070 OEM NO 4175026100











	AYS CODE	CASTING	CONTROL UNIT	APPLICATION	SPLINE TEETH	NO of HOLE	H1	H2	H3	H4	H5	H6	H7	BUSHING (mm)	SPLINE TYPE	CONTROL ARM
A	578140	3214	978	RENAULT	27	1	270							14	BNA 227 D3.5	bent
B	578150	3215	978	RENAULT	27	1	270							14	BNA 227 D3.5	bent
C	581080	4008	981	RENAULT	27	1	175							14	BNA 227 D3.5	bent
D	581090	4009	981	RENAULT	27	1	175							14	BNA 227 D3.5	bent
E	590170	3717	890	RENAULT	27	1	160							14	BNA 227 D3.5	double bent (short; R=65 mm)
F	590180	3718	890	RENAULT	27	1	160							14	BNA 227 D3.5	double bent (short; R=65 mm)
G	591080	4008	991	RENAULT	27	1	175							14	BNA 227 D3.5	double bent (short; R=65 mm)
H	591090	4009	991	RENAULT	27	1	175							14	BNA 227 D3.5	double bent (short; R=65 mm)
I	210000	4076	635	SAF	10	6	250	180	155	140	125	105		14	SAE 1 1/2" 10 C	ays-saddle type
J	210030	4086	635	SAF	10	3	153	129	105					14	SAE 1 1/2" 10 C	ays-saddle type
K	210700	4076	635	SAF	37	6	250	180	155	140	125	105		14	A36x40 DIN 5481	ays-saddle type
L	267900	4097	167	SAF	10	4	180	155	140	125				14	SAE 1 1/2" 10 C	ays-saddle type



SAF

A	SAF	2752		SAF	4076		SAF	2752	
			AYS CODE 311500 PART NUMBER 72554 AYS S-ABA CODE 803190 OEM NO 4175018100			AYS CODE 320900 PART NUMBER 72702 AYS S-ABA CODE 800070 OEM NO			AYS CODE 321100 PART NUMBER 79090 AYS S-ABA CODE 803185 OEM NO 4175025700
D	SAF	4076		SAF	2752		SAF	3068	
			AYS CODE 321200 PART NUMBER 72645 AYS S-ABA CODE 803675 OEM NO 0517482112			AYS CODE 321300 PART NUMBER 72053 AYS S-ABA CODE 803210 OEM NO 4W1125			AYS CODE 321400 PART NUMBER 70969 AYS S-ABA CODE 801340 OEM NO 4W1215
G	SAF	3069		SAF	2752		SAF	2760	
			AYS CODE 321500 PART NUMBER 70970 AYS S-ABA CODE 801345 OEM NO 4W1220			AYS CODE 322521 PART NUMBER 72334 AYS S-ABA CODE 803155 OEM NO			AYS CODE 322601 PART NUMBER 70802 AYS S-ABA CODE 802300 OEM NO MAS9250
J	SAF	2761		SAF	4076		SAF	4032	
			AYS CODE 322611 PART NUMBER 70803 AYS S-ABA CODE 802305 OEM NO MAS9251			AYS CODE 322760 PART NUMBER 72763 AYS S-ABA CODE 800055 OEM NO			AYS CODE 326321 PART NUMBER 72271 AYS S-ABA CODE 800055 OEM NO













	AYS CODE	CASTING	CONTROL UNIT	APPLICATION	SPLINE TEETH	NO of HOLE	H1	H2	H3	H4	H5	H6	H7	BUSHING (mm)	SPLINE TYPE	CONTROL ARM
A	311500	2752	401	SAF	10	1	203							14	SAE 1 1/2" 10 C	bent
B	320900	4076	632	SAF	10	6	250	180	155	140	125	105		14	SAE 1 1/2" 10 C	bent
C	321100	2752	816	SAF	10	4	203	178	152	127				14	SAE 1 1/2" 10 C	bent
D	321200	4076	511	SAF	10	5	250	180	150	130	110			14 (L1: x)	SAE 1 1/2" 10 C	bent
E	321300	2752	270	SAF	10	4	210	180	150	125				14	SAE 1 1/2" 10 C	double bent (short; R=65 mm)
F	321400	3068	422	SAF	10	3	198	173	148					14	SAE 1 1/2" 10 C	bent
G	321500	3069	422	SAF	10	3	198	173	148					14	SAE 1 1/2" 10 C	bent
H	322521	2752	422	SAF	10	3	200	155	130					14	SAE 1 1/2" 10 C	bent
I	322601	2760	422	SAF	10	3	203	179	151					14	SAE 1 1/2" 10 C	bent
J	322611	2761	422	SAF	10	3	203	179	151					14	SAE 1 1/2" 10 C	bent
K	322760	4076	422	SAF	10	6	250	180	165	150	135	120		14	SAE 1 1/2" 10 C	bent
L	326321	4032	426	SAF	10	4	250	195	165	135				14	SAE 1 1/2" 10 C	bent

SAF	3865	SAF	3863	SAF	3864
A		B		C	
	AYS CODE 359650 PART NUMBER 70949 AYS S-ABA CODE OEM NO KB1080		AYS CODE 366630 PART NUMBER 72238 AYS S-ABA CODE OEM NO 4W1160		AYS CODE 366640 PART NUMBER 72239 AYS S-ABA CODE OEM NO KB1110
SAF	3863	SAF	3864	SAF	4032
D		E		F	
	AYS CODE 371630 PART NUMBER 72007 AYS S-ABA CODE OEM NO 4W1135		AYS CODE 371640 PART NUMBER 72008 AYS S-ABA CODE OEM NO 4W1130		AYS CODE 432320 PART NUMBER 72250 AYS S-ABA CODE 800070 OEM NO
SAF	4086	SAF	4032	SAF	4076
G		H		I	
	AYS CODE 432861 PART NUMBER 72270 AYS S-ABA CODE 800070 OEM NO		AYS CODE 435300 PART NUMBER 72948 AYS S-ABA CODE 800070 OEM NO KB1075		AYS CODE 435760 PART NUMBER cs AYS S-ABA CODE 803685 OEM NO
SAF	4086	SAF	4097	SAF	4032
J		K		L	
	AYS CODE 435804 PART NUMBER 79035 AYS S-ABA CODE 800070 OEM NO 4175024800		AYS CODE 435971 PART NUMBER cs AYS S-ABA CODE 800050 OEM NO		AYS CODE 470320 PART NUMBER 72863 AYS S-ABA CODE 800070 OEM NO

	AYS CODE	CASTING	CONTROL UNIT	APPLICATION	SPLINE TEETH	NO of HOLE	H1	H2	H3	H4	H5	H6	H7	BUSHING (mm)	SPLINE TYPE	CONTROL ARM
A	359650	3865	459	SAF	10	4	200	176	152	127				14 (L1: x)	SAE 1 1/2" 10 C	double bent (long; R=100 mm)
B	366630	3863	266	SAF	10	3	178	152	127					14	SAE 1 1/2" 10 C	double bent (medium; R=78 mm)
C	366640	3864	266	SAF	10	3	178	152	127					14	SAE 1 1/2" 10 C	double bent (medium; R=78 mm)
D	371630	3863	471	SAF	10	3	178	152	127					14	SAE 1 1/2" 10 C	double bent (medium; R=78 mm)
E	371640	3864	471	SAF	10	3	178	152	127					14	SAE 1 1/2" 10 C	double bent (medium; R=78 mm)
F	432320	4032	632	SAF	10	5	250	210	180	150	125			14	SAE 1 1/2" 10 C	bent
G	432861	4086	632	SAF	10	3	153	129	105					14	SAE 1 1/2" 10 C	bent
H	435300	4032	635	SAF	10	5	250	210	180	150	125			14	SAE 1 1/2" 10 C	ays-saddle type
I	435760	4076	635	SAF	10	6	250	180	155	140	125	105		14	SAE 1 1/2" 10 C	ays-saddle type
J	435804	4086	635	SAF	10	5	215	181	153	129	105			14	SAE 1 1/2" 10 C	ays-saddle type
K	435971	4097	635	SAF	10	4	180	155	140	125				14	SAE 1 1/2" 10 C	ays-saddle type
L	470320	4032	570	SAF	10	5	215	181	153	129	105			14	SAE 1 1/2" 10 C	bent



SAF

SAF	4086	SAF	4086	SAF	4086
A		B		C	
	AYS CODE 470860 PART NUMBER 72269 AYS S-ABA CODE 800080 OEM NO		AYS CODE 470862 PART NUMBER 72576 AYS S-ABA CODE 803620 OEM NO KB1030		AYS CODE 470863 PART NUMBER 72581 AYS S-ABA CODE 800060 OEM NO KB1040
SAF	4087	SAF	4088	SAF	2752
D		E		F	
	AYS CODE 470870 PART NUMBER 79052 AYS S-ABA CODE 800435 OEM NO 4175025000		AYS CODE 470880 PART NUMBER 79053 AYS S-ABA CODE 800440 OEM NO 4175025100		AYS CODE 492520 PART NUMBER 72710 AYS S-ABA CODE 803210 OEM NO KB1035
SAF	2760	SAF	2761	SAF	2765
G		H		I	
	AYS CODE 503600 PART NUMBER 79043 AYS S-ABA CODE 802275 OEM NO 4175023500		AYS CODE 503610 PART NUMBER 79044 AYS S-ABA CODE 802285 OEM NO 4175023600		AYS CODE 503650 PART NUMBER 79038 AYS S-ABA CODE OEM NO 4175024100
SAF	2766	SAF	3883	SAF	3884
J		K		L	
	AYS CODE 503660 PART NUMBER 79039 AYS S-ABA CODE OEM NO 4175024200		AYS CODE 503830 PART NUMBER 79087 AYS S-ABA CODE OEM NO 4175023800		AYS CODE 503840 PART NUMBER 79086 AYS S-ABA CODE OEM NO 4175023700

	AYS CODE	CASTING	CONTROL UNIT	APPLICATION	SPLINE TEETH	NO of HOLE	H1	H2	H3	H4	H5	H6	H7	BUSHING (mm)	SPLINE TYPE	CONTROL ARM
A	470860	4086	570	SAF	10	4	210	180	150	125				14	SAE 1 1/2" 10 C	bent
B	470862	4086	570	SAF	10	4	203	165	140	115				14	SAE 1 1/2" 10 C	bent
C	470863	4086	570	SAF	10	5	215	181	153	129	105			14	SAE 1 1/2" 10 C	bent
D	470870	4087	570	SAF	10	2	152	127						14	SAE 1 1/2" 10 C	bent
E	470880	4088	570	SAF	10	2	152	127						14	SAE 1 1/2" 10 C	bent
F	492520	2752	692	SAF	10	4	210	180	150	125				14	SAE 1 1/2" 10 C	double bent (short; R=65 mm)
G	503600	2760	803	SAF	10	2	179	152						14	SAE 1 1/2" 10 C	double bent (short; R=65 mm)
H	503610	2761	803	SAF	10	2	179	152						14	SAE 1 1/2" 10 C	double bent (short; R=65 mm)
I	503650	2765	803	SAF	10	3	178	152	127					14	SAE 1 1/2" 10 C	double bent (short; R=65 mm)
J	503660	2766	803	SAF	10	3	178	152	127					14	SAE 1 1/2" 10 C	double bent (short; R=65 mm)
K	503830	3883	803	SAF	10	1	130							14	SAE 1 1/2" 10 C	double bent (short; R=65 mm)
L	503840	3884	803	SAF	10	1	130							14	SAE 1 1/2" 10 C	double bent (short; R=65 mm)

A	KÄSSBOHRER	4076	AYS CODE 210200	PART NUMBER 72758	AYS S-ABA CODE 803775	OEM NO KB2085	B	KÄSSBOHRER	2752	AYS CODE 304520	PART NUMBER 70687	AYS S-ABA CODE 803545	OEM NO	C	KÄSSBOHRER	2771	AYS CODE 304710	PART NUMBER 72426	AYS S-ABA CODE	OEM NO 82852450000
D	KÄSSBOHRER	2772	AYS CODE 304720	PART NUMBER 72427	AYS S-ABA CODE	OEM NO 82852460000	E	KÄSSBOHRER	2760	AYS CODE 312600	PART NUMBER 70718	AYS S-ABA CODE 802380	OEM NO	F	KÄSSBOHRER	2760	AYS CODE 312601	PART NUMBER 72014	AYS S-ABA CODE 802370	OEM NO 4W3255
G	KÄSSBOHRER	2761	AYS CODE 312610	PART NUMBER 70719	AYS S-ABA CODE 802385	OEM NO	H	KÄSSBOHRER	2761	AYS CODE 312611	PART NUMBER 72015	AYS S-ABA CODE 802375	OEM NO 4W3260	I	KÄSSBOHRER	2752	AYS CODE 339520	PART NUMBER 72376	AYS S-ABA CODE 803500	OEM NO
J	KÄSSBOHRER	3226	AYS CODE 348260	PART NUMBER 72016	AYS S-ABA CODE 800830	OEM NO 82830003360	K	KÄSSBOHRER	2752	AYS CODE 350100	PART NUMBER 70989	AYS S-ABA CODE 803545	OEM NO 82830007570	L	KÄSSBOHRER	2985	AYS CODE 350300	PART NUMBER 72017	AYS S-ABA CODE 802670	OEM NO 82830005890

	AYS CODE	CASTING	CONTROL UNIT	APPLICATION	SPLINE TEETH	NO of HOLE	H1	H2	H3	H4	H5	H6	H7	BUSHING (mm)	SPLINE TYPE	CONTROL ARM
A	210200	4076	807	KÄSSBOHRER	37	6	250	180	165	150	135	120		14 (L1: x)	A36x40 DIN 5481	bent
B	304520	2752	404	KÄSSBOHRER	37	2	180	150						14	A36x40 DIN 5481	bent
C	304710	2771	404	KÄSSBOHRER	28	1	140							12,7	SAE 1 1/2" 28 C	bent
D	304720	2772	404	KÄSSBOHRER	28	1	140							12,7	SAE 1 1/2" 28 C	bent
E	312600	2760	412	KÄSSBOHRER	19	1	170							14	A38x34 DIN 5482	bent
F	312601	2760	412	KÄSSBOHRER	19	1	160							14	A38x34 DIN 5482	bent
G	312610	2761	412	KÄSSBOHRER	19	1	170							14	A38x34 DIN 5482	bent
H	312611	2761	412	KÄSSBOHRER	19	1	160							14	A38x34 DIN 5482	bent
I	339520	2752	439	KÄSSBOHRER	28	1	145							12,7	SAE 1 7/16" 28 C	bent
J	348260	3226	448	KÄSSBOHRER	19	1	145							14	A38x34 DIN 5482	bent
K	350100	2752	972	KÄSSBOHRER	37	2	180	150						14	A36x40 DIN 5481	bent
L	350300	2985	765	KÄSSBOHRER	19	1	160							14	A38x34 DIN 5482	bent



ABA
Automatic Brake Adjuster / Otomatik Fren Ayar Kolu.
S-ABA
(Self Setting) Automatic Brake Adjuster / Tam Otomatik Fren Ayar Kolu.

* CS > Customer Specific / Özel İmalat

PRODUCT PICTURES ARE TAKEN OF REFERENCE FOR CASTING BODIES. ALSO PLEASE IGNORE CONTROL UNIT & ITS POSITION. ÜRÜN FOTOĞRAFLARI GÖVDELER REFERANS ALINARAK YERLEŞTİRİLMİŞTİR. KİLİT VE KİLİT AÇILARINI DİKKATE ALMAYINIZ.

ALL ORIGINAL NUMBERS, MARKS AND MODELS FROM VEHICLE MANUFACTURERS LISTED IN THIS CATALOGUE ARE FOR COMPARISON PURPOSES ONLY AND MAY NOT BE USED IN INVOICES TO VEHICLE OWNERS OR RESELLERS. / ORJİNAL ÜRÜN NUMARALARI MÜŞTERİYİ BİLGİLENDİRME VE ÜRÜNE REFERANS AMAÇLI KULLANILMIŞTIR.

KÄSSBOHRER

A	KÄSSBOHRER	2987	AYS CODE 350400	PART NUMBER 72018	AYS S-ABA CODE 802675	OEM NO 82830005900	B	KÄSSBOHRER	2760	AYS CODE 364600	PART NUMBER 72370	AYS S-ABA CODE 802390	OEM NO 82850000920	C	KÄSSBOHRER	2761	AYS CODE 364610	PART NUMBER 72371	AYS S-ABA CODE 802395	OEM NO 82850000910
D	KÄSSBOHRER	2760	AYS CODE 385600	PART NUMBER 72591	AYS S-ABA CODE 802350	OEM NO 4W3575	E	KÄSSBOHRER	2761	AYS CODE 385610	PART NUMBER 72592	AYS S-ABA CODE 802355	OEM NO 4W2975	F	KÄSSBOHRER	4032	AYS CODE 490320	PART NUMBER 72416	AYS S-ABA CODE 803775	OEM NO 4W3015
G	KÄSSBOHRER	4085	AYS CODE 515850	PART NUMBER 70720	AYS S-ABA CODE 801775	OEM NO 4W2965	H	KÄSSBOHRER	2894	AYS CODE 520940	PART NUMBER 70716	AYS S-ABA CODE	OEM NO 82830003080	I	KÄSSBOHRER	2895	AYS CODE 520950	PART NUMBER 70717	AYS S-ABA CODE	OEM NO 82830003090
J	KÄSSBOHRER	2760	AYS CODE 553600	PART NUMBER 79040	AYS S-ABA CODE 802400	OEM NO 4W3680	K	KÄSSBOHRER	2761	AYS CODE 553610	PART NUMBER 79041	AYS S-ABA CODE 802405	OEM NO 4W3685	L	KÄSSBOHRER	2753	AYS CODE 557530	PART NUMBER 72374	AYS S-ABA CODE	OEM NO 82850000810

	AYS CODE	CASTING	CONTROL UNIT	APPLICATION	SPLINE TEETH	NO of HOLE	H1	H2	H3	H4	H5	H6	H7	BUSHING (mm)	SPLINE TYPE	CONTROL ARM
A	350400	2987	765	KÄSSBOHRER	19	1	160							14	A38x34 DIN 5482	bent
B	364600	2760	364	KÄSSBOHRER	19	1	175							14	A38x34 DIN 5482	double bent (long; R=100 mm)
C	364610	2761	364	KÄSSBOHRER	19	1	175							14	A38x34 DIN 5482	double bent (long; R=100 mm)
D	385600	2760	485	KÄSSBOHRER	19	1	150							14	A38x34 DIN 5482	bent
E	385610	2761	485	KÄSSBOHRER	19	1	150							14	A38x34 DIN 5482	bent
F	490320	4032	590	KÄSSBOHRER	37	4	250	180	150	120				14	A36x40 DIN 5481	bent
G	515850	4085	915	KÄSSBOHRER	19	1	145							14	A38x34 DIN 5482	bent
H	520940	2894	920	KÄSSBOHRER	19	1	170							14	A38x34 DIN 5482	bent
I	520950	2895	920	KÄSSBOHRER	19	1	170							14	A38x34 DIN 5482	bent
J	553600	2760	953	KÄSSBOHRER	19	1	175							14	A38x34 DIN 5482	bent
K	553610	2761	953	KÄSSBOHRER	19	1	175							14	A38x34 DIN 5482	bent
L	557530	2753	957	KÄSSBOHRER	10	1	175							16	SAE 1 1/2" 10 C	bent

A	KÄSSBOHRER	2754		AYS CODE 557540 PART NUMBER 72375 AYS S-ABA CODE OEM NO 82850000820
B	KÄSSBOHRER	2760		AYS CODE 557600 PART NUMBER 72372 AYS S-ABA CODE 802470 OEM NO 82850000790
C	KÄSSBOHRER	2761		AYS CODE 557610 PART NUMBER 72373 AYS S-ABA CODE 802475 OEM NO 82850000800
D	VAN HOOL	2753		AYS CODE 373530 PART NUMBER 72461 AYS S-ABA CODE OEM NO 4W3035
E	VAN HOOL	2754		AYS CODE 373540 PART NUMBER 72462 AYS S-ABA CODE OEM NO 4W3030
F	VAN HOOL	3068		AYS CODE 373680 PART NUMBER 72646 AYS S-ABA CODE 801360 OEM NO 4W3225
G	VAN HOOL	3069		AYS CODE 380501 PART NUMBER 72647 AYS S-ABA CODE 801365 OEM NO 4W3230
H	VAN HOOL	2752(4085)		AYS CODE 500520 PART NUMBER 70905 AYS S-ABA CODE 803000 OEM NO 4W2460
I	VAN HOOL	2753		AYS CODE 500530 PART NUMBER 72459 AYS S-ABA CODE OEM NO 4W2775
J	VAN HOOL	2754		AYS CODE 500540 PART NUMBER 72460 AYS S-ABA CODE OEM NO 4W2780
K	VAN HOOL	4085		AYS CODE 500851 PART NUMBER 72330 AYS S-ABA CODE 803290 OEM NO 4W2960
L	VAN HOOL	4087		AYS CODE 500870 PART NUMBER 79163 AYS S-ABA CODE 800685 OEM NO 4W3410

	AYS CODE	CASTING	CONTROL UNIT	APPLICATION	SPLINE TEETH	NO of HOLE	H1	H2	H3	H4	H5	H6	H7	BUSHING (mm)	SPLINE TYPE	CONTROL ARM
A	557540	2754	957	KÄSSBOHRER	10	1	175							16	SAE 1 1/2" 10 C	bent
B	557600	2760	957	KÄSSBOHRER	28	1	175							12,7	SAE 1 1/2" 28 C	bent
C	557610	2761	957	KÄSSBOHRER	28	1	175							12,7	SAE 1 1/2" 28 C	bent
D	373530	2753	373	VAN HOOL	19	1	150							14	A38x34 DIN 5482	double bent (short; R=65 mm)
E	373540	2754	373	VAN HOOL	19	1	150							14	A38x34 DIN 5482	double bent (short; R=65 mm)
F	373680	3068	373	VAN HOOL	19	1	150							14	A38x34 DIN 5482	double bent (short; R=65 mm)
G	380501	3069	373	VAN HOOL	19	1	150							14	A38x34 DIN 5482	double bent (short; R=65 mm)
H	500520	2752(4085)	900	VAN HOOL	10	1	152							14	SAE 1 1/2" 10 C	double bent (short; R=65 mm)
I	500530	2753	900	VAN HOOL	19	1	160							14	A38x34 DIN 5482	double bent (short; R=65 mm)
J	500540	2754	900	VAN HOOL	19	1	160							14	A38x34 DIN 5482	double bent (short; R=65 mm)
K	500851	4085	900	VAN HOOL	19	1	152							14	A38x34 DIN 5482	double bent (short; R=65 mm)
L	500870	4087	900	VAN HOOL	10	1	152							14	SAE 1 1/2" 10 C	double bent (short; R=65 mm)



VAN HOOL / BABELSBERGER / BARTOLETTI

VAN HOOL	4087	VAN HOOL	4088	VAN HOOL	4088
A		B		C	
	AYS CODE 500871 PART NUMBER 79166 AYS S-ABA CODE 800705 OEM NO		AYS CODE 500880 PART NUMBER 79162 AYS S-ABA CODE 800690 OEM NO 4W3415		AYS CODE 500881 PART NUMBER 79165 AYS S-ABA CODE 800710 OEM NO
VAN HOOL	4085	VAN HOOL	2755	VAN HOOL	2756
D		E		F	
	AYS CODE 509850 PART NUMBER 10519 AYS S-ABA CODE 803465 OEM NO		AYS CODE 578550 PART NUMBER 79094 AYS S-ABA CODE 800615 OEM NO E75701134		AYS CODE 578560 PART NUMBER 79095 AYS S-ABA CODE 800620 OEM NO E75701137
VAN HOOL	4077	VAN HOOL	4078	VAN HOOL	2894
G		H		I	
	AYS CODE 578770 PART NUMBER 72921 AYS S-ABA CODE OEM NO 4W3955		AYS CODE 578780 PART NUMBER 72922 AYS S-ABA CODE OEM NO 4W3960		AYS CODE 581940 PART NUMBER 79366 AYS S-ABA CODE OEM NO
VAN HOOL	2895	BABELSBERGER	4076	BARTOLETTI	2897
J		K		L	
	AYS CODE 581950 PART NUMBER 79367 AYS S-ABA CODE OEM NO		AYS CODE 310200 PART NUMBER 72871 AYS S-ABA CODE 803580 OEM NO 12234		AYS CODE 312970 PART NUMBER 70996 AYS S-ABA CODE OEM NO

	AYS CODE	CASTING	CONTROL UNIT	APPLICATION	SPLINE TEETH	NO of HOLE	H1	H2	H3	H4	H5	H6	H7	BUSHING (mm)	SPLINE TYPE	CONTROL ARM
A	500871	4087	900	VAN HOOL	19	1	152							14	A38x34 DIN 5482	double bent (short; R=65 mm)
B	500880	4088	900	VAN HOOL	10	1	152							14	SAE 1 1/2" 10 C	double bent (short; R=65 mm)
C	500881	4088	900	VAN HOOL	19	1	152							14	A38x34 DIN 5482	double bent (short; R=65 mm)
D	509850	4085	909	VAN HOOL	27	1	152							14	BNA 227	bent
E	578550	2755	778	VAN HOOL	19	1	152							14	A38x34 DIN 5482	double bent (short; R=65 mm)
F	578560	2756	778	VAN HOOL	19	1	152							14	A38x34 DIN 5482	double bent (short; R=65 mm)
G	578770	4077	778	VAN HOOL	19	1	152							14	A38x34 DIN 5482	double bent (short; R=65 mm)
H	578780	4078	778	VAN HOOL	19	1	152							14	A38x34 DIN 5482	double bent (short; R=65 mm)
I	581940	2894	781	VAN HOOL	19	1	200							14	A38x34 DIN 5482	double bent (short; R=65 mm)
J	581950	2895	781	VAN HOOL	19	1	200							14	A38x34 DIN 5482	double bent (short; R=65 mm)
K	310200	4076	570	BABELSBERGER	8	4	250	220	200	170				14	32 UNI 222	bent
L	312970	2897	412	BARTOLETTI	8	3	214	191	168					12,7	32 UNI 222	bent











BATTAGLINO / BOFORS / BOMBARDIER / BOVA / ENASA / BPW

BATTAGLINO	3068	BATTAGLINO	3069	BOFORS	2753
A		B		C	
	AYS CODE 312681 PART NUMBER 79030 AYS S-ABA CODE 801310 OEM NO 4W1225		AYS CODE 312691 PART NUMBER 79031 AYS S-ABA CODE 801315 OEM NO 4W1230		AYS CODE 558530 PART NUMBER 70869 AYS S-ABA CODE OEM NO 4W3780
BOFORS	2754	BOMBARDIER	3226	BOMBARDIER	2771
D		E		F	
	AYS CODE 558540 PART NUMBER 70868 AYS S-ABA CODE OEM NO		AYS CODE 314260 PART NUMBER 72030 AYS S-ABA CODE 800795 OEM NO		AYS CODE 549710 PART NUMBER 72028 AYS S-ABA CODE OEM NO
BOMBARDIER	2772	BOVA	4104	ENASA	2752
G		H		I	
	AYS CODE 549720 PART NUMBER 72029 AYS S-ABA CODE OEM NO		AYS CODE 583040 PART NUMBER 11011 AYS S-ABA CODE 802925 OEM NO		AYS CODE 310600 PART NUMBER 72408 AYS S-ABA CODE 803320 OEM NO 4W3535
BPW	3226	BPW	2752	BPW	3863
J		K		L	
	AYS CODE 230200 PART NUMBER 72947 AYS S-ABA CODE 800815 OEM NO 246392		AYS CODE 301520 PART NUMBER 72448 AYS S-ABA CODE 803200 OEM NO		AYS CODE 312630 PART NUMBER 72879 AYS S-ABA CODE OEM NO 4731469

	AYS CODE	CASTING	CONTROL UNIT	APPLICATION	SPLINE TEETH	NO of HOLE	H1	H2	H3	H4	H5	H6	H7	BUSHING (mm)	SPLINE TYPE	CONTROL ARM
A	312681	3068	412	BATTAGLINO	10	2	180	150						14	SAE 1 1/2" 10 C	bent
B	312691	3069	412	BATTAGLINO	10	2	180	150						x (L1: 14)	SAE 1 1/2" 10 C	bent
C	558530	2753	958	BOFORS	19	1	200							14	A38x34 DIN 5482	bent
D	558540	2754	958	BOFORS	19	1	200							14	A38x34 DIN 5482	bent
E	314260	3226	414	BOMBARDIER	10	1	178							12,7	SAE 1 1/2" 10 C	bent
F	549710	2771	949	BOMBARDIER	10	1	133							12,7	SAE 1 1/2" 10 C	bent
G	549720	2772	949	BOMBARDIER	10	1	133							12,7	SAE 1 1/2" 10 C	bent
H	583040	4104	983	BOVA	10	1	140							14	SAE 1 1/2" 10 C	bent
I	310600	2752	376	ENASA	19	1	180							14	A38x34 DIN 5482	double bent (short; R=65 mm)
J	230200	3226	453	BPW	10	1	180							16	SAE 1 1/2" 10 C	double bent (long; R=100 mm)
K	301520	2752	401	BPW	10	4	210	180	150	120				14	SAE 1 1/2" 10 C	bent
L	312630	3863	412	BPW	10	3	178	152	127					14	SAE 1 1/2" 10 C	bent



BPW

BPW	3863	3864	3864
A		B	
	AYS CODE 312631		AYS CODE 312640
	PART NUMBER 72881		PART NUMBER 72880
	AYS S-ABA CODE		AYS S-ABA CODE
	OEM NO 12192		OEM NO 4731477
BPW	3068	3069	4076
D		E	
	AYS CODE 312680		AYS CODE 312690
	PART NUMBER 72945		PART NUMBER 72946
	AYS S-ABA CODE 801340		AYS S-ABA CODE 801345
	OEM NO		OEM NO
BPW	4076	4076	4076
G		H	
	AYS CODE 320134		AYS CODE 320135
	PART NUMBER 72875		PART NUMBER cs
	AYS S-ABA CODE 800055		AYS S-ABA CODE 803695
	OEM NO KB1005		OEM NO
BPW	4076	4076	4076
J		K	
	AYS CODE 320137		AYS CODE 320138
	PART NUMBER cs		PART NUMBER cs
	AYS S-ABA CODE 800430		AYS S-ABA CODE
	OEM NO		OEM NO
BPW	4076	4076	4076
L			
	AYS CODE 320234		AYS CODE 320234
	PART NUMBER 72876		PART NUMBER 72876
	AYS S-ABA CODE 800055		AYS S-ABA CODE 800055
	OEM NO KB1010		OEM NO KB1010

	AYS CODE	CASTING	CONTROL UNIT	APPLICATION	SPLINE TEETH	NO of HOLE	H1	H2	H3	H4	H5	H6	H7	BUSHING (mm)	SPLINE TYPE	CONTROL ARM
A	312631	3863	412	BPW	10	2	165	135						14	SAE 1 1/2" 10 C	bent
B	312640	3864	412	BPW	10	3	178	152	127					14	SAE 1 1/2" 10 C	bent
C	312641	3864	412	BPW	10	2	165	135						14	SAE 1 1/2" 10 C	bent
D	312680	3068	412	BPW	10	3	198	173	148					14	SAE 1 1/2" 10 C	bent
E	312690	3069	412	BPW	10	3	198	173	148					14	SAE 1 1/2" 10 C	bent
F	320000	4076	633	BPW	10	6	250	180	165	150	135	120		14	SAE 1 1/2" 10 C	bent
G	320134	4076	616	BPW	10	6	250	180	165	150	135	120		14	SAE 1 1/2" 10 C	ays-saddle type
H	320135	4076	616	BPW	10	6	250	180	165	150	135	120		14	SAE 1 1/2" 10 C	ays-saddle type
I	320136	4076	635	BPW	10	6	250	180	165	150	135	120		14	SAE 1 1/2" 10 C	ays-saddle type
J	320137	4076	616	BPW	10	6	250	180	165	150	135	120		14	SAE 1 1/2" 10 C	ays-saddle type
K	320138	4076	616	BPW	10	6	250	180	165	150	135	120		14	SAE 1 1/2" 10 C	ays-saddle type
L	320234	4076	617	BPW	10	6	250	180	165	150	135	120		14	SAE 1 1/2" 10 C	ays-saddle type

BPW	3068	AYS CODE 320500	PART NUMBER 72884	AYS S-ABA CODE 801330	OEM NO 0517456820	BPW	3069	AYS CODE 320600	PART NUMBER 72885	AYS S-ABA CODE 801335	OEM NO 0517456810	BPW	4076	AYS CODE 321200	PART NUMBER 72645	AYS S-ABA CODE 803675	OEM NO 0517482112
BPW	2752	AYS CODE 321300	PART NUMBER 72053	AYS S-ABA CODE 803210	OEM NO 4W1125	BPW	3068	AYS CODE 321400	PART NUMBER 70969	AYS S-ABA CODE 801340	OEM NO 4W1215	BPW	3069	AYS CODE 321500	PART NUMBER 70970	AYS S-ABA CODE 801345	OEM NO 4W1220
BPW	2752	AYS CODE 322520	PART NUMBER 70678	AYS S-ABA CODE 803105	OEM NO	BPW	2752	AYS CODE 322522	PART NUMBER 70678	AYS S-ABA CODE 803105	OEM NO	BPW	3068	AYS CODE 322680	PART NUMBER 70768	AYS S-ABA CODE 801310	OEM NO
BPW	4032	AYS CODE 326320	PART NUMBER 72253	AYS S-ABA CODE 800055	OEM NO KB1105	BPW	4076	AYS CODE 360760	PART NUMBER 72883	AYS S-ABA CODE 800060	OEM NO 0517482802	BPW	4006	AYS CODE 515060	PART NUMBER 72877	AYS S-ABA CODE	OEM NO 0517456710

	AYS CODE	CASTING	CONTROL UNIT	APPLICATION	SPLINE TEETH	NO of HOLE	H1	H2	H3	H4	H5	H6	H7	BUSHING (mm)	SPLINE TYPE	CONTROL ARM
A	320500	3068	891	BPW	10	3	198	173	148					14	SAE 1 1/2" 10 C	double bent (long; R=100 mm)
B	320600	3069	891	BPW	10	3	198	173	148					x (L1: 14)	SAE 1 1/2" 10 C	double bent (long; R=100 mm)
C	321200	4076	511	BPW	10	5	250	180	150	130	110			14 (L1: x)	SAE 1 1/2" 10 C	bent
D	321300	2752	270	BPW	10	4	210	180	150	125				14	SAE 1 1/2" 10 C	double bent (short; R=65 mm)
E	321400	3068	422	BPW	10	3	198	173	148					14	SAE 1 1/2" 10 C	bent
F	321500	3069	422	BPW	10	3	198	173	148					14	SAE 1 1/2" 10 C	bent
G	322520	2752	422	BPW	10	3	180	150	120					14	SAE 1 1/2" 10 C	bent
H	322522	2752	422	BPW	10	3	180	150	120					14	SAE 1 1/2" 10 C	bent
I	322680	3068	422	BPW	10	2	180	150						14	SAE 1 1/2" 10 C	bent
J	326320	4032	426	BPW	10	4	250	180	150	120				14	SAE 1 1/2" 10 C	bent
K	360760	4076	460	BPW	10	6	250	180	165	150	135	120		14	SAE 1 1/2" 10 C	bent
L	515060	4006	915	BPW	10	3	200	176	152					14 (L1: x)	SAE 1 1/2" 10 C	bent



ABA
Automatic Brake Adjuster / Otomatik Fren Ayar Kolu.
S-ABA
(Self Setting) Automatic Brake Adjuster / Tam Otomatik Fren Ayar Kolu.

* CS > Customer Specific / Özel İmalat













PRODUCT PICTURES ARE TAKEN OF REFERENCE FOR CASTING BODIES. ALSO PLEASE IGNORE CONTROL UNIT & ITS POSITION. ÜRÜN FOTOĞRAFLARI GÖVDELER REFERANS ALINARAK YERLEŞTİRİLMİŞTİR. KİLİT VE KİLİT AÇILARINI DİKKATE ALMAYINIZ.

ALL ORIGINAL NUMBERS, MARKS AND MODELS FROM VEHICLE MANUFACTURERS LISTED IN THIS CATALOGUE ARE FOR COMPARISON PURPOSES ONLY AND MAY NOT BE USED IN INVOICES TO VEHICLE OWNERS OR RESELLERS. / ORJINAL ÜRÜN NUMARALARI MÜŞTERİYİ BİLGİLENDİRME VE ÜRÜNE REFERANS AMAÇLI KULLANILMIŞTIR.

BPW / BRITSAB / CBM / CARDI

BPW	4007	BRITSAB	2760	BRITSAB	2761
A		B		C	
	AYS CODE 515070 PART NUMBER 72878 AYS S-ABA CODE OEM NO 0517456720		AYS CODE 471600 PART NUMBER 10714 AYS S-ABA CODE 802240 OEM NO F4003/F		AYS CODE 471610 PART NUMBER 10715 AYS S-ABA CODE 802245 OEM NO F4004/F
CBM	2851	CBM	2852	CBM	2901
D		E		F	
	AYS CODE 302511 PART NUMBER 70800 AYS S-ABA CODE OEM NO 6034002		AYS CODE 302521 PART NUMBER 70799 AYS S-ABA CODE OEM NO 6034001		AYS CODE 357010 PART NUMBER 70926 AYS S-ABA CODE 801185 OEM NO 6034010
CBM	2901	CBM	2902	CBM	2894
G		H		I	
	AYS CODE 357011 PART NUMBER 70928 AYS S-ABA CODE 801180 OEM NO 6034008		AYS CODE 357020 PART NUMBER 70927 AYS S-ABA CODE 801190 OEM NO 6034011		AYS CODE 357940 PART NUMBER 70838 AYS S-ABA CODE OEM NO
CBM	2895	CARDI	2753	CARDI	2754
J		K		L	
	AYS CODE 357950 PART NUMBER 70839 AYS S-ABA CODE OEM NO		AYS CODE 351500 PART NUMBER 79272 AYS S-ABA CODE OEM NO 44016010		AYS CODE 351501 PART NUMBER 79273 AYS S-ABA CODE OEM NO 44016020

	AYS CODE	CASTING	CONTROL UNIT	APPLICATION	SPLINE TEETH	NO of HOLE	H1	H2	H3	H4	H5	H6	H7	BUSHING (mm)	SPLINE TYPE	CONTROL ARM
A	515070	4007	915	BPW	10	3	200	176	152					14 (L1: x)	SAE 1 1/2" 10 C	bent
B	471600	2760	571	BRITSAB	10	1	168							12,7	SAE 1 1/2" 10 C	double bent (medium; R=78 mm)
C	471610	2761	571	BRITSAB	10	1	168							12,7	SAE 1 1/2" 10 C	double bent (medium; R=78 mm)
D	302511	2851	402	CBM	27	1	239							14	BNA 227	bent
E	302521	2852	402	CBM	27	1	239							14	BNA 227	bent
F	357010	2901	257	CBM	27	1	200							16	BNA 227	double bent (medium; R=78 mm)
G	357011	2901	257	CBM	27	1	180							14	BNA 227	double bent (medium; R=78 mm)
H	357020	2902	257	CBM	27	1	200							14	BNA 227	double bent (medium; R=78 mm)
I	357940	2894	257	CBM	27	1	200							14	BNA 227	double bent (medium; R=78 mm)
J	357950	2895	257	CBM	27	1	200							14	BNA 227	double bent (medium; R=78 mm)
K	351500	2753	251	CARDI	8	3	180	155	130					14	32 UNI 222	ays-saddle type
L	351501	2754	251	CARDI	8	3	180	155	130					14	32 UNI 222	ays-saddle type

CARDI	4076	A		AYS CODE 438700 PART NUMBER 79111 AYS S-ABA CODE 803575 OEM NO 44015800
DANA	2753	B		AYS CODE 247530 PART NUMBER 79266 AYS S-ABA CODE OEM NO R2111/F
DANA	2754	C		AYS CODE 247540 PART NUMBER 79265 AYS S-ABA CODE OEM NO R2112/F
DANA	4104	D		AYS CODE 311040 PART NUMBER 72189 AYS S-ABA CODE 802755 OEM NO E1013280
DANA	2752	E		AYS CODE 311520 PART NUMBER 72190 AYS S-ABA CODE 802765 OEM NO E1013274
DANA	2760	F		AYS CODE 327600 PART NUMBER 70893 AYS S-ABA CODE 802060 OEM NO X1811183
DANA	2761	G		AYS CODE 327610 PART NUMBER 70894 AYS S-ABA CODE 802065 OEM NO X1811184
DANA	2752	H		AYS CODE 362520 PART NUMBER 72144 AYS S-ABA CODE 803045 OEM NO
MCW	4104	I		AYS CODE 260900 PART NUMBER 70859 AYS S-ABA CODE 802905 OEM NO KB2325
MCW	4104	J		AYS CODE 311040 PART NUMBER 72189 AYS S-ABA CODE 802755 OEM NO E1013280
MCW	2752	K		AYS CODE 311520 PART NUMBER 72190 AYS S-ABA CODE 802765 OEM NO E1013274
MCW	2760	L		AYS CODE 327600 PART NUMBER 70893 AYS S-ABA CODE 802060 OEM NO X1811183

	AYS CODE	CASTING	CONTROL UNIT	APPLICATION	SPLINE TEETH	NO of HOLE	H1	H2	H3	H4	H5	H6	H7	BUSHING (mm)	SPLINE TYPE	CONTROL ARM
A	438700	4076	738	CARDI	8	6	250	180	165	150	135	120		14	32 UNI 222	ays-saddle type
B	247530	2753	147	DANA	10	1	140							12,7	SAE 1 1/2" 10 C	double bent (medium; R=78 mm)
C	247540	2754	147	DANA	10	1	140							12,7	SAE 1 1/2" 10 C	double bent (medium; R=78 mm)
D	311040	4104	411	DANA	10	1	108							12,7	SAE 1 1/2" 10 C	bent
E	311520	2752	411	DANA	10	1	114							12,7	SAE 1 1/2" 10 C	bent
F	327600	2760	427	DANA	10	1	140							12,7	SAE 1 1/2" 10 C	bent
G	327610	2761	427	DANA	10	1	140							12,7	SAE 1 1/2" 10 C	bent
H	362520	2752	262	DANA	10	1	165							12,7	SAE 1 1/2" 10 C	double bent (medium; R=78 mm)
I	260900	4104	427	MCW	10	1	140							12,7	SAE 1 1/2" 10 C	bent
J	311040	4104	411	MCW	10	1	108							12,7	SAE 1 1/2" 10 C	bent
K	311520	2752	411	MCW	10	1	114							12,7	SAE 1 1/2" 10 C	bent
L	327600	2760	427	MCW	10	1	140							12,7	SAE 1 1/2" 10 C	bent



MCW / NEOPLAN

A	MCW	2760	AYS CODE 327601	PART NUMBER 72140	AYS S-ABA CODE 802210	OEM NO R8918/F	B	MCW	2761	AYS CODE 327610	PART NUMBER 70894	AYS S-ABA CODE 802065	OEM NO X1811184	C	MCW	2761	AYS CODE 327611	PART NUMBER 72141	AYS S-ABA CODE 802215	OEM NO R8919/F
D	MCW	3185	AYS CODE 327850	PART NUMBER 70930	AYS S-ABA CODE 801765	OEM NO X2210967	E	MCW	3186	AYS CODE 327860	PART NUMBER 70931	AYS S-ABA CODE 801770	OEM NO X2210966	F	MCW	2752	AYS CODE 362520	PART NUMBER 72144	AYS S-ABA CODE 803045	OEM NO
G	MCW	3195	AYS CODE 370000	PART NUMBER 72452	AYS S-ABA CODE	OEM NO R9139/F	H	MCW	3196	AYS CODE 370100	PART NUMBER 72453	AYS S-ABA CODE	OEM NO F9141/F	I	MCW	2760	AYS CODE 587600	PART NUMBER 72147	AYS S-ABA CODE 802060	OEM NO R8744/F
J	MCW	2761	AYS CODE 587610	PART NUMBER 72148	AYS S-ABA CODE 802065	OEM NO R8745/F	K	MCW	4104	AYS CODE 590040	PART NUMBER 72361	AYS S-ABA CODE 802785	OEM NO X2052967	L	NEOPLAN	3863	AYS CODE 210800	PART NUMBER 72203	AYS S-ABA CODE	OEM NO B510643

	AYS CODE	CASTING	CONTROL UNIT	APPLICATION	SPLINE TEETH	NO of HOLE	H1	H2	H3	H4	H5	H6	H7	BUSHING (mm)	SPLINE TYPE	CONTROL ARM
A	327601	2760	427	MCW	10	1	165							12,7	SAE 1 1/2" 10 C	bent
B	327610	2761	427	MCW	10	1	140							12,7	SAE 1 1/2" 10 C	bent
C	327611	2761	427	MCW	10	1	165							12,7	SAE 1 1/2" 10 C	bent
D	327850	3185	427	MCW	10	1	140							12,7	SAE 1 1/2" 10 C	bent
E	327860	3186	427	MCW	10	1	140							12,7	SAE 1 1/2" 10 C	bent
F	362520	2752	262	MCW	10	1	165							12,7	SAE 1 1/2" 10 C	double bent (medium; R=78 mm)
G	370000	3195	911	MCW	10	1	115							12,7	SAE 1 1/2" 10 C	bent
H	370100	3196	911	MCW	10	1	115							12,7	SAE 1 1/2" 10 C	bent
I	587600	2760	987	MCW	10	1	140							12,7	SAE 1 1/2" 10 C	bent
J	587610	2761	987	MCW	10	1	140							12,7	SAE 1 1/2" 10 C	bent
K	590040	4104	990	MCW	10	1	115							12,7	SAE 1 1/2" 10 C	bent
L	210800	3863	778	NEOPLAN	19	1	145							14	A38x34 DIN 5482	double bent (short; R=65 mm)

NEOPLAN	3864	NEOPLAN	3202	NEOPLAN	3078
A		B		C	
	AYS CODE 210900 PART NUMBER 72204 AYS S-ABA CODE OEM NO B510642		AYS CODE 210905 PART NUMBER 72177 AYS S-ABA CODE 801840 OEM NO 4W2845		AYS CODE 250100 PART NUMBER 70706 AYS S-ABA CODE 801560 OEM NO KB2440
NEOPLAN	3202	NEOPLAN	3162	NEOPLAN	3195
D		E		F	
	AYS CODE 250200 PART NUMBER 70775 AYS S-ABA CODE 801850 OEM NO KB2100		AYS CODE 283700 PART NUMBER 70753 AYS S-ABA CODE 801720 OEM NO KB2445		AYS CODE 290200 PART NUMBER 70772 AYS S-ABA CODE OEM NO 4W3125
NEOPLAN	3196	NEOPLAN	4036	DENNIS	4104
G		H		I	
	AYS CODE 290300 PART NUMBER 70771 AYS S-ABA CODE OEM NO 4W3130		AYS CODE 377360 PART NUMBER 72212 AYS S-ABA CODE OEM NO KB2720		AYS CODE 260900 PART NUMBER 70859 AYS S-ABA CODE 802905 OEM NO KB2325
DENNIS	4104	DENNIS	2760	DENNIS	2761
J		K		L	
	AYS CODE 310040 PART NUMBER 72393 AYS S-ABA CODE 802915 OEM NO KB2865		AYS CODE 357600 PART NUMBER 10937 AYS S-ABA CODE 802040 OEM NO R9025/F		AYS CODE 357610 PART NUMBER 10938 AYS S-ABA CODE 802045 OEM NO R9024/F











	AYS CODE	CASTING	CONTROL UNIT	APPLICATION	SPLINE TEETH	NO of HOLE	H1	H2	H3	H4	H5	H6	H7	BUSHING (mm)	SPLINE TYPE	CONTROL ARM
A	210900	3864	778	NEOPLAN	19	1	145							14	A38x34 DIN 5482	double bent (short; R=65 mm)
B	210905	3202	295	NEOPLAN	19	1	130							14	A38x34 DIN 5482	double bent (short; R=65 mm)
C	250100	3078	854	NEOPLAN	26	1	115							14	N42x1.5x9H DIN 5480	double bent (short; R=65 mm)
D	250200	3202	864	NEOPLAN	26	1	130							14	N42x1.5x9H DIN 5480	double bent (short; R=65 mm)
E	283700	3162	253	NEOPLAN	26	1	145							14	N42x1.5x9H DIN 5480	double bent (medium; R=78 mm)
F	290200	3195	255	NEOPLAN	26	1	115							14	N42x1.5x9H DIN 5480	double bent (medium; R=78 mm)
G	290300	3196	255	NEOPLAN	26	1	115							14	N42x1.5x9H DIN 5480	double bent (medium; R=78 mm)
H	377360	4036	477	NEOPLAN	26	1	130							14	N42x1.5x9H DIN 5480	double bent (medium; R=78 mm)
I	260900	4104	427	DENNIS	10	1	140							12,7	SAE 1 1/2" 10 C	bent
J	310040	4104	410	DENNIS	10	1	140							12,7	SAE 1 1/2" 10 C	bent
K	357600	2760	257	DENNIS	10	1	140							12,7	SAE 1 1/2" 10 C	double bent (medium; R=78 mm)
L	357610	2761	257	DENNIS	10	1	140							12,7	SAE 1 1/2" 10 C	double bent (medium; R=78 mm)



DENNIS

DENNIS	4104	DENNIS	4104	DENNIS	2760
A	 AYS CODE 365040 PART NUMBER 72364 AYS S-ABA CODE 802830 OEM NO KB2375	B	 AYS CODE 365041 PART NUMBER 72644 AYS S-ABA CODE 802900 OEM NO F4419/F	C	 AYS CODE 365600 PART NUMBER 79156 AYS S-ABA CODE 802180 OEM NO F4714/F
DENNIS	2761	DENNIS	4104	DENNIS	3068
D	 AYS CODE 365610 PART NUMBER 79157 AYS S-ABA CODE 802185 OEM NO F4715/F	E	 AYS CODE 368040 PART NUMBER 70986 AYS S-ABA CODE 802900 OEM NO R8538/F	F	 AYS CODE 492680 PART NUMBER 79170 AYS S-ABA CODE 801200 OEM NO R9990/F
DENNIS	3069	DENNIS	4104	DENNIS	4104
G	 AYS CODE 492690 PART NUMBER 79171 AYS S-ABA CODE 801205 OEM NO R9991/F	H	 AYS CODE 502040 PART NUMBER 72362 AYS S-ABA CODE 802840 OEM NO FL932/004	I	 AYS CODE 502041 PART NUMBER 72367 AYS S-ABA CODE 802915 OEM NO ES8550578
DENNIS	4104	DENNIS	4104	DENNIS	2752
J	 AYS CODE 502042 PART NUMBER 10939 AYS S-ABA CODE 802790 OEM NO 651630	K	 AYS CODE 585040 PART NUMBER 72145 AYS S-ABA CODE 802840 OEM NO ES8550903	L	 AYS CODE 585520 PART NUMBER 72363 AYS S-ABA CODE 802915 OEM NO

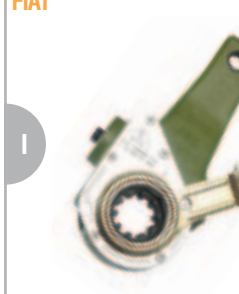

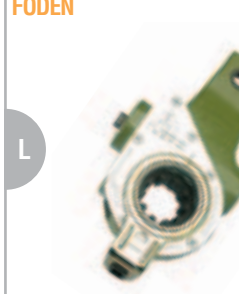







	AYS CODE	CASTING	CONTROL UNIT	APPLICATION	SPLINE TEETH	NO of HOLE	H1	H2	H3	H4	H5	H6	H7	BUSHING (mm)	SPLINE TYPE	CONTROL ARM
A	365040	4104	365	DENNIS	10	1	127							12,7	SAE 1 1/2" 10 C	double bent (medium; R=78 mm)
B	365041	4104	365	DENNIS	10	1	140							12,7	SAE 1 1/2" 10 C	double bent (medium; R=78 mm)
C	365600	2760	265	DENNIS	10	1	165							12,7	SAE 1 1/2" 10 C	double bent (medium; R=78 mm)
D	365610	2761	265	DENNIS	10	1	165							12,7	SAE 1 1/2" 10 C	double bent (medium; R=78 mm)
E	368040	4104	268	DENNIS	10	1	140							12,7	SAE 1 1/2" 10 C	double bent (medium; R=78 mm)
F	492680	3068	592	DENNIS	10	1	140							12,7	SAE 1 1/2" 10 C	double bent (medium; R=78 mm)
G	492690	3069	592	DENNIS	10	1	140							12,7	SAE 1 1/2" 10 C	double bent (medium; R=78 mm)
H	502040	4104	902	DENNIS	10	1	127							12,7	SAE 1 1/2" 10 C	bent
I	502041	4104	902	DENNIS	10	1	140							12,7	SAE 1 1/2" 10 C	bent
J	502042	4104	902	DENNIS	10	1	115							12,7	SAE 1 1/2" 10 C	bent
K	585040	4104	985	DENNIS	10	1	127							12,7	SAE 1 1/2" 10 C	bent
L	585520	2752	985	DENNIS	10	1	140							12,7	SAE 1 1/2" 10 C	bent

DENNIS	2760	DENNIS	2761	FIAT	2851
A		B		C	
	AYS CODE 587600 PART NUMBER 72147 AYS S-ABA CODE 802060 OEM NO R8744/F		AYS CODE 587610 PART NUMBER 72148 AYS S-ABA CODE 802065 OEM NO R8745/F		AYS CODE 331510 PART NUMBER 72033 AYS S-ABA CODE OEM NO 4W3475
FIAT	2852	FIAT	3890	FIAT	4086
D		E		F	
	AYS CODE 331520 PART NUMBER 72034 AYS S-ABA CODE OEM NO 4W3470		AYS CODE 332900 PART NUMBER 72035 AYS S-ABA CODE OEM NO 4W3465		AYS CODE 478860 PART NUMBER 70892 AYS S-ABA CODE 803570 OEM NO 4W3380
FIAT	2752	FIAT	4085	FIAT	4085
G		H		I	
	AYS CODE 565520 PART NUMBER 70891 AYS S-ABA CODE 802730 OEM NO 4W3060		AYS CODE 565851 PART NUMBER 70810 AYS S-ABA CODE 802725 OEM NO 4W2745		AYS CODE 567851 PART NUMBER 70809 AYS S-ABA CODE 802725 OEM NO 4W3160
FODEN	3226	FODEN	2752	FODEN	4104
J		K		L	
	AYS CODE 276261 PART NUMBER 79461 AYS S-ABA CODE 800905 OEM NO AT79461		AYS CODE 314526 PART NUMBER 79169 AYS S-ABA CODE 802915 OEM NO FL932005		AYS CODE 327041 PART NUMBER 72457 AYS S-ABA CODE 802905 OEM NO Y03277102

	AYS CODE	CASTING	CONTROL UNIT	APPLICATION	SPLINE TEETH	NO of HOLE	H1	H2	H3	H4	H5	H6	H7	BUSHING (mm)	SPLINE TYPE	CONTROL ARM
A	587600	2760	987	DENNIS	10	1	140							12,7	SAE 1 1/2" 10 C	bent
B	587610	2761	987	DENNIS	10	1	140							12,7	SAE 1 1/2" 10 C	bent
C	331510	2851	431	FIAT	8	1	218							12,7	32 UNI 222	double bent (medium; R=78 mm)
D	331520	2852	431	FIAT	8	1	218							12,7	32 UNI 222	double bent (medium; R=78 mm)
E	332900	3890	432	FIAT	8	1	190							12,7	32 UNI 222	double bent (medium; R=78 mm)
F	478860	4086	578	FIAT	8	1	180							12,7	32 UNI 222	double bent (short; R=65 mm)
G	565520	2752	865	FIAT	8	1	170							12,7	32 UNI 222	double bent (short; R=65 mm)
H	565851	4085	865	FIAT	8	1	160							12,7	32 UNI 222	double bent (short; R=65 mm)
I	567851	4085	867	FIAT	8	1	160							12,7	32 UNI 222	double bent (short; R=65 mm)
J	276261	3226	176	FODEN	28	1	140							12,7	SAE 1 1/2" 28 C	double bent (medium; R=78 mm)
K	314526	2752	414	FODEN	10	1	140							12,7	SAE 1 1/2" 10 C	bent
L	327041	4104	427	FODEN	10	1	140							12,7	SAE 1 1/2" 10 C	bent



FODEN

A	FODEN	3185		AYS CODE 330000 PART NUMBER 72937 AYS S-ABA CODE 801825 OEM NO 1465301021
B	FODEN	3186		AYS CODE 330100 PART NUMBER 72938 AYS S-ABA CODE 801830 OEM NO 1465301011
C	FODEN	3226		AYS CODE 330200 PART NUMBER 72864 AYS S-ABA CODE 800895 OEM NO 2700039000
D	FODEN	3226		AYS CODE 330300 PART NUMBER 72180 AYS S-ABA CODE 800885 OEM NO XH72180/C
E	FODEN	3226		AYS CODE 330400 PART NUMBER 72199 AYS S-ABA CODE 800885 OEM NO XH72199/C
F	FODEN	3226		AYS CODE 330500 PART NUMBER 79184 AYS S-ABA CODE 800890 OEM NO XH79184/C
G	FODEN	3704		AYS CODE 330600 PART NUMBER 79349 AYS S-ABA CODE 801885 OEM NO
H	FODEN	3705		AYS CODE 330700 PART NUMBER 79350 AYS S-ABA CODE 801890 OEM NO
I	FODEN	3226		AYS CODE 354260 PART NUMBER 72179 AYS S-ABA CODE 800725 OEM NO 4W3775
J	FODEN	3226		AYS CODE 357263 PART NUMBER 72181 AYS S-ABA CODE 800895 OEM NO XH72181/C
K	FODEN	3226		AYS CODE 357264 PART NUMBER 79682 AYS S-ABA CODE 800910 OEM NO
L	FODEN	4085		AYS CODE 362850 PART NUMBER 72568 AYS S-ABA CODE 803045 OEM NO F4211/F

	AYS CODE	CASTING	CONTROL UNIT	APPLICATION	SPLINE TEETH	NO of HOLE	H1	H2	H3	H4	H5	H6	H7	BUSHING (mm)	SPLINE TYPE	CONTROL ARM
A	330000	3185	787	FODEN	26	1	145							14	N42x1.5x9H DIN 5480	double bent (short; R=65 mm)
B	330100	3186	787	FODEN	26	1	145							14	N42x1.5x9H DIN 5480	double bent (short; R=65 mm)
C	330200	3226	731	FODEN	28	1	140							12,7	SAE 1 1/2" 28 C	double bent (long; R=100 mm)
D	330300	3226	357	FODEN	28	1	127							12,7	SAE 1 1/2" 28 C	double bent (long; R=100 mm)
E	330400	3226	362	FODEN	28	1	127							12,7	SAE 1 1/2" 28 C	double bent (long; R=100 mm)
F	330500	3226	176	FODEN	28	1	127							12,7	SAE 1 1/2" 28 C	double bent (medium; R=78 mm)
G	330600	3704	385	FODEN	10	1	165							14	SAE 1 1/2" 10 C	double bent (short; R=65 mm)
H	330700	3705	385	FODEN	10	1	165							14	SAE 1 1/2" 10 C	double bent (short; R=65 mm)
I	354260	3226	354	FODEN	10	1	127							12,7	SAE 1 1/2" 10 C	double bent (long; R=100 mm)
J	357263	3226	357	FODEN	28	1	140							12,7	SAE 1 1/2" 28 C	double bent (long; R=100 mm)
K	357264	3226	357	FODEN	28	1	143							14	SAE 1 1/2" 28 C	double bent (long; R=100 mm)
L	362850	4085	262	FODEN	10	1	165							12,7	SAE 1 1/2" 10 C	double bent (medium; R=78 mm)

FODEN	3226	FODEN	2760	FODEN	2761
A		B		C	
	AYS CODE 431260 PART NUMBER 12132 AYS S-ABA CODE 800885 OEM NO XH12132C		AYS CODE 492600 PART NUMBER 72417 AYS S-ABA CODE 802180 OEM NO Y03280904		AYS CODE 492610 PART NUMBER 72418 AYS S-ABA CODE 802185 OEM NO F4239F
FODEN	4104	FODEN	4086	FODEN	4086
D		E		F	
	AYS CODE 503040 PART NUMBER 72333 AYS S-ABA CODE 800275 OEM NO 4W3100		AYS CODE 563861 PART NUMBER 72939 AYS S-ABA CODE 803735 OEM NO XH72939/C		AYS CODE 563862 PART NUMBER 79133 AYS S-ABA CODE 803740 OEM NO XH79133/C
FRUEHAUF	2752	FRUEHAUF	2752	FRUEHAUF	2752
G		H		I	
	AYS CODE 314523 PART NUMBER 70979 AYS S-ABA CODE 803550 OEM NO		AYS CODE 314524 PART NUMBER 72031 AYS S-ABA CODE 803145 OEM NO		AYS CODE 314525 PART NUMBER 72103 AYS S-ABA CODE 803150 OEM NO CF351148
FRUEHAUF	4086	FRUEHAUF	4086	FRUEHAUF	2752
J		K		L	
	AYS CODE 326863 PART NUMBER 72267 AYS S-ABA CODE 800075 OEM NO CF351902		AYS CODE 326864 PART NUMBER 72268 AYS S-ABA CODE 803655 OEM NO Y537146		AYS CODE 340000 PART NUMBER CS AYS S-ABA CODE 802960 OEM NO







	AYS CODE	CASTING	CONTROL UNIT	APPLICATION	SPLINE TEETH	NO of HOLE	H1	H2	H3	H4	H5	H6	H7	BUSHING (mm)	SPLINE TYPE	CONTROL ARM
A	431260	3226	731	FODEN	28	1	127							12,7	SAE 1 1/2" 28 C	double bent (long; R=100 mm)
B	492600	2760	592	FODEN	10	1	165							12,7	SAE 1 1/2" 10 C	double bent (medium; R=78 mm)
C	492610	2761	592	FODEN	10	1	165							12,7	SAE 1 1/2" 10 C	double bent (medium; R=78 mm)
D	503040	4104	903	FODEN	10	1	140							12,7	SAE 1 1/2" 10 C	bent
E	563861	4086	963	FODEN	28	1	127							12,7	SAE 1 1/2" 28 C	bent
F	563862	4086	963	FODEN	28	1	140							12,7	SAE 1 1/2" 28 C	bent
G	314523	2752	414	FRUEHAUF	37	4	203	178	152	127				12.7 (L1: x)	SAE J 498	bent
H	314524	2752	414	FRUEHAUF	10	3	200	142	118					12,7	SAE 1 1/2" 10 C	bent
I	314525	2752	414	FRUEHAUF	10	3	200	142	118					14	SAE 1 1/2" 10 C	bent
J	326863	4086	426	FRUEHAUF	10	4	215	153	129	105				14 (L1: 16)	SAE 1 1/2" 10 C	bent
K	326864	4086	426	FRUEHAUF	10	5	215	181	153	129	105			12,7	SAE 1 1/2" 10 C	bent
L	340000	2752	954	FRUEHAUF	10	1	150							14	SAE 1 1/2" 10 C	bent

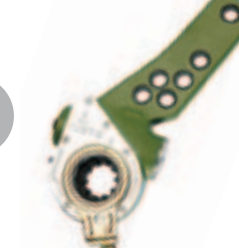

FRUEHAUF / GIGANT / SAE

A	FRUEHAUF	4086		AYS CODE 432860 PART NUMBER 72266 AYS S-ABA CODE 800065 OEM NO
B	FRUEHAUF	4076		AYS CODE 435763 PART NUMBER CS AYS S-ABA CODE OEM NO
C	FRUEHAUF	4086		AYS CODE 435802 PART NUMBER 79022 AYS S-ABA CODE 800065 OEM NO TP02003007X
D	FRUEHAUF	2752		AYS CODE 491520 PART NUMBER 70959 AYS S-ABA CODE 803560 OEM NO
E	FRUEHAUF	4086		AYS CODE 505860 PART NUMBER 72104 AYS S-ABA CODE 803760 OEM NO 4W1165
F	FRUEHAUF	2752		AYS CODE 519521 PART NUMBER 72115 AYS S-ABA CODE 803145 OEM NO
G	FRUEHAUF	2752		AYS CODE 568520 PART NUMBER 70854 AYS S-ABA CODE 803555 OEM NO
H	GIGANT	3069		AYS CODE 274690 PART NUMBER 79270 AYS S-ABA CODE 800295 OEM NO 9002222
I	SAE	2901		AYS CODE 248010 PART NUMBER 79138 AYS S-ABA CODE 800955 OEM NO 09002209
J	SAE	2902		AYS CODE 248020 PART NUMBER 79139 AYS S-ABA CODE 800960 OEM NO 09002210
K	SAE	2771		AYS CODE 248710 PART NUMBER 79146 AYS S-ABA CODE OEM NO 9002233
L	SAE	2772		AYS CODE 248720 PART NUMBER 79147 AYS S-ABA CODE OEM NO 9002234



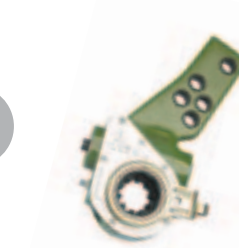









	AYS CODE	CASTING	CONTROL UNIT	APPLICATION	SPLINE TEETH	NO of HOLE	H1	H2	H3	H4	H5	H6	H7	BUSHING (mm)	SPLINE TYPE	CONTROL ARM
A	432860	4086	632	FRUEHAUF	37	4	215	153	129	105				14 (L1: 16)	SAE J 498	bent
B	435763	4076	635	FRUEHAUF	37	2	152	127						14	SAE J 498	ays-saddle type
C	435802	4086	635	FRUEHAUF	37	4	215	153	129	105				14 (L1: 16)	SAE J 498	ays-saddle type
D	491520	2752	691	FRUEHAUF	37	4	210	180	155	130				14 (L1: x)	SAE J 498	double bent (short; R=65 mm)
E	505860	4086	905	FRUEHAUF	37	4	210	153	129	105				14	SAE J 498	bent
F	519521	2752	919	FRUEHAUF	10	3	200	142	118					12,7	SAE 1 1/2" 10 C	bent
G	568520	2752	868	FRUEHAUF	37	4	210	180	150	125				14 (L1: x)	SAE J 498	double bent (short; R=65 mm)
H	274690	3069	174	GIGANT	10	1	165							14	SAE 1 1/2" 10 C	double bent (short; R=65 mm)
I	248010	2901	148	SAE	10	2	178	153						14	SAE 1 1/2" 10 C	double bent (short; R=65 mm)
J	248020	2902	148	SAE	10	2	178	153						14	SAE 1 1/2" 10 C	double bent (short; R=65 mm)
K	248710	2771	148	SAE	10	2	178	153						14	SAE 1 1/2" 10 C	double bent (short; R=65 mm)
L	248720	2772	148	SAE	10	2	178	153						14	SAE 1 1/2" 10 C	double bent (short; R=65 mm)

SAE	4097	SAE	3069	SAE	3068
A		B		C	
	AYS CODE 248970 PART NUMBER 79148 AYS S-ABA CODE 803600 OEM NO 9002281		AYS CODE 250690 PART NUMBER 79145 AYS S-ABA CODE 801305 OEM NO 9002225		AYS CODE 274680 PART NUMBER 79269 AYS S-ABA CODE 800300 OEM NO 9002221
SAE	3069	SAE	4086	SAE	4076
D		E		F	
	AYS CODE 274690 PART NUMBER 79270 AYS S-ABA CODE 800295 OEM NO 9002222		AYS CODE 326860 PART NUMBER 72251 AYS S-ABA CODE 803725 OEM NO 4W1035		AYS CODE 351700 PART NUMBER 79149 AYS S-ABA CODE 800070 OEM NO 09002113
SAE	3226	SAE	3068	SAE	2901
G		H		I	
	AYS CODE 374260 PART NUMBER 72837 AYS S-ABA CODE 800810 OEM NO 09012061		AYS CODE 410000 PART NUMBER 79144 AYS S-ABA CODE 801300 OEM NO 9002224		AYS CODE 414010 PART NUMBER 72869 AYS S-ABA CODE 800975 OEM NO 9002201
SAE	2902	SAE	4076	SAE	4097
J		K		L	
	AYS CODE 414020 PART NUMBER 72870 AYS S-ABA CODE 800980 OEM NO 9002202		AYS CODE 417701 PART NUMBER 79649 AYS S-ABA CODE 800270 OEM NO 9319035		AYS CODE 451970 PART NUMBER 79542 AYS S-ABA CODE 800070 OEM NO 9319179

	AYS CODE	CASTING	CONTROL UNIT	APPLICATION	SPLINE TEETH	NO of HOLE	H1	H2	H3	H4	H5	H6	H7	BUSHING (mm)	SPLINE TYPE	CONTROL ARM
A	248970	4097	148	SAE	10	3	178	153	127					14	SAE 1 1/2" 10 C	double bent (short; R=65 mm)
B	250690	3069	250	SAE	10	2	178	153						x (L1: 14)	SAE 1 1/2" 10 C	double bent (short; R=65 mm)
C	274680	3068	174	SAE	10	1	165							14	SAE 1 1/2" 10 C	double bent (short; R=65 mm)
D	274690	3069	174	SAE	10	1	165							14	SAE 1 1/2" 10 C	double bent (short; R=65 mm)
E	326860	4086	426	SAE	27	4	210	180	150	125				14	BNA 227	bent
F	351700	4076	251	SAE	10	6	250	180	155	140	125	105		14	SAE 1 1/2" 10 C	ays-saddle type
G	374260	3226	374	SAE	10	2	178	153						14	SAE 1 1/2" 10 C	double bent (short; R=65 mm)
H	410000	3068	250	SAE	10	2	178	153						14	SAE 1 1/2" 10 C	double bent (short; R=65 mm)
I	414010	2901	614	SAE	10	2	180	150						14	SAE 1 1/2" 10 C	double bent (short; R=65 mm)
J	414020	2902	614	SAE	10	2	180	150						14	SAE 1 1/2" 10 C	double bent (short; R=65 mm)
K	417701	4076	617	SAE	10	7	250	180	165	150	135	120	105	14	SAE 1 1/2" 10 C	ays-saddle type
L	451970	4097	251	SAE	10	5	180	155	140	125	105			14	SAE 1 1/2" 10 C	ays-saddle type



SAE / GORICA / GKN / GRAZIANO / HYUNDAI

SAE	2752	SAE	2901	SAE	2902
A		B		C	
	AYS CODE 493520 PART NUMBER 70804 AYS S-ABA CODE 803205 OEM NO		AYS CODE 566010 PART NUMBER 72751 AYS S-ABA CODE 800965 OEM NO 9002153		AYS CODE 566020 PART NUMBER 72752 AYS S-ABA CODE 800970 OEM NO 9002154
GORICA	4032	GKN	2760	GKN	2761
D		E		F	
	AYS CODE 411320 PART NUMBER 72733 AYS S-ABA CODE 803585 OEM NO		AYS CODE 247600 PART NUMBER 79158 AYS S-ABA CODE 802160 OEM NO F4706/F		AYS CODE 247610 PART NUMBER 79159 AYS S-ABA CODE 802165 OEM NO F4707/F
GKN	4085	GRAZIANO	2753	GRAZIANO	2754
G		H		I	
	AYS CODE 384850 PART NUMBER 79696 AYS S-ABA CODE 803025 OEM NO 4W3435		AYS CODE 374530 PART NUMBER 79064 AYS S-ABA CODE OEM NO 4W3745		AYS CODE 374540 PART NUMBER 79063 AYS S-ABA CODE OEM NO 4W3750
HYUNDAI	3226	HYUNDAI	4004	HYUNDAI	4005
J		K		L	
	AYS CODE 504260 PART NUMBER 72777 AYS S-ABA CODE 800730 OEM NO		AYS CODE 594040 PART NUMBER 72772 AYS S-ABA CODE OEM NO		AYS CODE 595050 PART NUMBER 72773 AYS S-ABA CODE OEM NO

	AYS CODE	CASTING	CONTROL UNIT	APPLICATION	SPLINE TEETH	NO of HOLE	H1	H2	H3	H4	H5	H6	H7	BUSHING (mm)	SPLINE TYPE	CONTROL ARM
A	493520	2752	693	SAE	10	4	210	180	150	120				14	SAE 1 1/2" 10 C	double bent (short; R=65 mm)
B	566010	2901	966	SAE	10	2	180	150						14	SAE 1 1/2" 10 C	bent
C	566020	2902	966	SAE	10	2	180	150						14	SAE 1 1/2" 10 C	bent
D	411320	4032	611	GORICA	8	4	250	180	155	125				14	32 UNI 222	bent
E	247600	2760	147	GKN	10	1	152							12,7	SAE 1 1/2" 10 C	double bent (medium; R=78 mm)
F	247610	2761	147	GKN	10	1	152							12,7	SAE 1 1/2" 10 C	double bent (medium; R=78 mm)
G	384850	4085	284	GKN	10	2	155	127						12,7	SAE 1 1/2" 10 C	bent
H	374530	2753	374	GRAZIANO	19	1	150							14	A38x34 DIN 5482	double bent (short; R=65 mm)
I	374540	2754	374	GRAZIANO	19	1	150							14	A38x34 DIN 5482	double bent (short; R=65 mm)
J	504260	3226	704	HYUNDAI	10	1	135							16	SAE 1 1/2" 10 C	double bent (short; R=65 mm)
K	594040	4004	894	HYUNDAI	10	1	145							14	SAE 1 1/2" 10 C	double bent (short; R=65 mm)
L	595050	4005	895	HYUNDAI	10	1	145							14	SAE 1 1/2" 10 C	double bent (short; R=65 mm)

HINO	2760	HINO	2761	HINO	2752
A		B		C	
	AYS CODE 264600 PART NUMBER 12254 AYS S-ABA CODE 802340 OEM NO 4W2405		AYS CODE 264610 PART NUMBER 12255 AYS S-ABA CODE 802345 OEM NO 4W2410		AYS CODE 310800 PART NUMBER 12256 AYS S-ABA CODE 803280 OEM NO 4W2415
IKARUS	3226	IKARUS	4097	IKARUS	3717
D		E		F	
	AYS CODE 310100 PART NUMBER 72778 AYS S-ABA CODE 800770 OEM NO		AYS CODE 420970 PART NUMBER 72853 AYS S-ABA CODE 800140 OEM NO 4W3020		AYS CODE 571170 PART NUMBER 12363 AYS S-ABA CODE 801925 OEM NO
IKARUS	3718	JELE CZ	4104	JELTZ	4046
G		H		I	
	AYS CODE 571180 PART NUMBER 12364 AYS S-ABA CODE 801930 OEM NO		AYS CODE 546040 PART NUMBER 70726 AYS S-ABA CODE 803255 OEM NO 1021029692945		AYS CODE 287460 PART NUMBER 79283 AYS S-ABA CODE OEM NO 1021029692521
JELTZ	4047	JELTZ	4032	JELTZ	2755
J		K		L	
	AYS CODE 287470 PART NUMBER 79282 AYS S-ABA CODE OEM NO 1021029692522		AYS CODE 415320 PART NUMBER 12356 AYS S-ABA CODE 803705 OEM NO		AYS CODE 436550 PART NUMBER 12313 AYS S-ABA CODE 800635 OEM NO 1021029692517

	AYS CODE	CASTING	CONTROL UNIT	APPLICATION	SPLINE TEETH	NO of HOLE	H1	H2	H3	H4	H5	H6	H7	BUSHING (mm)	SPLINE TYPE	CONTROL ARM
A	264600	2760	164	HINO	19	1	150							12,7	A38x34 DIN 5482	bent
B	264610	2761	164	HINO	19	1	150							12,7	A38x34 DIN 5482	bent
C	310800	2752	424	HINO	19	1	150							12,7	A38x34 DIN 5482	bent
D	310100	3226	704	IKARUS	10	1	145							16	SAE 1 1/2" 10 C	double bent (short; R=65 mm)
E	420970	4097	720	IKARUS	20	2	175	155						14	A40x36 DIN 5482	bent
F	571170	3717	771	IKARUS	19	1	165							14	A38x34 DIN 5482	double bent (short; R=65 mm)
G	571180	3718	771	IKARUS	19	1	165							14	A38x34 DIN 5482	double bent (short; R=65 mm)
H	546040	4104	946	JELE CZ	19	1	122							14	A38x34 DIN 5482	bent
I	287460	4046	187	JELTZ	27	1	135							14	BNA 227 D3.5	double bent (short; R=65 mm)
J	287470	4047	187	JELTZ	27	1	135							14	BNA 227 D3.5	double bent (short; R=65 mm)
K	415320	4032	515	JELTZ	19	1	130							14	A38x34 DIN 5482	bent
L	436550	2755	636	JELTZ	27	1	180							14	BNA 227 D3.5	bent















JELTZ / KÄLBLE / KAMAZ

JELTZ	2756	JELTZ	3226	JELTZ	4079
A		B		C	
	AYS CODE 436560 PART NUMBER 12314 AYS S-ABA CODE 800640 OEM NO 1021029692518		AYS CODE 448260 PART NUMBER 12310 AYS S-ABA CODE 800880 OEM NO		AYS CODE 577790 PART NUMBER 12311 AYS S-ABA CODE OEM NO 1021029692516
JELTZ	4080	KÄLBLE	4085	KÄLBLE	3717
D		E		F	
	AYS CODE 577800 PART NUMBER 12312 AYS S-ABA CODE OEM NO 1021029692515		AYS CODE 304850 PART NUMBER 72205 AYS S-ABA CODE 803435 OEM NO		AYS CODE 373170 PART NUMBER 72206 AYS S-ABA CODE 802020 OEM NO
KÄLBLE	3718	KAMAZ	4077	KAMAZ	4078
G		H		I	
	AYS CODE 373180 PART NUMBER 72207 AYS S-ABA CODE 802025 OEM NO		AYS CODE 275770 PART NUMBER 79260 AYS S-ABA CODE OEM NO		AYS CODE 275780 PART NUMBER 79261 AYS S-ABA CODE OEM NO
KAMAZ	3202	KAMAZ	2760	KAMAZ	2761
J		K		L	
	AYS CODE 360020 PART NUMBER cs AYS S-ABA CODE 801835 OEM NO		AYS CODE 373600 PART NUMBER 79258 AYS S-ABA CODE 802170 OEM NO		AYS CODE 373610 PART NUMBER 79259 AYS S-ABA CODE 802175 OEM NO

	AYS CODE	CASTING	CONTROL UNIT	APPLICATION	SPLINE TEETH	NO of HOLE	H1	H2	H3	H4	H5	H6	H7	BUSHING (mm)	SPLINE TYPE	CONTROL ARM
A	436560	2756	636	JELTZ	27	1	180							14	BNA 227 D3.5	bent
B	448260	3226	748	JELTZ	27	1	180							14	BNA 227	double bent (short; R=65 mm)
C	577790	4079	777	JELTZ	27	1	180							14	BNA 227 D3.5	double bent (short; R=65 mm)
D	577800	4080	777	JELTZ	27	1	180							14	BNA 227 D3.5	double bent (short; R=65 mm)
E	304850	4085	404	KÄLBLE	26	1	152							16	N42x1.5x9H DIN 5480	bent
F	373170	3717	473	KÄLBLE	37	1	176							16	A36x40 DIN 5481	double bent (medium; R=78 mm)
G	373180	3718	473	KÄLBLE	37	1	176							16	A36x40 DIN 5481	double bent (medium; R=78 mm)
H	275770	4077	175	KAMAZ	10	1	165							14	SAE 1 1/2" 10 C	double bent (short; R=65 mm)
I	275780	4078	175	KAMAZ	10	1	165							14	SAE 1 1/2" 10 C	double bent (short; R=65 mm)
J	360020	3202	260	KAMAZ	10	1	130							12	SAE 1 1/2" 10 C	double bent (long; R=100 mm)
K	373600	2760	373	KAMAZ	10	1	165							14	SAE 1 1/2" 10 C	double bent (short; R=65 mm)
L	373610	2761	373	KAMAZ	10	1	165							14	SAE 1 1/2" 10 C	double bent (short; R=65 mm)

KAMAZ / KAROSA / KYNOS / LEYLAND

KAMAZ	4092	KAMAZ	4093	KAMAZ	2894
A		B		C	
	AYS CODE 438920 PART NUMBER 79727 AYS S-ABA CODE OEM NO		AYS CODE 438930 PART NUMBER 79728 AYS S-ABA CODE OEM NO		AYS CODE 563940 PART NUMBER 79364 AYS S-ABA CODE OEM NO
KAMAZ	2895	KAROSA	4081	KAROSA	4082
D		E		F	
	AYS CODE 563950 PART NUMBER 79365 AYS S-ABA CODE OEM NO		AYS CODE 424810 PART NUMBER 79059 AYS S-ABA CODE OEM NO E4424151042		AYS CODE 424820 PART NUMBER 79060 AYS S-ABA CODE OEM NO E4424151043
KAROSA	2753	KAROSA	2754	KYNOS	4008
G		H		I	
	AYS CODE 446530 PART NUMBER 79057 AYS S-ABA CODE OEM NO 442790570000		AYS CODE 446540 PART NUMBER 79058 AYS S-ABA CODE OEM NO 442790580000		AYS CODE 591081 PART NUMBER 79650 AYS S-ABA CODE 801480 OEM NO
KYNOS	4009	LEYLAND	2894	LEYLAND	2895
J		K		L	
	AYS CODE 591091 PART NUMBER 79651 AYS S-ABA CODE 801485 OEM NO		AYS CODE 245940 PART NUMBER 72560 AYS S-ABA CODE OEM NO NRK3116		AYS CODE 245950 PART NUMBER 72559 AYS S-ABA CODE OEM NO NRK3115

	AYS CODE	CASTING	CONTROL UNIT	APPLICATION	SPLINE TEETH	NO of HOLE	H1	H2	H3	H4	H5	H6	H7	BUSHING (mm)	SPLINE TYPE	CONTROL ARM
A	438920	4092	338	KAMAZ	10	1	165							14	SAE 1 1/2" 10 C	double bent (short; R=65 mm)
B	438930	4093	338	KAMAZ	10	1	165							14	SAE 1 1/2" 10 C	double bent (short; R=65 mm)
C	563940	2894	763	KAMAZ	10	1	150							12,7	SAE 1 1/2" 10 C	double bent (short; R=65 mm)
D	563950	2895	763	KAMAZ	10	1	150							12,7	SAE 1 1/2" 10 C	double bent (short; R=65 mm)
E	424810	4081	624	KAROSA	26	1	240							14	40x1.5 CSN 014950.1	double bent (short; R=65 mm)
F	424820	4082	624	KAROSA	26	1	240							14	40x1.5 CSN 014950.1	double bent (short; R=65 mm)
G	446530	2753	746	KAROSA	26	1	170							14	40x1.5 CSN 014950.1	bent
H	446540	2754	746	KAROSA	26	1	170							14	40x1.5 CSN 014950.1	bent
I	591081	4008	991	KYNOS	10	1	165							14	SAE 1 1/2" 10 C	double bent (short; R=65 mm)
J	591091	4009	991	KYNOS	10	1	165							14	SAE 1 1/2" 10 C	double bent (short; R=65 mm)
K	245940	2894	145	LEYLAND	10	1	152							12,7	SAE 1 1/2" 10 C	bent
L	245950	2895	145	LEYLAND	10	1	152							12,7	SAE 1 1/2" 10 C	bent



LEYLAND

LEYLAND	2755	LEYLAND	2756	LEYLAND	4104
A		B		C	
	AYS CODE 251550 PART NUMBER 70527 AYS S-ABA CODE 800555 OEM NO		AYS CODE 251560 PART NUMBER 70526 AYS S-ABA CODE 800560 OEM NO 843684		AYS CODE 305040 PART NUMBER 70510 AYS S-ABA CODE 802770 OEM NO KB2650
LEYLAND	2760	LEYLAND	2761	LEYLAND	2752
D		E		F	
	AYS CODE 305600 PART NUMBER 70511 AYS S-ABA CODE 802250 OEM NO KB2655		AYS CODE 305610 PART NUMBER 70512 AYS S-ABA CODE 802255 OEM NO ES10907246		AYS CODE 325520 PART NUMBER 70532 AYS S-ABA CODE 803175 OEM NO KB2430
LEYLAND	2755	LEYLAND	2756	LEYLAND	2922
G		H		I	
	AYS CODE 325550 PART NUMBER 70583 AYS S-ABA CODE 800565 OEM NO KB2335		AYS CODE 325560 PART NUMBER 70582 AYS S-ABA CODE 800570 OEM NO KB2390		AYS CODE 333220 PART NUMBER 70624 AYS S-ABA CODE OEM NO XH7062RX
LEYLAND	2771	LEYLAND	2772	LEYLAND	2760
J		K		L	
	AYS CODE 334710 PART NUMBER 70626 AYS S-ABA CODE OEM NO KB2320		AYS CODE 334720 PART NUMBER 70627 AYS S-ABA CODE OEM NO XH70627X		AYS CODE 335600 PART NUMBER 70840 AYS S-ABA CODE 802210 OEM NO AAU3348

	AYS CODE	CASTING	CONTROL UNIT	APPLICATION	SPLINE TEETH	NO of HOLE	H1	H2	H3	H4	H5	H6	H7	BUSHING (mm)	SPLINE TYPE	CONTROL ARM
A	251550	2755	151	LEYLAND	10	1	165							12,7	SAE 1 1/2" 10 C	double bent (short; R=65 mm)
B	251560	2756	151	LEYLAND	10	1	165							12,7	SAE 1 1/2" 10 C	double bent (short; R=65 mm)
C	305040	4104	405	LEYLAND	10	1	114							12,7	SAE 1 1/2" 10 C	bent
D	305600	2760	405	LEYLAND	10	1	178							12,7	SAE 1 1/2" 10 C	bent
E	305610	2761	405	LEYLAND	10	1	178							12,7	SAE 1 1/2" 10 C	bent
F	325520	2752	425	LEYLAND	10	1	203							12,7	SAE 1 1/2" 10 C	bent
G	325550	2755	425	LEYLAND	10	1	165							12,7	SAE 1 1/2" 10 C	bent
H	325560	2756	425	LEYLAND	10	1	165							12,7	SAE 1 1/2" 10 C	bent
I	333220	2922	433	LEYLAND	10	1	178							12,7	SAE 1 1/2" 10 C	bent
J	334710	2771	434	LEYLAND	10	1	165							12,7	SAE 1 1/2" 10 C	bent
K	334720	2772	434	LEYLAND	10	1	165							12,7	SAE 1 1/2" 10 C	bent
L	335600	2760	435	LEYLAND	10	1	165							12,7	SAE 1 1/2" 10 C	bent

LEYLAND	2761	LEYLAND	2752	LEYLAND	2752
A		B		C	
	AYS CODE 335610 PART NUMBER 70841 AYS S-ABA CODE 802215 OEM NO AAU3347		AYS CODE 342520 PART NUMBER 70787 AYS S-ABA CODE 803195 OEM NO CAL1984		AYS CODE 342522 PART NUMBER 72086 AYS S-ABA CODE 803195 OEM NO ACU6280
LEYLAND	4085	LEYLAND	2752	LEYLAND	3226
D		E		F	
	AYS CODE 342850 PART NUMBER 70660 AYS S-ABA CODE 803040 OEM NO		AYS CODE 343520 PART NUMBER 72563 AYS S-ABA CODE 803100 OEM NO NRK3117		AYS CODE 357260 PART NUMBER 72019 AYS S-ABA CODE 800720 OEM NO 0067148S1
LEYLAND	2752	LEYLAND	2752	LEYLAND	2752
G		H		I	
	AYS CODE 360000 PART NUMBER 70530 AYS S-ABA CODE 803090 OEM NO KB2835		AYS CODE 360100 PART NUMBER 70634 AYS S-ABA CODE 803095 OEM NO KB2370		AYS CODE 360200 PART NUMBER 70945 AYS S-ABA CODE 803100 OEM NO KB2315
LEYLAND	2771	LEYLAND	2772	LEYLAND	2771
J		K		L	
	AYS CODE 383710 PART NUMBER 72432 AYS S-ABA CODE OEM NO		AYS CODE 383720 PART NUMBER 72433 AYS S-ABA CODE OEM NO		AYS CODE 385710 PART NUMBER 72439 AYS S-ABA CODE OEM NO KB2345

	AYS CODE	CASTING	CONTROL UNIT	APPLICATION	SPLINE TEETH	NO of HOLE	H1	H2	H3	H4	H5	H6	H7	BUSHING (mm)	SPLINE TYPE	CONTROL ARM
A	335610	2761	435	LEYLAND	10	1	165							12,7	SAE 1 1/2" 10 C	bent
B	342520	2752	442	LEYLAND	10	2	203	151						12.7 (L1: x)	SAE 1 1/2" 10 C	bent
C	342522	2752	442	LEYLAND	10	2	203	171						12.7 (L1: x)	SAE 1 1/2" 10 C	bent
D	342850	4085	442	LEYLAND	10	1	160							12,7	SAE 1 1/2" 10 C	bent
E	343520	2752	443	LEYLAND	10	1	180							12,7	SAE 1 1/2" 10 C	bent
F	357260	3226	357	LEYLAND	10	1	127							12,7	SAE 1 1/2" 10 C	double bent (long; R=100 mm)
G	360000	2752	161	LEYLAND	10	1	178							12,7	SAE 1 1/2" 10 C	double bent (short; R=65 mm)
H	360100	2752	435	LEYLAND	10	1	179							12,7	SAE 1 1/2" 10 C	bent
I	360200	2752	442	LEYLAND	10	1	180							12,7	SAE 1 1/2" 10 C	bent
J	383710	2771	483	LEYLAND	10	1	155							12,7	SAE 1 1/2" 10 C	bent
K	383720	2772	483	LEYLAND	10	1	155							12,7	SAE 1 1/2" 10 C	bent
L	385710	2771	485	LEYLAND	10	1	155							12,7	SAE 1 1/2" 10 C	bent



ABA
Automatic Brake Adjuster / Otomatik Fren Ayar Kolu.
S-ABA
(Self Setting) Automatic Brake Adjuster / Tam Otomatik Fren Ayar Kolu.

* CS > Customer Specific / Özel İmalat

PRODUCT PICTURES ARE TAKEN OF REFERENCE FOR CASTING BODIES. ALSO PLEASE IGNORE CONTROL UNIT & ITS POSITION. ÜRÜN FOTOĞRAFLARI GÖVDELER REFERANS ALINARAK YERLEŞTİRİLMİŞTİR. KİLİT VE KİLİT AÇILARINI DİKKATE ALMAYINIZ.

ALL ORIGINAL NUMBERS, MARKS AND MODELS FROM VEHICLE MANUFACTURERS LISTED IN THIS CATALOGUE ARE FOR COMPARISON PURPOSES ONLY AND MAY NOT BE USED IN INVOICES TO VEHICLE OWNERS OR RESELLERS. / ORJINAL ÜRÜN NUMARALARI MÜŞTERİYİ BİLGİLENDİRME VE ÜRÜNE REFERANS AMAÇLI KULLANILMIŞTIR.

LEYLAND

LEYLAND	2772	LEYLAND	2922	LEYLAND	4033
A		B		C	
	AYS CODE 385720 PART NUMBER 72440 AYS S-ABA CODE OEM NO KB2350		AYS CODE 386220 PART NUMBER 72441 AYS S-ABA CODE OEM NO KB2340		AYS CODE 391330 PART NUMBER 72402 AYS S-ABA CODE OEM NO KB2385
LEYLAND	4033	LEYLAND	4034	LEYLAND	4034
D		E		F	
	AYS CODE 391331 PART NUMBER 72404 AYS S-ABA CODE OEM NO KB2190		AYS CODE 391340 PART NUMBER 72401 AYS S-ABA CODE OEM NO KB2380		AYS CODE 391341 PART NUMBER 72403 AYS S-ABA CODE OEM NO KB2185
LEYLAND	2771	LEYLAND	2772	LEYLAND	2922
G		H		I	
	AYS CODE 494710 PART NUMBER 72420 AYS S-ABA CODE OEM NO ESBCU5534		AYS CODE 494720 PART NUMBER 72421 AYS S-ABA CODE OEM NO ESBCU5535		AYS CODE 495220 PART NUMBER 72422 AYS S-ABA CODE OEM NO ESBCU5536
LEYLAND	2755	LEYLAND	2756	LEYLAND	2765
J		K		L	
	AYS CODE 536550 PART NUMBER 72105 AYS S-ABA CODE 800585 OEM NO KB2495		AYS CODE 536560 PART NUMBER 72106 AYS S-ABA CODE 800590 OEM NO KB2500		AYS CODE 538650 PART NUMBER 70786 AYS S-ABA CODE OEM NO KB2895

	AYS CODE	CASTING	CONTROL UNIT	APPLICATION	SPLINE TEETH	NO of HOLE	H1	H2	H3	H4	H5	H6	H7	BUSHING (mm)	SPLINE TYPE	CONTROL ARM
A	385720	2772	485	LEYLAND	10	1	155							12,7	SAE 1 1/2" 10 C	bent
B	386220	2922	486	LEYLAND	10	1	165							12,7	SAE 1 1/2" 10 C	bent
C	391330	4033	491	LEYLAND	10	1	120							12,7	SAE 1 1/2" 10 C	double bent (long; R=100 mm)
D	391331	4033	491	LEYLAND	10	1	133							12,7	SAE 1 1/2" 10 C	double bent (long; R=100 mm)
E	391340	4034	491	LEYLAND	10	1	120							12,7	SAE 1 1/2" 10 C	double bent (long; R=100 mm)
F	391341	4034	491	LEYLAND	10	1	133							12,7	SAE 1 1/2" 10 C	double bent (long; R=100 mm)
G	494710	2771	594	LEYLAND	10	1	140							12,7	SAE 1 1/2" 10 C	bent
H	494720	2772	594	LEYLAND	10	1	140							12,7	SAE 1 1/2" 10 C	bent
I	495220	2922	595	LEYLAND	10	1	165							12,7	SAE 1 1/2" 10 C	bent
J	536550	2755	936	LEYLAND	10	1	178							12,7	SAE 1 1/2" 10 C	bent
K	536560	2756	936	LEYLAND	10	1	178							12,7	SAE 1 1/2" 10 C	bent
L	538650	2765	938	LEYLAND	10	1	171							12,7	SAE 1 1/2" 10 C	bent

LEYLAND	2766	LEYLAND	4085	LEYLAND	2771
A		B		C	
	AYS CODE 538660 PART NUMBER 70785 AYS S-ABA CODE OEM NO KB2890		AYS CODE 569850 PART NUMBER 72588 AYS S-ABA CODE 802985 OEM NO NRK3550		AYS CODE 571710 PART NUMBER 70943 AYS S-ABA CODE OEM NO KB2475
LEYLAND	2772	LEYLAND	2895	LEYLAND	4033
D		E		F	
	AYS CODE 571720 PART NUMBER 70944 AYS S-ABA CODE OEM NO KB2480		AYS CODE 571950 PART NUMBER 72168 AYS S-ABA CODE OEM NO BCU2077		AYS CODE 574330 PART NUMBER 72192 AYS S-ABA CODE OEM NO ACU7739
LEYLAND	4034	LEYLAND	4104	LEYLAND	4104
G		H		I	
	AYS CODE 574340 PART NUMBER 72191 AYS S-ABA CODE OEM NO ACU7738		AYS CODE 575040 PART NUMBER 72405 AYS S-ABA CODE 802780 OEM NO ACU8346		AYS CODE 575041 PART NUMBER 72406 AYS S-ABA CODE 802775 OEM NO KB2180
LEYLAND	4104	LEYLAND	2752	MAG	2752
J		K		L	
	AYS CODE 575042 PART NUMBER 72407 AYS S-ABA CODE 802895 OEM NO KB2670		AYS CODE 575520 PART NUMBER 72195 AYS S-ABA CODE 802780 OEM NO		AYS CODE 324523 PART NUMBER 72154 AYS S-ABA CODE 803565 OEM NO

	AYS CODE	CASTING	CONTROL UNIT	APPLICATION	SPLINE TEETH	NO of HOLE	H1	H2	H3	H4	H5	H6	H7	BUSHING (mm)	SPLINE TYPE	CONTROL ARM
A	538660	2766	938	LEYLAND	10	1	171							12,7	SAE 1 1/2" 10 C	bent
B	569850	4085	969	LEYLAND	10	1	152							12,7	SAE 1 1/2" 10 C	double bent (long; R=100 mm)
C	571710	2771	971	LEYLAND	10	1	155							12,7	SAE 1 1/2" 10 C	bent
D	571720	2772	971	LEYLAND	10	1	155							12,7	SAE 1 1/2" 10 C	bent
E	571950	2895	971	LEYLAND	10	1	152							12,7	SAE 1 1/2" 10 C	bent
F	574330	4033	774	LEYLAND	10	1	120							12,7	SAE 1 1/2" 10 C	double bent (long; R=100 mm)
G	574340	4034	774	LEYLAND	10	1	120							12,7	SAE 1 1/2" 10 C	double bent (long; R=100 mm)
H	575040	4104	775	LEYLAND	10	1	115							12,7	SAE 1 1/2" 10 C	double bent (short; R=65 mm)
I	575041	4104	775	LEYLAND	10	1	133							12,7	SAE 1 1/2" 10 C	double bent (short; R=65 mm)
J	575042	4104	775	LEYLAND	10	1	140							12,7	SAE 1 1/2" 10 C	double bent (short; R=65 mm)
K	575520	2752	775	LEYLAND	10	1	115							12,7	SAE 1 1/2" 10 C	double bent (short; R=65 mm)
L	324523	2752	424	MAG		4	203	178	152	127				12,7	SQUARE 26.9	bent



MAG / LIAZ

MAG	4092	MAG	4093	LIAZ	4054
A		B		C	
	AYS CODE 560920		AYS CODE 560930		AYS CODE 380540
	PART NUMBER 79101		PART NUMBER 79102		PART NUMBER 72357
	AYS S-ABA CODE		AYS S-ABA CODE		AYS S-ABA CODE
	OEM NO		OEM NO		OEM NO 4W3670
LIAZ	4055	LIAZ	2901	LIAZ	2902
D		E		F	
	AYS CODE 380550		AYS CODE 420010		AYS CODE 420020
	PART NUMBER 72358		PART NUMBER 72867		PART NUMBER 72868
	AYS S-ABA CODE		AYS S-ABA CODE 801150		AYS S-ABA CODE 801155
	OEM NO 4W3675		OEM NO		OEM NO
LIAZ	4079	LIAZ	4080	LIAZ	2901
G		H		I	
	AYS CODE 474790		AYS CODE 474800		AYS CODE 480010
	PART NUMBER 12206		PART NUMBER 12207		PART NUMBER 72566
	AYS S-ABA CODE		AYS S-ABA CODE		AYS S-ABA CODE 801170
	OEM NO		OEM NO		OEM NO
LIAZ	2902	LIAZ	3717	LIAZ	3718
J		K		L	
	AYS CODE 480020		AYS CODE 571170		AYS CODE 571180
	PART NUMBER 72567		PART NUMBER 12363		PART NUMBER 12364
	AYS S-ABA CODE 801175		AYS S-ABA CODE 801925		AYS S-ABA CODE 801930
	OEM NO		OEM NO		OEM NO

	AYS CODE	CASTING	CONTROL UNIT	APPLICATION	SPLINE TEETH	NO of HOLE	H1	H2	H3	H4	H5	H6	H7	BUSHING (mm)	SPLINE TYPE	CONTROL ARM
A	560920	4092	860	MAG	25	1	167							12,7	JIS B 1602	double bent (short; R=65 mm)
B	560930	4093	860	MAG	25	1	167							12,7	JIS B 1602 L=29.4	double bent (medium; R=78 mm)
C	380540	4054	380	LIAZ	26	1	150							14	40x1.5 CSN 014950.1	bent
D	380550	4055	380	LIAZ	26	1	150							14	40x1.5 CSN 014950.1	bent
E	420010	2901	620	LIAZ	26	1	160							14	40x1.5 CSN 014950.1	double bent (short; R=65 mm)
F	420020	2902	620	LIAZ	26	1	160							14	40x1.5 CSN 014950.1	double bent (short; R=65 mm)
G	474790	4079	574	LIAZ	26	1	200							14	40x1.5 CSN 014950.1	double bent (short; R=65 mm)
H	474800	4080	574	LIAZ	26	1	200							14	40x1.5 CSN 014950.1	double bent (short; R=65 mm)
I	480010	2901	580	LIAZ	26	1	200							14	40x1.5 CSN 014950.1	double bent (short; R=65 mm)
J	480020	2902	580	LIAZ	26	1	200							14	40x1.5 CSN 014950.1	double bent (short; R=65 mm)
K	571170	3717	771	LIAZ	19	1	165							14	A38x34 DIN 5482	double bent (short; R=65 mm)
L	571180	3718	771	LIAZ	19	1	165							14	A38x34 DIN 5482	double bent (short; R=65 mm)

MARSHALL / MENARINI / MEIHOKU / MONTENEGRO / MILITARY TRAILER / MERCURY / MULLER / MONTRACON / MOTORAL

A	MARSHALL	2752		2752		C	MENARINI	4085	
			AYS CODE 362521 PART NUMBER 79082 AYS S-ABA CODE 803520 OEM NO A4037350						AYS CODE 565852 PART NUMBER 70903 AYS S-ABA CODE 803035 OEM NO 4W3495
D	MEIHOKU	2760		2761		F	MONTENEGRO	4076	
			AYS CODE 481600 PART NUMBER 79493 AYS S-ABA CODE 802330 OEM NO 4W4000						AYS CODE 438701 PART NUMBER 79112 AYS S-ABA CODE 800070 OEM NO 120015100002
G	MILITARY TRAILER	2752		4104		I	MULLER	4097	
			AYS CODE 518520 PART NUMBER 72143 AYS S-ABA CODE 803120 OEM NO CF3510393						AYS CODE 240970 PART NUMBER 79114 AYS S-ABA CODE 803610 OEM NO
J	MULLER	4097		4086		L	MOTORAL	3068	
			AYS CODE 435900 PART NUMBER 79091 AYS S-ABA CODE 803605 OEM NO						AYS CODE 353680 PART NUMBER 79491 AYS S-ABA CODE 801410 OEM NO





	AYS CODE	CASTING	CONTROL UNIT	APPLICATION	SPLINE TEETH	NO of HOLE	H1	H2	H3	H4	H5	H6	H7	BUSHING (mm)	SPLINE TYPE	CONTROL ARM
A	362521	2752	362	MARSHALL	28	1	165							12,7	SAE 1 7/16" 28 C	double bent (long; R=100 mm)
B	362522	2752	362	MARSHALL	28	1	152							x	SAE 1 7/16" 28 C	double bent (long; R=100 mm)
C	565852	4085	865	MENARINI	10	1	160							12,7	SAE 1 1/2" 10 C	double bent (short; R=65 mm)
D	481600	2760	581	MEIHOKU	14	1	150							12,7	JIS D 2001 40x12x2.5	double bent (medium; R=78 mm)
E	481610	2761	581	MEIHOKU	14	1	150							12,7	JIS D 2001 40x12x2.5	double bent (medium; R=78 mm)
F	438701	4076	738	MONTENEGRO	10	6	250	180	155	140	125	105		14	SAE 1 1/2" 10 C	ays-saddle type
G	518520	2752	918	MILITARY TRAILER	10	1	190							12,7	SAE 1 1/2" 10 C	bent
H	344040	4104	444	MERCURY	28	1	140							12,7	SAE 1 1/2" 28 C	bent
I	240970	4097	240	MULLER	10	5	200	145	126	115	101			14	SAE 1 1/2" 10 C	double bent (long; R=100 mm)
J	435900	4097	635	MULLER	10	5	200	145	126	115	101			14	SAE 1 1/2" 10 C	ays-saddle type
K	326862	4086	426	MONTRACON	10	5	215	181	153	129	105			14	SAE 1 1/2" 10 C	bent
L	353680	3068	453	MOTORAL	19	1	170							14	A38x34 DIN 5482	double bent (long; R=100 mm)



MOTORAL / NISHIUMI / OPTARE / PANAV / PEGASO

MOTORAL	3069	NISHIUMI	2752	NISHIUMI	2752
A		B		C	
	AYS CODE 353690 PART NUMBER 79492 AYS S-ABA CODE 801415 OEM NO		AYS CODE 509520 PART NUMBER 72697 AYS S-ABA CODE 803280 OEM NO		AYS CODE 526520 PART NUMBER 72698 AYS S-ABA CODE 803245 OEM NO 10285
OPTARE	3226	PANAV	4032	PEGASO	3068
D		E		F	
	AYS CODE 508261 PART NUMBER 79177 AYS S-ABA CODE 800900 OEM NO L2220055		AYS CODE 555321 PART NUMBER 72888 AYS S-ABA CODE 803710 OEM NO 12226		AYS CODE 309680 PART NUMBER 72618 AYS S-ABA CODE 801350 OEM NO 917983
PEGASO	2752	PEGASO	4085	PEGASO	2753
G		H		I	
	AYS CODE 310600 PART NUMBER 72408 AYS S-ABA CODE 803320 OEM NO 4W3535		AYS CODE 322850 PART NUMBER 72214 AYS S-ABA CODE 803305 OEM NO 718984		AYS CODE 360530 PART NUMBER 72217 AYS S-ABA CODE OEM NO 914248
PEGASO	2754	PEGASO	3068	PEGASO	3069
J		K		L	
	AYS CODE 360540 PART NUMBER 72218 AYS S-ABA CODE OEM NO 914249		AYS CODE 360680 PART NUMBER 72216 AYS S-ABA CODE 801390 OEM NO 914244		AYS CODE 360690 PART NUMBER 72215 AYS S-ABA CODE 801395 OEM NO 914245

	AYS CODE	CASTING	CONTROL UNIT	APPLICATION	SPLINE TEETH	NO of HOLE	H1	H2	H3	H4	H5	H6	H7	BUSHING (mm)	SPLINE TYPE	CONTROL ARM
A	353690	3069	453	MOTORAL	19	1	170							14	A38x34 DIN 5482	double bent (long; R=100 mm)
B	509520	2752	909	NISHIUMI	19	1	150							12,7	A38x34 DIN 5482	bent
C	526520	2752	926	NISHIUMI	19	1	150							12,7	A38x34 DIN 5482	bent
D	508261	3226	908	OPTARE	28	1	140							12,7	SAE 1 1/2" 28 C	bent
E	555321	4032	855	PANAV	20	5	250	225	200	175	150			14	A40x36 DIN 5482	double bent (short; R=65 mm)
F	309680	3068	709	PEGASO	19	1	140							14	A38x34 DIN 5482	double bent (short; R=65 mm)
G	310600	2752	376	PEGASO	19	1	180							14	A38x34 DIN 5482	double bent (short; R=65 mm)
H	322850	4085	422	PEGASO	19	1	160							14	A38x34 DIN 5482	bent
I	360530	2753	360	PEGASO	19	1	200							14	A38x34 DIN 5482	bent
J	360540	2754	360	PEGASO	19	1	200							14	A38x34 DIN 5482	bent
K	360680	3068	360	PEGASO	19	1	160							14	A38x34 DIN 5482	bent
L	360690	3069	360	PEGASO	19	1	160							14	A38x34 DIN 5482	bent

A	PEGASO	4085		AYS CODE 409850	PART NUMBER 72804	AYS S-ABA CODE 803300	OEM NO KB2915
B	PEGASO	3069		AYS CODE 410002	PART NUMBER 72803	AYS S-ABA CODE 801405	OEM NO 917981
C	PEGASO	4085		AYS CODE 410850	PART NUMBER 72828	AYS S-ABA CODE 803295	OEM NO 917985
D	PEGASO	3068		AYS CODE 420000	PART NUMBER 72802	AYS S-ABA CODE 801400	OEM NO 917980
E	RABA	2753		AYS CODE 264530	PART NUMBER 79402	AYS S-ABA CODE	OEM NO 699434
F	RABA	2754		AYS CODE 264540	PART NUMBER 79403	AYS S-ABA CODE	OEM NO 699433
G	RABA	4085		AYS CODE 264850	PART NUMBER 72928	AYS S-ABA CODE 803345	OEM NO 4W3950
H	RABA	3185		AYS CODE 312850	PART NUMBER 79107	AYS S-ABA CODE 801785	OEM NO
I	RABA	3186		AYS CODE 312860	PART NUMBER 79108	AYS S-ABA CODE 801790	OEM NO
J	RABA	2752		AYS CODE 320400	PART NUMBER 79056	AYS S-ABA CODE 803350	OEM NO 4W3900
K	RABA	3226		AYS CODE 390000	PART NUMBER 79079	AYS S-ABA CODE 800840	OEM NO 4W3905
L	RABA	4085		AYS CODE 402850	PART NUMBER 79121	AYS S-ABA CODE 803340	OEM NO 654172







	AYS CODE	CASTING	CONTROL UNIT	APPLICATION	SPLINE TEETH	NO of HOLE	H1	H2	H3	H4	H5	H6	H7	BUSHING (mm)	SPLINE TYPE	CONTROL ARM
A	409850	4085	709	PEGASO	19	1	160							14	A38x34 DIN 5482	double bent (short; R=65 mm)
B	410002	3069	710	PEGASO	19	1	160							14	A38x34 DIN 5482	double bent (short; R=65 mm)
C	410850	4085	710	PEGASO	19	1	160							14	A38x34 DIN 5482	double bent (short; R=65 mm)
D	420000	3068	710	PEGASO	19	1	160							14	A38x34 DIN 5482	double bent (short; R=65 mm)
E	264530	2753	164	RABA	20	1	155							14	A40x36 DIN 5482	bent
F	264540	2754	164	RABA	20	1	155							14	A40x36 DIN 5482	bent
G	264850	4085	164	RABA	20	2	155	127						14	A40x36 DIN 5482	bent
H	312850	3185	412	RABA	20	1	145							14	A40x36 DIN 5482	bent
I	312860	3186	412	RABA	20	1	145							14	A40x36 DIN 5482	bent
J	320400	2752	410	RABA	20	1	175							14	A40x36 DIN 5482	bent
K	390000	3226	813	RABA	20	1	175							14	A40x36 DIN 5482	bent
L	402850	4085	702	RABA	20	1	145							14	A40x36 DIN 5482	bent



RABA / REYNOLDS / ROR

A		4032 AYS CODE 555320 PART NUMBER 72614 AYS S-ABA CODE 803710 OEM NO
B		4032 AYS CODE 471320 PART NUMBER 79067 AYS S-ABA CODE 803615 OEM NO 209923
C		2897 AYS CODE 314970 PART NUMBER 70884 AYS S-ABA CODE OEM NO
D		2760 AYS CODE 322602 PART NUMBER 72917 AYS S-ABA CODE 802100 OEM NO 21222924
E		2761 AYS CODE 322612 PART NUMBER 72918 AYS S-ABA CODE 802105 OEM NO 21222925
F		4086 AYS CODE 326861 PART NUMBER 72259 AYS S-ABA CODE 803765 OEM NO
G		4076 AYS CODE 361760 PART NUMBER 79160 AYS S-ABA CODE 800070 OEM NO MAS9289
H		4097 AYS CODE 361970 PART NUMBER 79183 AYS S-ABA CODE 800060 OEM NO P17179183
I		3226 AYS CODE 393260 PART NUMBER 79080 AYS S-ABA CODE 800915 OEM NO 77909
J		4086 AYS CODE 398860 PART NUMBER 72359 AYS S-ABA CODE 803635 OEM NO CF351531
K		4086 AYS CODE 399860 PART NUMBER 72260 AYS S-ABA CODE 803650 OEM NO 72095
L		4076 AYS CODE 400010 PART NUMBER 79109 AYS S-ABA CODE 800070 OEM NO

	AYS CODE	CASTING	CONTROL UNIT	APPLICATION	SPLINE TEETH	NO of HOLE	H1	H2	H3	H4	H5	H6	H7	BUSHING (mm)	SPLINE TYPE	CONTROL ARM
A	555320	4032	855	RABA	20	5	250	225	200	175	150			14	A40x36 DIN 5482	double bent (short; R=65 mm)
B	471320	4032	571	REYNOLDS	10	2	203	127						14	SAE 1 1/2" 10 C	double bent (medium; R=78 mm)
C	314970	2897	414	ROR	10	2	254	152						12,7	SAE 1 1/2" 10 C	bent
D	322602	2760	422	ROR	10	1	140							14	SAE 1 1/2" 10 C	bent
E	322612	2761	422	ROR	10	1	140							14	SAE 1 1/2" 10 C	bent
F	326861	4086	426	ROR	37	5	215	181	153	129	105			14 (L1: x)	SAE J 498	bent
G	361760	4076	261	ROR	10	6	250	180	155	140	125	105		14	SAE 1 1/2" 10 C	bent
H	361970	4097	261	ROR	10	3	153	140	127					14	SAE 1 1/2" 10 C	bent
I	393260	3226	493	ROR	28	1	165							14	SAE 1 7/16" 28 C	double bent (long; R=100 mm)
J	398860	4086	298	ROR	10	3	215	142	118					14 (L1: 16)	SAE 1 1/2" 10 C	bent
K	399860	4086	299	ROR	10	5	215	181	153	129	105			14	SAE 1 1/2" 10 C	bent
L	400010	4076	808	ROR	10	6	250	180	155	140	125	105		14	SAE 1 1/2" 10 C	ays-saddle type

ROR	2752	ROR	2755	ROR	2756
A		B		C	
	AYS CODE 400100 PART NUMBER 70576 AYS S-ABA CODE 803165 OEM NO FL932/002		AYS CODE 437550 PART NUMBER 79097 AYS S-ABA CODE 800595 OEM NO TP02003003X		AYS CODE 437560 PART NUMBER 79098 AYS S-ABA CODE 800610 OEM NO TP02003004X
ROR	4086	ROR	4086	ROR	4097
D		E		F	
	AYS CODE 437860 PART NUMBER 79051 AYS S-ABA CODE 803640 OEM NO P17179051		AYS CODE 468860 PART NUMBER 72256 AYS S-ABA CODE 803170 OEM NO KB1065		AYS CODE 508900 PART NUMBER 72788 AYS S-ABA CODE 800060 OEM NO Y10538610
ROR	4086	ROR/SAB	2752	ROR/SAB	2752
G		H		I	
	AYS CODE 534860 PART NUMBER 72255 AYS S-ABA CODE 803170 OEM NO CF3505492		AYS CODE 314520 PART NUMBER 70882 AYS S-ABA CODE 803170 OEM NO		AYS CODE 314521 PART NUMBER 70883 AYS S-ABA CODE 803215 OEM NO
ROR/SAB	2752	SAB	2897	SAB	2752
J		K		L	
	AYS CODE 314522 PART NUMBER 70886 AYS S-ABA CODE 803125 OEM NO		AYS CODE 338971 PART NUMBER 70865 AYS S-ABA CODE OEM NO BBU9770		AYS CODE 519520 PART NUMBER 70887 AYS S-ABA CODE 803170 OEM NO

	AYS CODE	CASTING	CONTROL UNIT	APPLICATION	SPLINE TEETH	NO of HOLE	H1	H2	H3	H4	H5	H6	H7	BUSHING (mm)	SPLINE TYPE	CONTROL ARM
A	400100	2752	424	ROR	10	4	203	178	152	127				12,7	SAE 1 1/2" 10 C	bent
B	437550	2755	737	ROR	10	3	180	150	125					14	SAE 1 1/2" 10 C	double bent (short; R=65 mm)
C	437560	2756	737	ROR	10	3	180	150	125					14	SAE 1 1/2" 10 C	double bent (short; R=65 mm)
D	437860	4086	737	ROR	10	5	215	181	153	129	105			14	SAE 1 1/2" 10 C	double bent (short; R=65 mm)
E	468860	4086	568	ROR	10	5	215	181	153	129	105			12,7	SAE 1 1/2" 10 C	bent
F	508900	4097	808	ROR	10	5	205	153	140	127	115			14	SAE 1 1/2" 10 C	ays-saddle type
G	534860	4086	934	ROR	10	5	215	181	153	129	105			12,7	SAE 1 1/2" 10 C	bent
H	314520	2752	414	ROR/SAB	10	4	203	178	152	127				12,7	SAE 1 1/2" 10 C	bent
I	314521	2752	414	ROR/SAB	10	0									SAE 1 1/2" 10 C	bent
J	314522	2752	414	ROR/SAB	10	2	190	140						12,7	SAE 1 1/2" 10 C	bent
K	338971	2897	438	SAB	10	2	210	175						16	SAE 1 1/2" 10 C	bent
L	519520	2752	919	SAB	10	4	203	178	152	127				12,7	SAE 1 1/2" 10 C	bent



SAB / ROR / VH / RUTHMANN / SCAMMEL / SAURER / SEDDON ATKINSON / SICCA / SMB

A	SAB	2897		AYS CODE 562970 PART NUMBER 70866 AYS S-ABA CODE OEM NO
B	ROR/VH	4076		AYS CODE 508701 PART NUMBER 79619 AYS S-ABA CODE 803670 OEM NO 105031111
C	RUTHMANN	3226		AYS CODE 425260 PART NUMBER 72862 AYS S-ABA CODE 800805 OEM NO
D	SCAMMEL	2752		AYS CODE 527520 PART NUMBER 70573 AYS S-ABA CODE 802905 OEM NO
E	SAURER	2752		AYS CODE 430000 PART NUMBER 70762 AYS S-ABA CODE 803315 OEM NO 4W2770
F	SAURER	2752		AYS CODE 430100 PART NUMBER 70764 AYS S-ABA CODE 803315 OEM NO 9543311002
G	SEDDON ATKINSON	3226		AYS CODE 357261 PART NUMBER 72114 AYS S-ABA CODE 800735 OEM NO 3291747R
H	SEDDON ATKINSON	3226		AYS CODE 362260 PART NUMBER 72198 AYS S-ABA CODE 800720 OEM NO
I	SEDDON ATKINSON	4085		AYS CODE 376850 PART NUMBER 72356 AYS S-ABA CODE 803285 OEM NO 914266
J	SICCA	2752		AYS CODE 497520 PART NUMBER 72419 AYS S-ABA CODE 802740 OEM NO S5004035
K	SICCA	2752		AYS CODE 560520 PART NUMBER 70919 AYS S-ABA CODE 802745 OEM NO S5001048
L	SMB	4086		AYS CODE 435800 PART NUMBER 79004 AYS S-ABA CODE 800075 OEM NO MR23565701

	AYS CODE	CASTING	CONTROL UNIT	APPLICATION	SPLINE TEETH	NO of HOLE	H1	H2	H3	H4	H5	H6	H7	BUSHING (mm)	SPLINE TYPE	CONTROL ARM
A	562970	2897	962	SAB	10	2	210	175						16	SAE 1 1/2" 10 C	bent
B	508701	4076	808	ROR/VH	10	7	238	203	178	152	140	127	114	14 (L1: x)	SAE 1 1/2" 10 C	ays-saddle type
C	425260	3226	725	RUTHMANN	10	3	178	152	127					14	SAE 1 1/2" 10 C	double bent (long; R=100 mm)
D	527520	2752	927	SCAMMEL	10	1	140							12,7	SAE 1 1/2" 10 C	bent
E	430000	2752	877	SAURER	19	2	180	135						14 (L1: x)	A38x34 DIN 5482	double bent (short; R=65 mm)
F	430100	2752	871	SAURER	19	2	180	135						14	A38x34 DIN 5482	double bent (short; R=65 mm)
G	357261	3226	357	SEDDON ATKINSON	10	1	140							12,7	SAE 1 1/2" 10 C	double bent (long; R=100 mm)
H	362260	3226	362	SEDDON ATKINSON	10	1	127							12,7	SAE 1 1/2" 10 C	double bent (long; R=100 mm)
I	376850	4085	376	SEDDON ATKINSON	19	1	150							14	A38x34 DIN 5482	double bent (short; R=65 mm)
J	497520	2752	597	SICCA	8	1	180							12,7	32 UNI 222	double bent (short; R=65 mm)
K	560520	2752	860	SICCA	8	1	180							12,7	32 UNI 222	double bent (short; R=65 mm)
L	435800	4086	635	SMB	10	4	215	153	129	105				14 (L1: 16)	SAE 1 1/2" 10 C	ays-saddle type











STAR / STEER AXLE / STEFEN / STEYR / TATRA

STAR	4104	STEER AXLE	2760	STEER AXLE	2761
A		B		C	
	AYS CODE 419040 PART NUMBER 72896 AYS S-ABA CODE 803250 OEM NO 12242		AYS CODE 322600 PART NUMBER 12112 AYS S-ABA CODE 802480 OEM NO		AYS CODE 322610 PART NUMBER 12113 AYS S-ABA CODE 802485 OEM NO
STEFEN	2760	STEFEN	2761	STEYR	4104
D		E		F	
	AYS CODE 437600 PART NUMBER 79028 AYS S-ABA CODE 802310 OEM NO P17179028		AYS CODE 437610 PART NUMBER 79029 AYS S-ABA CODE 802315 OEM NO P17179029		AYS CODE 369040 PART NUMBER 72643 AYS S-ABA CODE 802900 OEM NO F4348/F
STEYR	2760	STEYR	2761	TATRA	2760
G		H		I	
	AYS CODE 508600 PART NUMBER 72431 AYS S-ABA CODE 802450 OEM NO 4W3635		AYS CODE 508610 PART NUMBER 72430 AYS S-ABA CODE 802455 OEM NO 4W3640		AYS CODE 310601 PART NUMBER 79510 AYS S-ABA CODE 802410 OEM NO
TATRA	2761	TATRA	2753	TATRA	2754
J		K		L	
	AYS CODE 310610 PART NUMBER 79511 AYS S-ABA CODE 802415 OEM NO		AYS CODE 378530 PART NUMBER 72760 AYS S-ABA CODE OEM NO 4W3585		AYS CODE 378540 PART NUMBER 72759 AYS S-ABA CODE OEM NO 4W3590

	AYS CODE	CASTING	CONTROL UNIT	APPLICATION	SPLINE TEETH	NO of HOLE	H1	H2	H3	H4	H5	H6	H7	BUSHING (mm)	SPLINE TYPE	CONTROL ARM
A	419040	4104	619	STAR	18	1	102							14	N30x1.5x9H DIN 5480	double bent (short; R=65 mm)
B	322600	2760	422	STEER AXLE	37	3	203	179	151					14	SAE J 498	bent
C	322610	2761	422	STEER AXLE	37	3	203	179	151					14	SAE J 498	bent
D	437600	2760	737	STEFEN	10	3	203	179	151					14	SAE 1 1/2" 10 C	double bent (short; R=65 mm)
E	437610	2761	737	STEFEN	10	3	203	179	151					14	SAE 1 1/2" 10 C	double bent (short; R=65 mm)
F	369040	4104	469	STEYR	10	1	140							12,7	SAE 1 1/2" 10 C	double bent (medium; R=78 mm)
G	508600	2760	908	STEYR	28	1	152							12,7	SAE 1 1/2" 28 C	bent
H	508610	2761	908	STEYR	28	1	152							12,7	SAE 1 1/2" 28 C	bent
I	310601	2760	310	TATRA	26	1	175							14	40x1.5 CSN 014950.1	bent
J	310610	2761	310	TATRA	26	1	175							14	40x1.5 CSN 014950.1	bent
K	378530	2753	378	TATRA	36	1	140							14	A30x34 DIN 5481	double bent (short; R=65 mm)
L	378540	2754	378	TATRA	36	1	140							14	A30x34 DIN 5481	double bent (short; R=65 mm)



TATRA / TEMSA / TMM / TRAILER / TRAILOR

TATRA	3658	TATRA	3659	TATRA	4042
A		B		C	
	AYS CODE 422580 PART NUMBER 72742 AYS S-ABA CODE OEM NO		AYS CODE 422590 PART NUMBER 72743 AYS S-ABA CODE OEM NO		AYS CODE 434420 PART NUMBER 79499 AYS S-ABA CODE 801610 OEM NO
TATRA	4043	TEMSA	2901	TEMSA	2902
D		E		F	
	AYS CODE 434430 PART NUMBER 79500 AYS S-ABA CODE 801615 OEM NO		AYS CODE 270100 PART NUMBER 72583 AYS S-ABA CODE 801080 OEM NO TC807634		AYS CODE 270200 PART NUMBER 72584 AYS S-ABA CODE 801085 OEM NO TC807635
TEMSA	3226	TMM	2752	TRAILER	2760
G		H		I	
	AYS CODE 270300 PART NUMBER 72585 AYS S-ABA CODE 800860 OEM NO		AYS CODE 324521 PART NUMBER 12307 AYS S-ABA CODE 803105 OEM NO		AYS CODE 271600 PART NUMBER cs AYS S-ABA CODE OEM NO
TRAILER	2761	TRAILOR	4086 (4032)	TRAILOR	4086
J		K		L	
	AYS CODE 271610 PART NUMBER cs AYS S-ABA CODE OEM NO		AYS CODE 432862 PART NUMBER 72254 AYS S-ABA CODE 800080 OEM NO		AYS CODE 435803 PART NUMBER 79023 AYS S-ABA CODE 800080 OEM NO T0017649Z

	AYS CODE	CASTING	CONTROL UNIT	APPLICATION	SPLINE TEETH	NO of HOLE	H1	H2	H3	H4	H5	H6	H7	BUSHING (mm)	SPLINE TYPE	CONTROL ARM
A	422580	3658	622	TATRA	36	1	275							16	A30x34 DIN 5481	double bent (short; R=65 mm)
B	422590	3659	622	TATRA	36	1	275							16	A30x34 DIN 5481	double bent (short; R=65 mm)
C	434420	4042	634	TATRA	26	1	175							14	40x1.5 CSN 014950.1	bent
D	434430	4043	634	TATRA	26	1	175							14	40x1.5 CSN 014950.1	bent
E	270100	2901	508	TEMSA	25	1	145							14	JIS B 1602	double bent (medium; R=78 mm)
F	270200	2902	508	TEMSA	25	1	145							14	JIS B 1602	double bent (medium; R=78 mm)
G	270300	3226	509	TEMSA	25	1	135							14	JIS B 1602	double bent (medium; R=78 mm)
H	324521	2752	424	TMM	10	2	180	150						14	SAE 1 1/2" 10 C	bent
I	271600	2760	171	TRAILER	10	1	160							14	SAE 1 1/2" 10 C	ays-saddle type
J	271610	2761	171	TRAILER	10	1	160							14	SAE 1 1/2" 10 C	ays-saddle type
K	432862	4086 (4032)	632	TRAILOR	10	4	210	180	150	125				14	SAE 1 1/2" 10 C	bent
L	435803	4086	635	TRAILOR	10	4	210	180	150	125				14	SAE 1 1/2" 10 C	ays-saddle type

YORK	2755	YORK	2756	ZF	3863
A		B		C	
	AYS CODE 322550 PART NUMBER 79065 AYS S-ABA CODE 800535 OEM NO		AYS CODE 322560 PART NUMBER 79066 AYS S-ABA CODE 800540 OEM NO		AYS CODE 210800 PART NUMBER 72203 AYS S-ABA CODE OEM NO B510643
ZF	3863	ZF	3864	ZF	3864
D		E		F	
	AYS CODE 210804 PART NUMBER 79429 AYS S-ABA CODE OEM NO ESXBU1027		AYS CODE 210900 PART NUMBER 72204 AYS S-ABA CODE OEM NO B510642		AYS CODE 210902 PART NUMBER 79430 AYS S-ABA CODE OEM NO ESXBU1028
ZF	3878	ZF	3879	ZF	3900
G		H		I	
	AYS CODE 380000 PART NUMBER 72688 AYS S-ABA CODE 800465 OEM NO KB2785		AYS CODE 380100 PART NUMBER 72689 AYS S-ABA CODE 800470 OEM NO KB2790		AYS CODE 380300 PART NUMBER 72872 AYS S-ABA CODE 802570 OEM NO 0501314043
ZF	3068	ZF	4040	ZF	4085
J		K		L	
	AYS CODE 380400 PART NUMBER 72930 AYS S-ABA CODE 801380 OEM NO 4W3650		AYS CODE 428400 PART NUMBER 72929 AYS S-ABA CODE OEM NO 4W3645		AYS CODE 472850 PART NUMBER 72641 AYS S-ABA CODE 803290 OEM NO 4W3295

	AYS CODE	CASTING	CONTROL UNIT	APPLICATION	SPLINE TEETH	NO of HOLE	H1	H2	H3	H4	H5	H6	H7	BUSHING (mm)	SPLINE TYPE	CONTROL ARM
A	322550	2755	422	YORK	10	1	140							14	SAE 1 1/2" 10 C	bent
B	322560	2756	422	YORK	10	1	140							14	SAE 1 1/2" 10 C	bent
C	210800	3863	778	ZF	19	1	145							14	A38x34 DIN 5482	double bent (short; R=65 mm)
D	210804	3863	778	ZF	19	1	145							14	A38x34 DIN 5482	double bent (short; R=65 mm)
E	210900	3864	778	ZF	19	1	145							14	A38x34 DIN 5482	double bent (short; R=65 mm)
F	210902	3864	778	ZF	19	1	145							14	A38x34 DIN 5482	double bent (short; R=65 mm)
G	380000	3878	475	ZF	19	1	145							14	A38x34 DIN 5482	double bent (short; R=65 mm)
H	380100	3879	475	ZF	19	1	145							14	A38x34 DIN 5482	double bent (short; R=65 mm)
I	380300	3900	474	ZF	19	1	145							14	A38x34 DIN 5482	double bent (short; R=65 mm)
J	380400	3068	373	ZF	19	1	152							14	A38x34 DIN 5482	double bent (short; R=65 mm)
K	428400	4040	628	ZF	19	1	152							14	A38x34 DIN 5482	double bent (short; R=65 mm)
L	472850	4085	572	ZF	19	1	152							14	A38x34 DIN 5482	double bent (short; R=65 mm)













ZF / ZF AXLES / AILSA

ZF A 	4085 AYS CODE 474851 PART NUMBER 72385 AYS S-ABA CODE 803275 OEM NO 501206318	ZF B 	4042 AYS CODE 478420 PART NUMBER 79637 AYS S-ABA CODE 801600 OEM NO 0003520840	ZF C 	4043 AYS CODE 478430 PART NUMBER 79638 AYS S-ABA CODE 801605 OEM NO 0003520940
ZF D 	4016 AYS CODE 480160 PART NUMBER 72931 AYS S-ABA CODE OEM NO 082460820	ZF E 	4017 AYS CODE 480170 PART NUMBER 72932 AYS S-ABA CODE OEM NO 0501314350	ZF F 	3892 AYS CODE 484921 PART NUMBER 72855 AYS S-ABA CODE 800510 OEM NO 4W3065
ZF G 	3893 AYS CODE 484931 PART NUMBER 72854 AYS S-ABA CODE 800505 OEM NO 4W2935	ZF H 	2752(4085) AYS CODE 578520 PART NUMBER 72326 AYS S-ABA CODE 803290 OEM NO 4W2860	ZF AXLES I 	2752 AYS CODE 210400 PART NUMBER cs AYS S-ABA CODE 802955 OEM NO
ZF AXLES J 	2752 AYS CODE 210500 PART NUMBER cs AYS S-ABA CODE 802955 OEM NO	AILSA K 	2985 AYS CODE 261700 PART NUMBER 70832 AYS S-ABA CODE 802600 OEM NO KB2450	AILSA L 	2755 AYS CODE 553550 PART NUMBER 70572 AYS S-ABA CODE 800515 OEM NO 6970/F

	AYS CODE	CASTING	CONTROL UNIT	APPLICATION	SPLINE TEETH	NO of HOLE	H1	H2	H3	H4	H5	H6	H7	BUSHING (mm)	SPLINE TYPE	CONTROL ARM
A	474851	4085	574	ZF	19	1	145							14	A38x34 DIN 5482	double bent (short; R=65 mm)
B	478420	4042	778	ZF	19	1	145							14	A38x34 DIN 5482	double bent (short; R=65 mm)
C	478430	4043	778	ZF	19	1	145							14	A38x34 DIN 5482	double bent (short; R=65 mm)
D	480160	4016	680	ZF	19	1	145							14	A38x34 DIN 5482	double bent (short; R=65 mm)
E	480170	4017	680	ZF	19	1	145							14	A38x34 DIN 5482	double bent (short; R=65 mm)
F	484921	3892	684	ZF	19	1	145							14	A38x34 DIN 5482	double bent (short; R=65 mm)
G	484931	3893	684	ZF	19	1	145							14	A38x34 DIN 5482	double bent (short; R=65 mm)
H	578520	2752(4085)	778	ZF	19	1	152							14	A38x34 DIN 5482	double bent (short; R=65 mm)
I	210400	2752	778	ZF AXLES	10	1	150							14	SAE 1 1/2" 10 C	double bent (short; R=65 mm)
J	210500	2752	900	ZF AXLES	10	1	150							14	SAE 1 1/2" 10 C	double bent (short; R=65 mm)
K	261700	2985	451	AILSA	10	1	147							12,7	SAE 1 1/2" 10 C	double bent (long; R=100 mm)
L	553550	2755	953	AILSA	10	1	140							12,7	SAE 1 1/2" 10 C	bent

AILSA / AJONA / ALBION / BEDFORD / BERGISCHE STADT INDUSTRIE / BREDAMENARINIBUS / COBRA / COMAUTO / DAEWOO

A	AILSA	2756		2756		AJONA	2752	C	ALBION	3522	
			AYS CODE 553560 PART NUMBER 70571 AYS S-ABA CODE 800520 OEM NO 6969/F								AYS CODE 424220 PART NUMBER 79546 AYS S-ABA CODE OEM NO
D	ALBION	3523		2752		BEDFORD	2752	F	BERGISCHE STADT INDUSTRIE	2752	
			AYS CODE 424230 PART NUMBER 79547 AYS S-ABA CODE OEM NO								AYS CODE 437520 PART NUMBER 70752 AYS S-ABA CODE 803110 OEM NO
G	BREDAMENARINIBUS	3226		2752		COBRA	2752	I	COMAUTO	2752	
			AYS CODE 374261 PART NUMBER 72182 AYS S-ABA CODE 800760 OEM NO S5005111								AYS CODE 250520 PART NUMBER 79444 AYS S-ABA CODE 803180 OEM NO
J	DAEWOO	2901		2902		DAEWOO	2902	L	DAEWOO	4085	
			AYS CODE 423010 PART NUMBER 72856 AYS S-ABA CODE 801100 OEM NO								AYS CODE 584850 PART NUMBER 72858 AYS S-ABA CODE 800255 OEM NO 4W3605

	AYS CODE	CASTING	CONTROL UNIT	APPLICATION	SPLINE TEETH	NO of HOLE	H1	H2	H3	H4	H5	H6	H7	BUSHING (mm)	SPLINE TYPE	CONTROL ARM
A	553560	2756	953	AILSA	10	1	140							12,7	SAE 1 1/2" 10 C	bent
B	398520	2752	298	AJONA	10	1	150							14	SAE 1 1/2" 10 C	bent
C	424220	3522	724	ALBION	28	1	130							14	SAE 1 1/2" 28 C	double bent (short; R=65 mm)
D	424230	3523	724	ALBION	28	1	130							14	SAE 1 1/2" 28 C	double bent (short; R=65 mm)
E	361520	2752	361	BEDFORD	10	1	140							12,7	SAE 1 1/2" 10 C	double bent (medium; R=78 mm)
F	437520	2752	637	BERGISCHE STADT INDUSTRIE	10	1	180							14	SAE 1 1/2" 10 C	double bent (short; R=65 mm)
G	374261	3226	474	BREDAMENARINIBUS	10	1	140							14	SAE 1 1/2" 10 C	double bent (short; R=65 mm)
H	267520	2752	167	COBRA	10	2	152	115						14 (L2x:14,5)	SAE 1 1/2" 10 C	saddle type
I	250520	2752	250	COMAUTO	10	1	203							14	SAE 1 1/2" 10 C	double bent (short; R=65 mm)
J	423010	2901	723	DAEWOO	25	1	150							16	JIS B 1602	double bent (short; R=65 mm)
K	423020	2902	723	DAEWOO	25	1	150							16	JIS B 1602	double bent (short; R=65 mm)
L	584850	4085	784	DAEWOO	25	1	150							16	JIS B 1602	double bent (short; R=65 mm)



ABA
Automatic Brake Adjuster / Otomatik Fren Ayar Kolu.
S-ABA
(Self Setting) Automatic Brake Adjuster / Tam Otomatik Fren Ayar Kolu.

* CS > Customer Specific / Özel İmalat

PRODUCT PICTURES ARE TAKEN OF REFERENCE FOR CASTING BODIES. ALSO PLEASE IGNORE CONTROL UNIT & ITS POSITION. ÜRÜN FOTOĞRAFLARI GÖVDELER REFERANS ALINARAK YERLEŞTİRİLMİŞTİR. KİLİT VE KİLİT AÇILARINI DİKKATE ALMAYINIZ.





ALL ORIGINAL NUMBERS, MARKS AND MODELS FROM VEHICLE MANUFACTURERS LISTED IN THIS CATALOGUE ARE FOR COMPARISON PURPOSES ONLY AND MAY NOT BE USED IN INVOICES TO VEHICLE OWNERS OR RESELLERS. / ORJINAL ÜRÜN NUMARALARI MÜŞTERİYİ BİLGİLENDİRME VE ÜRÜNE REFERANS AMAÇLI KULLANILMIŞTIR.

FRENELSA / GB RAILWAY / ISUZU / IVECO / IVECO CITY CLASS / IVECO PEGASO / JIMECAL / JP SPAIN

FRENELSA	2753	FRENELSA	2754	GB RAILWAY	2897
A		B		C	
	AYS CODE 326530 PART NUMBER 12351 AYS S-ABA CODE OEM NO 412004		AYS CODE 326540 PART NUMBER 12350 AYS S-ABA CODE OEM NO 412003		AYS CODE 338972 PART NUMBER 70980 AYS S-ABA CODE OEM NO
ISUZU	2752	IVECO	2752	IVECO CITY CLASS	2894
D		E		F	
	AYS CODE 273520 PART NUMBER cs AYS S-ABA CODE 803360 OEM NO		AYS CODE 310600 PART NUMBER 72408 AYS S-ABA CODE 803320 OEM NO 4W3535		AYS CODE 544940 PART NUMBER 79122 AYS S-ABA CODE OEM NO
IVECO CITY CLASS	2895	IVECO PEGASO	3068	IVECO PEGASO	3069
G		H		I	
	AYS CODE 548950 PART NUMBER 79123 AYS S-ABA CODE OEM NO		AYS CODE 497680 PART NUMBER 72446 AYS S-ABA CODE 801420 OEM NO 4W3355		AYS CODE 497690 PART NUMBER 72447 AYS S-ABA CODE 801425 OEM NO 4W3360
JIMECAL	4085	JP SPAIN	3068	JP SPAIN	3069
J		K		L	
	AYS CODE 514850 PART NUMBER 72817 AYS S-ABA CODE 802975 OEM NO 4W3530		AYS CODE 474680 PART NUMBER 79455 AYS S-ABA CODE 801240 OEM NO 4W3565		AYS CODE 474690 PART NUMBER 79456 AYS S-ABA CODE 801245 OEM NO 4W3570

	AYS CODE	CASTING	CONTROL UNIT	APPLICATION	SPLINE TEETH	NO of HOLE	H1	H2	H3	H4	H5	H6	H7	BUSHING (mm)	SPLINE TYPE	CONTROL ARM
A	326530	2753	426	FRENELSA	10	2	190	155						14	SAE 1 1/2" 10 C	bent
B	326540	2754	426	FRENELSA	10	2	190	155						14	SAE 1 1/2" 10 C	bent
C	338972	2897	438	GB RAILWAY	10	1	178							16	SAE 1 1/2" 10 C	bent
D	273520	2752	573	ISUZU	24	1	130							12,7	SAE 1 1/4" 24 C	isuzu
E	310600	2752	376	IVECO	19	1	180							14	A38x34 DIN 5482	double bent (short; R=65 mm)
F	544940	2894	244	IVECO CITY CLASS	27	1	180							14	BNA 227	double bent (short; R=65 mm)
G	548950	2895	248	IVECO CITY CLASS	27	1	180							14	BNA 227	double bent (short; R=65 mm)
H	497680	3068	597	IVECO PEGASO	19	1	185							14	A38x34 DIN 5482	double bent (short; R=65 mm)
I	497690	3069	597	IVECO PEGASO	19	1	180							14	A38x34 DIN 5482	double bent (short; R=65 mm)
J	514850	4085	814	JIMECAL	10	2	150	125						14	SAE 1 1/2" 10 C	double bent (short; R=65 mm)
K	474680	3068	574	JP SPAIN	10	1	160							14	SAE 1 1/2" 10 C	double bent (short; R=65 mm)
L	474690	3069	574	JP SPAIN	10	1	160							14	SAE 1 1/2" 10 C	double bent (short; R=65 mm)

JP SPAIN / JPB / MAGIRUS / NISSAN / PERROD / PPS / RELIANCE MERCURY / SAMRO

A	JP SPAIN	4085		4085		C	MAGIRUS	2752			
		AYS CODE 581850			AYS CODE 429850			AYS CODE 457520			
		PART NUMBER 79454			PART NUMBER 79658			PART NUMBER CS			
		AYS S-ABA CODE 803365			AYS S-ABA CODE 803030			AYS S-ABA CODE 803355			
		OEM NO 4W3560			OEM NO			OEM NO			
D	NISSAN	4085		E	NISSAN	4092		F	NISSAN	4093	
		AYS CODE 560850			AYS CODE 560920				AYS CODE 560930		
		PART NUMBER 79192			PART NUMBER 79101				PART NUMBER 79102		
		AYS S-ABA CODE 803380			AYS S-ABA CODE				AYS S-ABA CODE		
		OEM NO			OEM NO				OEM NO		
G	PERROD	3202		H	PPS	3068		I	PPS	3069	
		AYS CODE 594020			AYS CODE 290600				AYS CODE 290601		
		PART NUMBER 72157			PART NUMBER 79345				PART NUMBER 79344		
		AYS S-ABA CODE 803795			AYS S-ABA CODE 801430				AYS S-ABA CODE 801435		
		OEM NO			OEM NO				OEM NO		
J	RELIANCE MERCURY	4085		K	SAMRO	4086 (4032)					
		AYS CODE 344852			AYS CODE 432862						
		PART NUMBER 79268			PART NUMBER 72254						
		AYS S-ABA CODE 803525			AYS S-ABA CODE 800080						
		OEM NO 819137			OEM NO						

	AYS CODE	CASTING	CONTROL UNIT	APPLICATION	SPLINE TEETH	NO of HOLE	H1	H2	H3	H4	H5	H6	H7	BUSHING (mm)	SPLINE TYPE	CONTROL ARM
A	581850	4085	781	JP SPAIN	24	1	160							14	SAE 1 1/4" 24 C	double bent (short; R=65 mm)
B	429850	4085	329	JPB	10	2	155	127						12,7	SAE 1 1/2" 10 C	double bent (medium; R=78 mm)
C	457520	2752	557	MAGIRUS	24	2	105	130						12,7	SAE 1 1/4" 24 C	double bent (short; R=65 mm)
D	560850	4085	860	NISSAN	25	1	152							12,7	JIS B 1602	double bent (short; R=65 mm)
E	560920	4092	860	NISSAN	25	1	167							12,7	JIS B 1602	double bent (short; R=65 mm)
F	560930	4093	860	NISSAN	25	1	167							12,7	JIS B 1602 L=29.4	double bent (medium; R=78 mm)
G	594020	3202	994	PERROD	19	1	130							14	A38x34 DIN 5482	double bent (short; R=65 mm)
H	290600	3068	190	PPS	26	1	140							14	40x1.5 CSN 014950.1	ays-saddle type
I	290601	3069	190	PPS	26	1	140							14	40x1.5 CSN 014950.1	ays-saddle type
J	344852	4085	444	RELIANCE MERCURY	28	1	165							12,7	SAE 1 1/2" 28 C	bent
K	432862	4086 (4032)	632	SAMRO	10	4	210	180	150	125				14	SAE 1 1/2" 10 C	bent
L																



THE TECHNICAL LIST OF BRAKE ADJUSTERS FOR OTHER BRANDED COMMERCIAL VEHICLES

AYS CODE	CASTING	CONTROL UNIT	APPLICATION	SPLINE TEETH	NO of HOLE	H1	H2	H3	H4	H5	H6	H7	BUSHING (mm)	SPLINE TYPE	CONTROL ARM
202170	3717	202		27	1	175							14	BNA 227 D3.5	double bent (short; R=65 mm)
202180	3718	202		27	1	175							14	BNA 227 D3.5	double bent (short; R=65 mm)
206010	2901	206		25	1	150							16	JIS B 1602	bent
206020	2902	206		25	1	150							16	JIS B 1602	bent
206850	4085	206		25	1	150							16	JIS B 1602	bent
207050	4105	207		25	1	150							16	JIS B 1602	bent
207060	4106	207		25	1	150							16	JIS B 1602	bent
210016	4076	635		10	7	238	203	178	152	140	127	114	14	SAE 1 1/2" 10 C	ays-saddle type
246600	3068	246		26	1	170							14	40x1.5 CSN 014950.1	ays-saddle type
246601	3069	246		26	1	170							14	40x1.5 CSN 014950.1	ays-saddle type
246610	3068	246		26	1	150							14	40x1.5 CSN 014950.1	ays-saddle type
246611	3069	246		26	1	150							14	40x1.5 CSN 014950.1	ays-saddle type
248940	2894	148		10	2	178	153						14	SAE 1 1/2" 10 C	double bent (short; R=65 mm)
248950	2895	148		10	2	178	153						14	SAE 1 1/2" 10 C	double bent (short; R=65 mm)
250601	2760	250		10	2	178	153						14	SAE 1 1/2" 10 C	double bent (short; R=65 mm)
250610	2761	250		10	2	178	153						14	SAE 1 1/2" 10 C	double bent (short; R=65 mm)
254780	3078	854		10	1	115							14	SAE 1 1/2" 10 C	double bent (short; R=65 mm)
255520	2752	855		20	1	130							14	A40x36 DIN 5482	double bent (short; R=65 mm)
261800	2987	451		10	1	165							14	SAE 1 1/2" 10 C	double bent (long; R=100 mm)
264010	2901	164		19	1	150							12,7	A38x34 DIN 5482	bent
264020	2902	164		19	1	150							12,7	A38x34 DIN 5482	bent
269850	4085	169		28	2	152	127						12,7	SAE 1 1/2" 28 C	bent
272520	2752	172		25	3	190	160	130					14	JIS B 1602	double bent (medium; R=78 mm)
276520	2752	476		20	1	145							14	A40x36 DIN 5482	double bent (medium; R=78 mm)
296010	2901	196		25	1	150							16	JIS B 1602	bent
296020	2902	196		25	1	150							16	JIS B 1602	bent
306010	2901	406		12	1	150							12,7	JIS D 2001 (35x12)	bent
306020	2902	406		12	1	150							12,7	JIS D 2001 (35x12)	bent
312500	4050	412		10	1	130							12	SAE 1 1/2" 10 C	bent
312510	4051	412		10	1	130							12	SAE 1 1/2" 10 C	bent
313260	3226	313		14	1	135							12	JIS D 2001 (40x14)	bent
313630	3863	513		10	3	178	152	127					14	SAE 1 1/2" 10 C	straight
316520	2752	316		25	2	155	129						12,7	JIS B 1602 L=29.4	double bent (medium; R=78 mm)
319760	4076	419		10	6	250	180	155	140	125	105		14	SAE 1 1/2" 10 C	bent
326322	4032	426		10	1	250							x	SAE 1 1/2" 10 C	bent
326600	2760	426		10	1	140							14	SAE 1 1/2" 10 C	bent
326610	2761	426		10	1	140							14	SAE 1 1/2" 10 C	bent
326690	3069	426		10	2	180	150						w/o (L1: 14)	SAE 1 1/2" 10 C	bent
326865	4086	426		37	5	215	181	153	129	105			12,7	SAE J 498	bent
335850	2985	335		26	1	179							12	40x1.5 CSN 014950.1	bent
335870	2987	335		26	1	179							12	40x1.5 CSN 014950.1	bent
338970	2897	438		10	0									SAE 1 1/2" 10 C	bent
353660	3166	853		26	1	130							14	N42x1.5x9H DIN 5480	double bent (short; R=65 mm)
357630	3863	357		28	2	152	127						12,7	SAE 1 1/2" 28 C	double bent (long; R=100 mm)
357640	3864	357		28	2	152	127						12,7	SAE 1 1/2" 28 C	double bent (long; R=100 mm)
358010	2901	258		10	1	151							12,7	SAE 1 1/2" 10 C	double bent (medium; R=78 mm)
359770	3177	259		10	1	145							14	SAE 1 1/2" 10 C	double bent (medium; R=78 mm)
364650	2765	364		10	1	140							14	SAE 1 1/2" 10 C	double bent (long; R=100 mm)
364660	2766	364		10	1	140							14	SAE 1 1/2" 10 C	double bent (long; R=100 mm)
370520	2752	270		10	2	150	125						14	SAE 1 1/2" 10 C	double bent (short; R=65 mm)
375050	4105	375		25	1	150							16	JIS B 1602	double bent (short; R=65 mm)
375060	4106	375		25	1	150							16	JIS B 1602	double bent (short; R=65 mm)
376520	2752	476		10	1	150						14	14	SAE 1 1/2" 10 C	double bent (medium; R=78 mm)
376521	2752	476		10	1	140							14	SAE 1 1/2" 10 C	double bent (medium; R=78 mm)
376600	3860	476		26	1	145							12,7	N42x1.5x9H DIN 5480	double bent (medium; R=78 mm)

DIĞER ARAÇ MARKALI OTOMATİK FREN AYAR KOLLARININ TEKNİK LİSTESİ

AYS CODE	CASTING	CONTROL UNIT	APPLICATION	SPLINE TEETH	NO of HOLE	H1	H2	H3	H4	H5	H6	H7	BUSHING (mm)	SPLINE TYPE	CONTROL ARM
376610	3861	476		26	1	145							12,7	N42x1.5x9H DIN 5480	double bent (medium; R=78 mm)
380520	2752	480		26	1	145							14	N42x1.5x9H DIN 5480	double bent (short; R=65 mm)
394000	3900	294		10	1	145							14	SAE 1 1/2" 10 C	double bent (short; R=65 mm)
396920	3892	496		19	1	145							14	A38x34 DIN 5482	double bent (short; R=65 mm)
396930	3893	496		19	1	145							14	A38x34 DIN 5482	double bent (short; R=65 mm)
405260	3226	705		10	1	135							16	SAE 1 1/2" 10 C	double bent (short; R=65 mm)
410970	3897	510		26	1	145							14	N42x1.5x9H DIN 5480	double bent (medium; R=78 mm)
411630	3863	711		10	3	178	152	127					14	SAE 1 1/2" 10 C	double bent (long; R=100 mm)
411640	3864	711		10	3	178	152	127					14	SAE 1 1/2" 10 C	double bent (long; R=100 mm)
413010	2901	713		12	1	150							12,7	JIS D 2001 (35x12)	double bent (short; R=65 mm)
413020	2902	713		12	1	150							12,7	JIS D 2001 (35x12)	double bent (short; R=65 mm)
413521	2752	613		26	1	145							14	N42x1.5x12H DIN 5480	double bent (short; R=65 mm)
414260	3226	714		14	1	150							12,7	JIS D 2001 (40x14)	double bent (short; R=65 mm)
414640	3864	514		10	3	178	152	127					14	SAE 1 1/2" 10 C	double bent (short; R=65 mm)
416321	4032	616		10	4	250	180	150	120				14	SAE 1 1/2" 10 C	ays-saddle type
416760	4076	616		10	0									SAE 1 1/2" 10 C	ays-saddle type
416761	4076	616		37	6	250	180	165	150	135	120		14	SAE J 498	ays-saddle type
418260	3226	718		10	3	178	152	127					14 (L1: x)	SAE 1 1/2" 10 C	double bent (medium; R=78 mm)
432970	4097	632		10	4	155	141	125	106				14	SAE 1 1/2" 10 C	bent
435370	4037	635		10	1	130							14	SAE 1 1/2" 10 C	ays-saddle type
435490	3049	635		10	1	165							16	SAE 1 1/2" 10 C	ays-saddle type
435500	3050	635		10	1	165							16	SAE 1 1/2" 10 C	ays-saddle type
435530	2753	635		10	2	175	150						14	SAE 1 1/2" 10 C	ays-saddle type
435531	2753	635		10	1	155							14	SAE 1 1/2" 10 C	ays-saddle type
435532	2753	635		10	1	170							14	SAE 1 1/2" 10 C	ays-saddle type
435540	2754	635		10	2	175	150						14	SAE 1 1/2" 10 C	ays-saddle type
435541	2754	635		10	1	155							14	SAE 1 1/2" 10 C	ays-saddle type
435542	2754	635		10	1	170							14	SAE 1 1/2" 10 C	ays-saddle type
435761	4076	635		26	6	250	180	155	140	125	105		14	N42x1.5x9H DIN 5480	ays-saddle type
435762	4076	635		8	6	250	180	155	140	125	105		14	32 UNI 222	ays-saddle type
435764	4076	635		28	6	250	180	155	140	125	105		14	SAE 1 1/2" 28 C	ays-saddle type
436490	3049	736		26	1	165							14	N42x1.5x9H DIN 5480	double bent (short; R=65 mm)
436500	3050	736		26	1	165							14	N42x1.5x9H DIN 5480	double bent (short; R=65 mm)
442180	4018	742		26	1	145							14	N42x1.5x12H DIN 5480	double bent (medium; R=78 mm)
442190	4019	742		26	1	145							14	N42x1.5x12H DIN 5480	double bent (medium; R=78 mm)
444040	4104	744		10	1	140							12,7	SAE 1 1/2" 10 C	double bent (short; R=65 mm)
453700	4070	253		10	1	165							14	SAE 1 1/2" 10 C	double bent (medium; R=78 mm)
453710	4071	253		10	1	165							14	SAE 1 1/2" 10 C	double bent (medium; R=78 mm)
454600	3860	854		26	1	145							14	N42x1.5x9H DIN 5480	double bent (short; R=65 mm)
454610	3861	854		26	1	145							14	N42x1.5x9H DIN 5480	double bent (short; R=65 mm)
455940	2894	555		10	1	143							14	SAE 1 1/2" 10 C	double bent (medium; R=78 mm)
457522	2752	557		28	1	140							12,7	SAE 1 1/2" 28 C	double bent (short; R=65 mm)
457600	3860	557		10	1	145							12,7	SAE 1 1/2" 10 C	double bent (short; R=65 mm)
457610	3861	557		10	1	145							12,7	SAE 1 1/2" 10 C	double bent (short; R=65 mm)
461400	4040	261		14	2	165	135						12	JIS D 2001 (40x14)	bent
461401	4040	261		14	1	135							12	JIS D 2001 (40x14)	bent
461410	4041	261		14	2	165	135						12	JIS D 2001 (40x14)	bent
461411	4041	261		14	1	135							12	JIS D 2001 (40x14)	bent
466600	3860	266		10	1	145							12,7	SAE 1 1/2" 10 C	double bent (medium; R=78 mm)
466601	3860	266		26	1	145							12,7	N42x1.5x9H DIN 5480	double bent (medium; R=78 mm)
466610	3861	266		10	1	145							12,7	SAE 1 1/2" 10 C	double bent (medium; R=78 mm)
466611	3861	266		26	1	145							12,7	N42x1.5x9H DIN 5480	double bent (medium; R=78 mm)
467860	4086	567		10	5	215	181	153	129	105			14	SAE 1 1/2" 10 C	bent
468861	4086	568		10	5	215	181	153	129	105			14	SAE 1 1/2" 10 C	bent
470861	4086	570		10	1	118							14	SAE 1 1/2" 10 C	bent
471760	4076	171		10	6	250	180	155	140	125	105		14	SAE 1 1/2" 10 C	ays-saddle type



ABA
Automatic Brake Adjuster / Otomatik Fren Ayar Kolu.
S-ABA
(Self Setting) Automatic Brake Adjuster / Tam Otomatik Fren Ayar Kolu.

* CS > Customer Specific / Özel İmalat

PRODUCT PICTURES ARE TAKEN OF REFERENCE FOR CASTING BODIES. ALSO PLEASE IGNORE CONTROL UNIT & ITS POSITION. ÜRÜN FOTOĞRAFLARI GÖVDELER REFERANS ALINARAK YERLEŞTİRİLMİŞTİR. KİLİT VE KİLİT AÇILARINI DİKKATE ALMAYINIZ.

ALL ORIGINAL NUMBERS, MARKS AND MODELS FROM VEHICLE MANUFACTURERS LISTED IN THIS CATALOGUE ARE FOR COMPARISON PURPOSES ONLY AND MAY NOT BE USED IN INVOICES TO VEHICLE OWNERS OR RESELLERS. / ORJINAL ÜRÜN NUMARALARI MÜŞTERİYİ BİLGİLENDİRME VE ÜRÜNE REFERANS AMAÇLI KULLANILMIŞTIR.

THE TECHNICAL LIST OF BRAKE ADJUSTERS FOR OTHER BRANDED COMMERCIAL VEHICLES

AYS CODE	CASTING	CONTROL UNIT	APPLICATION	SPLINE TEETH	NO of HOLE	H1	H2	H3	H4	H5	H6	H7	BUSHING (mm)	SPLINE TYPE	CONTROL ARM
473600	2760	573		27	1	160							14	BNA 227 D3.5	double bent (short; R=65 mm)
473610	2761	573		27	1	160							14	BNA 227 D3.5	double bent (short; R=65 mm)
475770	4077	375		25	1	165							16	JIS B 1602 L=29.4	double bent (short; R=65 mm)
475780	4078	375		25	1	165							16	JIS B 1602 L=29.4	double bent (short; R=65 mm)
480850	3185	280		10	1	148,5							x,12	10 C -special	ays-straight
480851	3185	280		25	1	148,5							x,12	25 C -special	ays-straight
480860	3186	280		10	1	148,5							x,12	10 C -special	ays-straight
480861	3186	280		25	1	148,5							x,12	25 C -special	ays-straight
480870	3187	280		25	2	150	125						x,12	25 C -special	ays-straight
480871	3188	280		10	2	150	125						x,12	10 C -special	ays-straight
489520	2752	689		26	1	145							14	N42x1.5x9H DIN 5480	double bent (short; R=65 mm)
497850	4085	597		19	1	160							14	A38x34 DIN 5482	double bent (short; R=65 mm)
498040	4104	598		10	1	140							12,7	SAE 1 1/2" 10 C	bent
499680	3068	699		10	1	152							14	SAE 1 1/2" 10 C	bent
506850	4085	806		10	1	165							12,7	SAE 1 1/2" 10 C	double bent (medium; R=78 mm)
507601	2760	907		10	1	152							12,7	SAE 1 1/2" 10 C	bent
507611	2761	907		10	1	152							12,7	SAE 1 1/2" 10 C	bent
508680	3068	908		26	1	140							14	40x1.5 CSN 014950.1	bent
508690	3069	908		26	1	140							14	40x1.5 CSN 014950.1	bent
508901	4097	808		10	4	155	141	125	106				14	SAE 1 1/2" 10 C	ays-saddle type
508902	4097	808		10	4	152	140	127	115				14	SAE 1 1/2" 10 C	ays-saddle type
509040	4104	709		10	1	108							12,7	SAE 1 1/2" 10 C	double bent (short; R=65 mm)
510770	4077	810		10	1	145							12,7	SAE 1 1/2" 10 C	double bent (short; R=65 mm)
510780	4078	810		10	1	145							12,7	SAE 1 1/2" 10 C	double bent (short; R=65 mm)
519040	4104	319		10	1	125							12	SAE 1 1/2" 10 C	double bent (short; R=65 mm)
521040	4104	921		10	1	140							12,7	SAE 1 1/2" 10 C	bent
521530	2753	921		10	1	159							12,7	SAE 1 1/2" 10 C	bent
521531	2753	921		10	1	140							12,7	SAE 1 1/2" 10 C	bent
521540	2754	921		10	1	159							12,7	SAE 1 1/2" 10 C	bent
521541	2754	921		10	1	140							12,7	SAE 1 1/2" 10 C	bent
523850	4085	523		10	1	152							16	SAE 1 1/2" 10 C	double bent (long; R=100 mm)
526270	3226	627		10	1	125							12,7	SAE 1 1/2" 10 C	double bent (short; R=65 mm)
554040	4104	754		10	1	127							12,7	SAE 1 1/2" 10 C	double bent (short; R=65 mm)
557780	3878	557		26	1	145							14	N42x1.5x9H DIN 5480	double bent (short; R=65 mm)
557790	3879	557		26	1	145							14	N42x1.5x9H DIN 5480	double bent (short; R=65 mm)
560041	4104	860		25	1	125							12,7	JIS B 1602	double bent (short; R=65 mm)
561830	3883	854		20	1	130							14	A40x36 DIN 5482	double bent (short; R=65 mm)
561840	3884	854		20	1	130							14	A40x36 DIN 5482	double bent (short; R=65 mm)
563860	4086	763		10	1	125							12,7	SAE 1 1/2" 10 C	double bent (short; R=65 mm)
566690	3069	966		10	1	152							14	SAE 1 1/2" 10 C	bent
570760	4076	970		36	6	250	180	165	150	135	120		14	A30x34 DIN 5481	bent
581780	3878	781		26	1	145							14	N42x1.5x9H DIN 5480	double bent (short; R=65 mm)
581790	3879	781		26	1	145							14	N42x1.5x9H DIN 5480	double bent (short; R=65 mm)
582760	4076	782		10	6	250	180	155	140	125	105		14	SAE 1 1/2" 10 C	double bent (short; R=65 mm)
582780	3878	782		28	1	145							14	SAE 1 1/2" 28 C	double bent (short; R=65 mm)
582790	3879	782		28	1	145							14	SAE 1 1/2" 28 C	double bent (short; R=65 mm)
584780	3878	684		26	1	145							14	N42x1.5x9H DIN 5480	double bent (short; R=65 mm)
584790	3879	684		26	1	145							14	N42x1.5x9H DIN 5480	double bent (short; R=65 mm)
585620	3162	785		26	1	145							14	N42x1.5x9H DIN 5480	double bent (medium; R=78 mm)
585621	3162	785		10	1	145							14	SAE 1 1/2" 10 C	double bent (medium; R=78 mm)
585630	3163	785		26	1	145							14	N42x1.5x9H DIN 5480	double bent (medium; R=78 mm)
585631	3163	785		10	1	145							14	SAE 1 1/2" 10 C	double bent (medium; R=78 mm)
588960	2752	588		10	2	160	140						12,7	SAE 1 1/2" 10 C	ays-saddle type
589950	3195	789		10	1	115							14	SAE 1 1/2" 10 C	double bent (medium; R=78 mm)
589960	3196	789		10	1	115							14	SAE 1 1/2" 10 C	double bent (medium; R=78 mm)
590041	4104	990		10	2	140	115						12,7	SAE 1 1/2" 10 C	bent

REPAIR KITS / TAMİR TAKIMLARI



AYS CODE	OEM	PART NUMBER	AYS CODE	OEM	PART NUMBER
200000	0004200092	76046	200000	3091286	76046
200000	324728	76046	200000	324729	76046
200000	0004200092	76046	200000	0004200092	76046
200000	1276868	76046	200000	0004200092	76046
200000	1350817	76046	200000	5001825536	76046
200000	179979	76046	200000	5815183410	76046
200000	272800	76046	200000	76016	76046
200000	4W0900	76046	200000	76017	76046
200000	5465310099	76046	200000	81506106132	76046
200000	976017	76046	200000	84890	76046
200000	FBU7869	76046	200000	86573	76046
200000	FBU3728	76046	200000	FBU3726	76046

AYS CODE 200000

AYS CODE	CONTROL UNIT	AYS CODE	CONTROL UNIT	AYS CODE	CONTROL UNIT	AYS CODE	CONTROL UNIT	AYS CODE	CONTROL UNIT	AYS CODE	CONTROL UNIT	AYS CODE	CONTROL UNIT	AYS CODE	CONTROL UNIT
100103	161	100151	435	100199	688	100247	891	100295	265	100343	493	100391	711	100439	905
100104	171	100152	439	100200	689	100248	899	100296	266	100344	496	100392	713	100440	907
100105	176	100153	442	100201	690	100249	900	100297	267	100345	499	100393	714	100441	918
100106	226	100154	443	100202	692	100250	908	100298	268	100346	501	100394	716	100442	919
100107	227	100155	444	100203	696	100251	911	100299	269	100347	505	100395	718	100443	921
100108	229	100156	448	100204	704	100252	915	100300	273	100348	510	100396	720	100444	926
100109	230	100157	451	100205	710	100253	920	100301	290	100349	514	100397	723	100445	927
100110	232	100158	453	100206	719	100254	954	100302	291	100350	515	100398	724	100446	934
100111	235	100159	455	100207	725	100255	958	100303	292	100351	561	100399	729	100447	936
100112	250	100160	472	100208	731	100256	972	100304	299	100352	567	100400	732	100448	938
100113	253	100161	474	100209	733	100257	985	100305	303	100353	568	100401	737	100449	946
100114	255	100162	475	100210	735	100258	988	100306	306	100354	571	100402	738	100450	949
100115	258	100163	476	100211	736	100259	991	100307	309	100355	572	100403	742	100451	953
100116	259	100164	477	100212	760	100260	992	100308	310	100356	574	100404	746	100452	957
100117	262	100165	478	100213	761	100261	169	100309	316	100357	575	100405	747	100453	962
100118	270	100166	479	100214	765	100262	196	100310	359	100358	578	100406	748	100454	963
100119	272	100167	480	100215	765	100263	202	100311	360	100359	580	100407	754	100455	966
100120	274	100168	482	100216	768	100264	206	100312	361	100360	581	100408	756	100456	969
100121	281	100169	485	100217	778	100265	207	100313	365	100361	590	100409	758	100457	970
100122	282	100170	489	100218	782	100266	244	100314	367	100362	592	100410	763	100458	971
100123	284	100171	507	100219	784	100267	248	100315	371	100363	594	100411	767	100459	978
100124	293	100172	508	100220	785	100268	260	100316	376	100364	595	100412	770	100460	981
100125	294	100173	509	100221	787	100269	298	100317	378	100365	598	100413	771	100461	983
100126	295	100174	511	100222	788	100270	145	100318	380	100366	599	100414	774	100462	987
100127	304	100175	512	100223	789	100271	147	100319	386	100367	611	100415	775	100463	989
100128	335	100176	521	100224	798	100272	148	100320	403	100368	613	100416	777	100464	990
100129	357	100177	555	100225	799	100273	151	100321	405	100369	614	100417	781	100465	994
100130	362	100178	556	100226	802	100274	164	100322	406	100370	618	100418	800	100466	616
100131	364	100179	557	100227	807	100275	165	100323	413	100371	619	100419	801	100467	635
100132	372	100180	558	100228	808	100276	167	100324	416	100372	620	100420	803	100468	565
100133	373	100181	559	100229	809	100277	172	100325	418	100373	622	100421	806	100469	616
100134	374	100182	560	100230	812	100278	174	100326	425	100374	624	100422	814	100470	853
100135	374	100183	564	100231	813	100279	175	100327	426	100375	627	100423	851	100471	808
100136	385	100184	565	100232	816	100280	181	100328	431	100376	628	100424	855	100472	308
100137	389	100185	566	100233	854	100281	187	100329	432	100377	634	100425	863	100473	313
100138	390	100186	570	100234	860	100282	189	100330	433	100378	636	100426	866	100474	321
100139	401	100187	573	100235	861	100283	190	100331	438	100379	637	100427	867	100475	338
100140	402	100188	579	100236	862	100284	199	100332	447	100380	680	100428	869	100476	354
100141	404	100189	597	100237	864	100285	203	100333	456	100381	684	100429	878	100477	375
100142	410	100190	608	100238	865	100286	204	100334	459	100382	685	100430	883	100478	523
100143	411	100191	616	100239	868	100287	233	100335	460	100383	687	100431	886	100479	730
100144	412	100192	617	100240	871	100288	236	100336	469	100384	691	100432	888	100480	744
100145	414	100193	621	100241	872	100289	240	100337	471	100385	693	100433	890	100481	769
100146	419	100194	632	100242	877	100290	246	100338	473	100386	699	100434	893	100482	810
100147	422	100195	633	100243	881	100291	251	100339	483	100387	702	100435	894	100483	870
100148	424	100196	635	100244	884	100292	257	100340	486	100388	705	100436	895	100484	909
100149	427	100197	682	100245	885	100293	261	100341	488	100389	707	100437	902	100485	616
100150	434	100198	686	100246	887	100294	263	100342	491	100390	709	100438	903		



ABA
Automatic Brake Adjuster / Otomatik Fren Ayar Kolu.
S-ABA
(Self Setting) Automatic Brake Adjuster / Tam Otomatik Fren Ayar Kolu.

* CS > Customer Specific / Özel İmalat

PRODUCT PICTURES ARE TAKEN OF REFERENCE FOR CASTING BODIES. ALSO PLEASE IGNORE CONTROL UNIT & ITS POSITION. ÜRÜN FOTOĞRAFLARI GÖVDELER REFERANS ALINARAK YERLEŞTİRİLMİŞTİR. KİLİT VE KİLİT AÇILARINI DİKKATE ALMAYINIZ.

ALL ORIGINAL NUMBERS, MARKS AND MODELS FROM VEHICLE MANUFACTURERS LISTED IN THIS CATALOGUE ARE FOR COMPARISON PURPOSES ONLY AND MAY NOT BE USED IN INVOICES TO VEHICLE OWNERS OR RESELLERS. / ORJINAL ÜRÜN NUMARALARI MÜŞTERİYİ BİLGİLENDİRME VE ÜRÜNE REFERANS AMAÇLI KULLANILMIŞTIR.

AYS CODE - AYS S-ABA CODE - PART NUMBER

AYS CODE	AYS S-ABA CODE	PART NUMBER	PAGE NO	AYS CODE	AYS S-ABA CODE	PART NUMBER	PAGE NO	AYS CODE	AYS S-ABA CODE	PART NUMBER	PAGE NO
202170	801945	79404	182	231400	801880	cs	112	246601	801465	79127	182
202170	801945	79404	182	231500	802660	72745	112	246610	801450	79520	182
202180	801950	79405	182	231600	802665	72744	112	246611	801455	79521	182
203170	801935	79407	122	231700	801895	72665	112	247530		79266	151
203180	801940	79408	122	231800	801900	72666	112	247540		79265	151
204490		79662	123	231900	801895	72952	113	247600	802160	79158	160
204500		79663	123	232000	801900	72951	113	247610	802165	79159	160
204790		79398	123	232100	801895	72954	113	248010	800955	79138	158
204800		79399	123	232200	801900	72955	113	248020	800960	79139	158
206010	801090	79412	182	232300	801855	72949	113	248710		79146	158
206020	801095	79413	182	232400	801860	72950	113	248720		79147	158
206850	800150	79416	182	233200		79348	113	248940		79140	182
207050		79418	182	233210		79347	113	248950		79141	182
207060		79417	182	235400		72825	113	248970	803600	79148	159
210000	800070	79005	139	235410		72826	113	250100	801560	70706	98
210000	800070	79326	139	235830	801650	79442	113	250200	801850	70775	98
210000	800070	79331	139	235840	801655	79443	113	250400	801725	70754	98
210016	803670	79552	182	236600	802440	72634	133	250500	801700	72812	98
210030	800070	79006	139	236610	802445	72633	133	250520	803180	79444	179
210030	800070	79332	139	240101	801755	72544	116	250600	801705	72811	98
210200	803775	72758	143	240200	801820	72527	116	250601	802260	79142	182
210400	802955	cs	178	240201	801760	72545	117	250610	802265	79143	182
210500	802955	cs	178	240300	801755	72695	117	250690	801305	79145	159
210700	800410	cs	139	240400	801760	72696	117	250700	801700	72810	98
210800		72203	152	240500	800775	cs	117	250800	801705	72809	98
210804		79429	177	240600	800785	72540	117	250900	801825	72173	98
210900		72204	153	240601	800755	72530	117	251000	801830	72174	98
210902		79430	177	240700	800780	72547	117	251100	801815	cs	98
210905	801840	72177	153	240800	800780	72309	117	251200	801820	cs	98
220100	801520	79013	131	240902	800750	70871	117	251300	801795	70918	98
220105	801490	79286	131	240970	803610	79114	169	251400	801800	70917	99
220200	801525	79014	131	240970	803610	79114	169	251500	800010	70953	99
220203	801495	79287	131	241100	802920	72534	117	251550	800555	70527	164
220301	801510	79015	131	241200	803420	72529	117	251560	800560	70526	164
220304	801500	79535	131	241201	802930	72546	117	251600	800005	70952	99
220400	801515	79016	131	241300	802960	cs	118	251700	800275	72596	99
220403	801505	79536	132	241500	800780	72541	118	251800	802575	72596	99
220500	803460	79011	132	241600	802090	70824	118	251900	801740	70954	99
220600	803455	79012	132	241700	802095	70825	118	251900	802575	72059	99
220700	802460	79289	132	241800	802050	72525	118	252000	801570	72213	99
220800	802465	79288	132	241900	802055	72526	118	252100	800020	72063	99
220900	802440	79018	132	242000	802200	72532	118	252200	800015	72062	99
220902	802430	79299	132	242001	802050	72523	118	252300	802575	79185	99
221000	802445	79017	132	242100	802205	72533	118	252400	801710	cs	99
221002	802435	79300	132	242101	802055	72524	118	252500	801715	cs	99
221100	802460	79304	132	242200	802590	72537	118	252600	801710	cs	100
221200	802465	79305	132	242201	802640	72543	118	252700	801715	cs	100
221300	801550	79009	132	242300	802595	72536	119	252800	800010	72616	100
221400	801555	79010	133	242301	802645	72542	119	252900	800005	72617	100
221500	801520	79020	133	242400	802590	72311	119	253000	800020	72594	100
221600	801525	79021	133	242500	802595	72310	119	253101	800015	72593	100
221700	803470	79303	133	242600	801590	72538	119	253200	800010	79073	100
230100	800790	72662	111	242604	801580	79179	119	253300	800005	79074	100
230200	800815	72947	147	242700	801595	72539	119	253400	800485	79137	100
230300	801855	72660	111	242705	801585	79180	119	253500	800490	79136	100
230400	801860	72661	111	242800	801590	72302	119	253600	800020	72235	100
230500	801855	cs	111	242900	801595	72301	119	253700	800015	72234	100
230600	801860	cs	111	243000	800755	72535	119	253800	801825	72919	101
230700	801895	72664	112	243100	802930	72531	119	253900	801830	72920	101
230800	801900	72663	112	243200	802590	72680	120	254000	801825	72069	101
230900	801290	79249	112	243300	802595	72679	120	254100	801830	72070	101
231000	801295	79248	112	243400	801280	72833	120	254200	801825	79099	101
231100	803070	72654	112	243500	801285	72834	120	254300	801830	79100	101
231200	802855	72910	112	245940		72560	163	254400	802580	72056	101
231300	801875	cs	112	245950		72559	163	254500	802540	72060	101
				246600	801460	79126	182	254600	802545	72061	101

AYS CODE - AYS S-ABA CODE - PART NUMBER

AYS CODE	AYS S-ABA CODE	PART NUMBER	PAGE NO	AYS CODE	AYS S-ABA CODE	PART NUMBER	PAGE NO	AYS CODE	AYS S-ABA CODE	PART NUMBER	PAGE NO
254780	801565	70706	182	281200	801725	cs	106	305600	802250	70511	164
254780	801565	cs	182	281300	801735	cs	106	305610	802255	70512	164
255520	803330	cs	182	281400	801735	79212	106	306010	800995	79434	182
259940		72604	133	281500	801805	79208	106	306020	801000	79435	182
260100	802490	72724	124	281600	801810	79209	106	306650		70620	134
260101	802520	72783	124	281900		79203	106	306660		70619	134
260200	802495	72723	125	282000		79204	107	306870	800675	79359	127
260201	802525	72782	125	282101	800875	79215	107	306880	800680	79360	127
260300	802840	72725	125	282200		79225	107	308260	800715	79724	128
260400	802840	72905	125	282300		79226	107	309680	801350	72618	170
260600	802960	cs	125	282400		cs	107	309870	800675	79713	128
260700	802970	cs	125	282500		cs	107	309880	800680	79714	128
260800	803070	79178	125	282600		cs	107	310040	802915	72393	153
260900	802905	70859	151	282700		cs	107	310100	800770	72778	161
261000	803080	72909	125	282800	800010	79205	107	310200	803580	72871	146
261100	802880	72678	125	282900	800005	79206	107	310600	803320	72408	147
261200	802980	72726	125	283000		79217	107	310601	802410	79510	175
261300	802610	72669	125	283100		79216	107	310610	802415	79511	175
261301	802620	72671	125	283200	803415	79218	108	310800	803280	12256	161
261400	802615	72668	126	283300	803425	72208	108	311040	802755	72189	151
261401	802625	72670	126	283300	803425	79207	108	311500	803190	72554	140
261500	802915	70946	126	283400	800870	cs	108	311520	802765	72190	151
261600	802940	72517	126	283500	800010	cs	108	311680	801320	79641	128
261700	802600	70832	126	283600	800005	cs	108	311690	801325	79642	128
261710	802605	70833	126	283700	801720	70753	101	312040	803535	72599	134
261800	802630	cs	126	287460		79283	161	312041	803530	72601	134
264010	801015	10283	182	287470		79282	161	312500	800655	79567	182
264020	801020	10284	182	290103		72054	101	312510	800660	79568	182
264530		79402	171	290200		70772	101	312600	802380	70718	143
264540		79403	171	290300		70771	102	312601	802370	72014	143
264600	802340	12254	161	290600	801430	79345	181	312610	802385	70719	143
264610	802345	12255	161	290601	801435	79344	181	312611	802375	72015	143
264850	803345	72928	171	296010	801090	79414	182	312630		72879	147
265660		79368	114	296020	801095	79415	182	312631		72881	148
265670		79369	114	299170	801915	79394	123	312640		72880	148
267520	800405	cs	179	299180	801920	79395	123	312641		72882	148
267900	800070	79240	139	301520	803200	72448	147	312650		72916	128
267900	800070	79343	139	302510		70544	133	312660		72915	128
269850	803510	79274	182	302511		70800	150	312680	801340	72945	148
270100	801080	72583	176	302520		70545	133	312681	801310	79030	147
270200	801085	72584	176	302521		70799	150	312690	801345	72946	148
270300	800860	72585	176	302530		72675	126	312691	801315	79031	147
271600		cs	176	302531		70542	133	312850	801785	79107	171
271610		cs	176	302540		72674	126	312860	801790	79108	171
272520	803405	79255	182	302541		70543	133	312970		70996	146
273520	803360	cs	180	302560		79150	133	313260	800820	79353	182
274680	800300	79269	159	302570		79151	134	313310		70880	134
274690	800295	79270	158	302650		72673	127	313320		70881	134
275770		79260	162	302651		72718	127	313510		70975	134
275780		79261	162	302652		72907	127	313520		70976	134
276261	800905	79461	155	302660		72672	127	313630		79088	182
276520	803335	cs	182	302661		72717	127	314260	800795	72030	147
280100	801630	cs	105	302662		72906	127	314520	803170	70882	173
280200	801635	cs	105	303330		70608	134	314521	803215	70883	173
280300	801630	79223	105	303340		70609	134	314522	803125	70886	173
280400	801635	79224	105	303960		79186	102	314523	803550	70979	157
280500	801700	79229	105	304520	803545	70687	143	314524	803145	72031	157
280600	801705	79228	106	304650		72898	127	314525	803150	72103	157
280700	801700	79220	106	304651		72901	127	314526	802915	79169	155
280800	801705	79219	106	304660		72897	127	314970		70884	172
280900	801720	79210	106	304661		72902	127	316520	803385	79543	182
281000	801725	79211	106	304710		72426	143	316680	801470	70621	134
281040	801865	79677	126	304720		72427	143	316690	801475	70622	135
281050	801870	79678	126	304850	803435	72205	162	318530		79152	135
281100	801720	cs	106	305040	802770	70510	164	318540		79153	135



ABA
Automatic Brake Adjuster / Otomatik Fren Ayar Kolu.
S-ABA
(Self Setting) Automatic Brake Adjuster / Tam Otomatik Fren Ayar Kolu.

* CS > Customer Specific / Özel İmalat

PRODUCT PICTURES ARE TAKEN OF REFERENCE FOR CASTING BODIES. ALSO PLEASE IGNORE CONTROL UNIT & ITS POSITION. ÜRÜN FOTOĞRAFLARI GÖVDELER REFERANS ALINARAK YERLEŞTİRİLMİŞTİR. KİLİT VE KİLİT AÇILARINI DİKKATE ALMAYINIZ.

ALL ORIGINAL NUMBERS, MARKS AND MODELS FROM VEHICLE MANUFACTURERS LISTED IN THIS CATALOGUE ARE FOR COMPARISON PURPOSES ONLY AND MAY NOT BE USED IN INVOICES TO VEHICLE OWNERS OR RESELLERS. / ORJINAL ÜRÜN NUMARALARI MÜŞTERİYİ BİLGİLENDİRME VE ÜRÜNE REFERANS AMAÇLI KULLANILMIŞTIR.

AYS CODE - AYS S-ABA CODE - PART NUMBER

AYS CODE	AYS S-ABA CODE	PART NUMBER	PAGE NO	AYS CODE	AYS S-ABA CODE	PART NUMBER	PAGE NO	AYS CODE	AYS S-ABA CODE	PART NUMBER	PAGE NO
319040	802915	70823	120	330000	801825	72937	156	359650		70949	141
319530		72720	128	330100	801830	72938	156	359770	801730	cs	182
319540		72719	128	330200	800895	72864	156	359850	803540	72600	135
319760	800070	cs	182	330300	800885	72180	156	360000	803090	70530	165
320000	800055	72703	148	330400	800885	72199	156	360020	801835	cs	162
320000	800055	79327	148	330500	800890	79184	156	360100	803095	70634	165
320134	800055	72875	148	330600	801885	79349	156	360200	803100	70945	165
320135	803695	cs	148	330700	801890	79350	156	360530		72217	170
320136	803695	cs	148	331510		72033	155	360540		72218	170
320137	800430	cs	148	331520		72034	155	360680	801390	72216	170
320138		cs	148	332900		72035	155	360690	801395	72215	170
320234	800055	72263	148	333220		70624	164	360760	800060	72883	149
320234	800055	72876	148	334710		70626	164	361520	802900	72149	179
320400	803350	79056	171	334720		70627	164	361760	800070	79160	129
320500	801330	72884	149	335600	802210	70840	164	361970	800060	79183	172
320600	801335	72885	149	335610	802215	70841	165	362260	800720	72198	174
320900	800070	72702	140	335850	802700	79691	182	362520	803045	72144	151
321100	803185	79090	140	335870	802705	79692	182	362521	803520	79082	169
321200	803675	72645	140	338970		70643	182	362522	803505	79092	169
321300	803210	72053	140	338971		70865	173	362600	802190	72150	120
321400	801340	70969	140	338972		70980	180	362610	802195	72151	120
321500	801345	70970	140	339520	803500	72376	143	362850	803045	72568	156
322520	803105	70678	149	340000	802960	cs	157	363800		70955	102
322521	803155	72334	140	342520	803195	70787	165	363810		70956	102
322522	803105	70678	149	342522	803195	72086	165	364260	800765	72558	120
322550	800535	79065	177	342850	803040	70660	165	364600	802390	72370	144
322560	800540	79066	177	343520	803100	72563	165	364610	802395	72371	144
322600	802480	12112	175	344040	800250	79267	169	364650		79181	182
322601	802300	70802	140	344852	803525	79268	181	364660		79182	182
322602	802100	72917	172	347650		72714	128	365040	802830	72364	154
322610	802485	12113	175	347660		72713	128	365041	802900	72644	154
322611	802305	70803	140	348260	800830	72016	143	365600	802180	79156	154
322612	802105	72918	172	348380		72785	128	365610	802185	79157	154
322680	801310	70768	149	348390		72784	129	366630		72238	141
322760	800055	72763	140	350100	803545	70989	143	366640		72239	141
322850	803305	72214	170	350300	802670	72017	143	367260	800740	79428	129
324521	803105	12307	176	350400	802675	72018	144	367400		72958	114
324523	803565	72154	167	351500		79272	150	367410		72959	114
324524	803185	72249	114	351501		79273	150	368040	802900	70986	154
325520	803175	70532	164	351700	800070	79149	159	369040	802900	72643	175
325550	800565	70583	164	353261	800790	72963	114	369160		72064	102
325560	800570	70582	164	353660		70708	182	369161		72127	102
326320	800055	72253	149	353680	801410	79491	169	369170		72065	102
326321	800055	72271	140	353690	801415	79492	170	369171		72128	102
326322	803780	72272	182	353851	803075	72962	114	369780	800495	cs	108
326530		12351	180	353910	803070	72953	114	369790	800500	cs	108
326540		12350	180	354260	800725	72179	156	370000		72452	152
326600	802100	12141	182	356600	802140	70977	129	370100		72453	152
326610	802105	12142	182	356610	802145	70978	129	370520	802975	cs	182
326690	801315	79055	182	357010	801185	70926	150	371630		72007	141
326860	803725	72251	159	357011	801180	70928	150	371640		72008	141
326861	803765	72259	172	357012	801035	72137	135	371770	801735	70805	102
326862	800070	72261	169	357020	801190	70927	150	373170	802020	72206	162
326863	800075	72267	157	357021	801040	72138	135	373180	802025	72207	162
326864	803655	72268	157	357260	800720	72019	165	373530		72461	145
326865	803770	72273	182	357261	800735	72114	174	373540		72462	145
327041	802905	72457	155	357263	800895	72181	156	373600	802170	79258	162
327600	802060	70893	151	357264	800910	79682	156	373610	802175	79259	162
327601	802210	72140	152	357600	802040	10937	153	373680	801360	72646	145
327602	802080	72815	120	357610	802045	10938	153	373960	800005	70992	102
327610	802065	70894	151	357630		79503	182	373970	800010	70993	102
327611	802215	72141	152	357640		79504	182	374260	800810	72837	159
327612	802085	72816	120	357940		70838	150	374261	800760	72182	179
327850	801765	70930	152	357950		70839	150	374530		79064	160
327860	801770	70931	152	358010	800935	72344	182	374540		79063	160

AYS CODE - AYS S-ABA CODE - PART NUMBER

AYS CODE	AYS S-ABA CODE	PART NUMBER	PAGE NO	AYS CODE	AYS S-ABA CODE	PART NUMBER	PAGE NO	AYS CODE	AYS S-ABA CODE	PART NUMBER	PAGE NO
375050		79250	182	400100	803165	70576	173	427950	802445	79307	136
375060		79251	182	401830		79625	115	428400		72929	177
376520	802965	cs	182	401840		79453	115	428400		79462	177
376521	802920	cs	182	402850	803340	79121	171	429850	803030	79658	181
376600	802530	cs	182	405260	800730	72779	183	430000	803315	70762	174
376610	802535	cs	183	405500	800455	72893	115	430100	803315	70764	174
376850	803285	72356	174	405510	800460	72892	115	430830	801650	79786	115
377350		72211	102	407170	802005	79292	135	430840	801655	79787	115
377360		72212	103	407180	802010	79293	135	431260	800885	12132	157
378530		72760	175	407680	801270	79639	123	432320	800070	72250	141
378540		72759	175	407690	801275	79640	124	432830	801640	79550	115
378660		70759	103	407850	801745	72521	124	432840	801645	79551	115
378850	803065	79501	123	407860	801750	72522	124	432860	800065	72266	158
380000	800465	72688	177	409850	803300	72804	171	432861	800070	72270	141
380100	800470	72689	177	410000	801300	79144	159	432862	800080	72254	176
380300	802570	72872	177	410002	801405	72803	171	432970	800070	72999	183
380400	801380	72930	177	410850	803295	72828	171	433170	801985	79296	136
380400	801380	79463	177	410960		72650	108	433171		cs	136
380501	801365	72647	145	410970		72651	183	433180	801990	79297	136
380520	803425	72208	183	411320	803585	72733	160	433181		cs	136
380540		72357	168	411630		12194	183	434420	801610	79499	176
380550		72358	168	411640		12195	183	434430	801615	79500	176
382770	801735	70867	103	412620	801700	72732	108	435300	800070	72948	141
383710		72432	165	412630	801705	72731	108	435300	800070	79330	141
383720		72433	165	413010	800985	72818	183	435370	801575	cs	183
384040	802760	72085	129	413020	800990	72819	183	435490		cs	183
384850	803025	72329	160	413520	803425	72865	108	435500		cs	183
384850	803025	79696	160	413521	803425	79695	183	435530		cs	183
385600	802350	72591	144	414010	800975	72869	159	435531		cs	183
385610	802355	72592	144	414020	800980	72870	159	435532		cs	183
385710		72439	165	414260	800825	72820	183	435540		cs	183
385720		72440	166	414640		79089	183	435541		cs	183
385850	802935	72428	123	414850	803015	70957	129	435542		cs	183
385851	802635	79372	123	415320	803705	12356	161	435700		79024	121
385860	803645	79643	123	416080	801490	79301	136	435710		79025	121
386220		72441	166	416090	801495	79302	136	435760	803685	cs	141
386850	802935	72429	123	416321	800060	79284	183	435761	803715	cs	183
388170	802005	79290	135	416760	803700	cs	183	435762	803585	cs	183
388180	802010	79291	135	416761		cs	183	435763		cs	158
389600	802460	cs	135	417701	800270	79649	159	435764		cs	183
389610	802465	cs	135	418260	800800	72827	183	435800	800075	72274	174
390000	800840	79079	171	418770		72886	120	435800	800075	79004	174
390220		72096	103	418780		72887	120	435800	800075	79630	174
390230		72097	103	419040	803250	72896	175	435802	800065	79022	158
390620	801680	cs	114	420000	801400	72802	171	435803	800080	79023	176
390621	801685	cs	114	420010	801150	72867	168	435804	800070	79035	141
390710		72727	114	420020	801155	72868	168	435804	800070	79333	141
390720		72728	114	420970	800140	72853	161	435900	803605	79091	169
391250		72120	103	421490		79577	121	435971	800050	cs	141
391260		72121	103	421500		79578	121	436490		79396	183
391330		72402	166	422580		72742	176	436500		79397	183
391331		72404	166	422590		72743	176	436550	800635	12313	161
391340		72401	166	423010	801100	72856	179	436560	800640	12314	162
391341		72403	166	423020	801105	72857	179	437520	803110	70752	179
392850	803425	79132	103	423170	801995	79474	136	437550	800595	79097	173
393260	800915	79080	172	423180	802000	79475	136	437560	800610	79098	173
394000	802560	cs	183	423850	803290	79371	121	437600	802310	79028	175
396920	800510	79241	183	424220		79546	179	437610	802315	79029	175
396930	800505	79242	183	424230		79547	179	437860	803640	79051	173
398520	802970	72570	179	424810		79059	163	438700	803575	79111	151
398860	803635	72359	172	424820		79060	163	438701	800070	79112	169
399830		72730	115	425260	800805	72862	174	438920		79727	163
399840		72729	115	427170	801985	79440	136	438930		79728	163
399860	803650	72260	172	427180	801990	79441	136	442180	800020	79725	183
400010	800070	79109	172	427940	802440	79306	136	442190	800015	79726	183



ABA
Automatic Brake Adjuster / Otomatik Fren Ayar Kolu.
S-ABA
(Self Setting) Automatic Brake Adjuster / Tam Otomatik Fren Ayar Kolu.

* CS > Customer Specific / Özel İmalat

PRODUCT PICTURES ARE TAKEN OF REFERENCE FOR CASTING BODIES. ALSO PLEASE IGNORE CONTROL UNIT & ITS POSITION. ÜRÜN FOTOĞRAFLARI GÖVDELER REFERANS ALINARAK YERLEŞTİRİLMİŞTİR. KİLİT VE KİLİT AÇILARINI DİKKATE ALMAYINIZ.

ALL ORIGINAL NUMBERS, MARKS AND MODELS FROM VEHICLE MANUFACTURERS LISTED IN THIS CATALOGUE ARE FOR COMPARISON PURPOSES ONLY AND MAY NOT BE USED IN INVOICES TO VEHICLE OWNERS OR RESELLERS / ORJINAL ÜRÜN NUMARALARI MÜŞTERİYİ BİLGİLENDİRME VE ÜRÜNE REFERANS AMAÇLI KULLANILMIŞTIR.

AYS CODE - AYS S-ABA CODE - PART NUMBER

AYS CODE	AYS S-ABA CODE	PART NUMBER	PAGE NO	AYS CODE	AYS S-ABA CODE	PART NUMBER	PAGE NO	AYS CODE	AYS S-ABA CODE	PART NUMBER	PAGE NO
444040	802885	72935	183	471601	802050	72586	122	497520	802740	72419	174
446530		79057	163	471610	802245	10715	150	497680	801420	72446	180
446540		79058	163	471611	802055	72587	122	497690	801425	72447	180
447170	801975	79476	137	471760	803685	79346	183	497850	803310	72750	184
447180	801980	79477	137	472850	803290	72641	177	498040	800275	72425	184
448260	800880	12310	162	473040	803455	79019	137	498970		70615	110
436850	801825	79002	124	473600	802420	79683	184	499040	803415	72438	110
436860	801830	79003	124	473610	802425	79684	184	499680	801230	72821	184
451970	800070	79542	159	474680	801240	79455	180	500170	801995	70897	138
453700		cs	183	474690	801245	79456	180	500180	802000	70896	138
453710		cs	183	474790		12206	168	500460		72338	110
454600	802550	cs	183	474800		12207	168	500461		79214	110
454610	802555	cs	183	474850	803425	79193	109	500470		72337	110
455650		72608	121	474851	803275	72385	178	500471		79213	110
455660		72609	121	475490		72178	103	500520	803000	70905	145
455770		72704	121	475770		79763	184	500530		72459	145
455771		72794	121	475780		79764	184	500540		72460	145
455780		72705	121	478420	801600	79637	178	500851	803290	72330	145
455781		72795	121	478430	801605	79638	178	500870	800685	79163	145
455940		72551	183	478860	803570	70892	155	500871	800705	79166	146
457520	803355	cs	181	479170	802005	79628	137	500880	800690	79162	146
457522	803490	cs	183	479180	802010	79629	137	500881	800710	79165	146
457600	802500	cs	183	480010	801170	72566	168	501680		72597	104
457610	802505	cs	183	480020	801175	72567	168	501690		72598	104
457852	803085	72553	121	480160		72931	178	502040	802840	72362	154
458040	802920	72550	122	480170		72932	178	502041	802915	72367	154
459040		72602	137	480850		cs	184	502042	802790	10939	154
459050		72603	137	480851		cs	184	502940		70872	122
461400		79351	183	480860		cs	184	503040	800275	72333	157
461401		cs	183	480861		cs	184	503600	802275	79043	142
461410		cs	183	480870		cs	184	503610	802285	79044	142
461410		79352	183	480871		cs	184	503650		79038	142
461411		cs	183	481600	802330	79493	169	503660		79039	142
461650		72548	122	481610	802335	79494	169	503830		79087	142
464140		79200	108	484920	800025	72037	104	503840		79086	142
464150		79199	109	484921	800510	72855	178	504260	800730	72777	160
464700	801630	72508	109	484930	800030	72036	104	505860	803760	72104	158
464710	801635	72509	109	484931	800505	72854	178	506850	803045	79071	184
465780	800485	cs	103	485100	800035	72040	104	507600	802320	70641	129
465790	800490	cs	103	485110	800040	72041	104	507601	802130	72806	184
465850	801805	72303	109	485680	801210	79068	124	507602	802070	72912	129
465852	801805	79514	109	485690	801215	79069	124	507603	802220	72914	129
465860	801810	72304	109	487040		72038	104	507610	802325	70642	129
465862	801810	79515	109	487050		72039	104	507611	802135	72805	184
466600	802510	cs	183	488790	800005	72013	109	507612	802220	72904	129
466601	802530	cs	183	489520	803425	72578	184	507680	801220	79698	130
466610	802515	cs	183	489521	803425	79227	109	507690	801225	79697	130
466611	802535	cs	183	490320	803775	72416	144	507850	803015	72903	130
466770	801735	72322	109	490520	803430	cs	109	507851	803080	72913	130
467860	803650	72262	183	491520	803560	70959	158	508261	800900	79177	170
468860	803170	72256	173	492520	803210	72710	142	508600	802450	72431	175
468861	800070	72265	183	492600	802180	72417	157	508610	802455	72430	175
469240	801740	72046	103	492610	802185	72418	157	508680	801440	12243	184
470040	802890	70851	124	492680	801200	79170	154	508690	801445	12244	184
470320	800070	72863	141	492690	801205	79171	154	508701	803670	79619	174
470860	800080	72269	142	493520	803205	70804	160	508900	800060	72788	173
470861	803590	72569	183	494710		72420	166	508900	800060	79235	173
470862	803620	72576	142	494720		72421	166	508901	800070	79393	184
470863	800060	72258	142	495220		72422	166	508902	800060	79459	184
470863	800060	72581	142	496170	801985	79294	137	509040		cs	184
470863	800060	79324	142	496171	802005	79581	137	509520	803280	72697	170
470870	800435	79052	142	496172		cs	137	509850	803465	10519	146
470880	800440	79053	142	496180	801990	79295	137	510770		72933	184
471320	803615	79067	172	496181	802010	79582	137	510780		72934	184
471600	802240	10714	150	496182		cs	138	512170	801965	79308	138

AYS CODE - AYS S-ABA CODE - PART NUMBER

AYS CODE	AYS S-ABA CODE	PART NUMBER	PAGE NO	AYS CODE	AYS S-ABA CODE	PART NUMBER	PAGE NO	AYS CODE	AYS S-ABA CODE	PART NUMBER	PAGE NO
512171	801955	79310	138	560520	802745	70919	174	578560	800620	79095	146
512180	801970	79309	138	560830		72895	116	578770		72921	146
512181	801960	79311	138	560840		72894	116	578780		72922	146
514850	802975	72817	180	560850	803380	79192	181	581080	801540	79007	139
515060		72877	149	560851	803515	79298	138	581090	801545	79008	139
515070		72878	150	560920		79101	168	581780	800010	cs	184
515850	801775	70720	144	560930		79102	168	581790	800005	cs	184
518520	803120	72143	169	561830		cs	184	581850	803365	79454	181
519040	802815	79569	184	561840		cs	184	581940		79366	146
519520	803170	70887	173	562660		79194	110	581950		79367	146
519521	803145	72115	158	562970		70866	174	582760	803690	cs	184
520530		72715	130	563160		70789	104	582780	800475	cs	184
520540		72716	130	563161		72506	110	582790	800480	cs	184
520940		70716	144	563162		79197	110	583040	802925	11011	147
520950		70717	144	563163		79221	110	583041	802915	72677	131
521040	800275	79564	184	563170		72507	110	583600	802090	10868	122
521530		72792	184	563171		79198	110	583610	802095	10869	122
521531		72943	184	563172		79222	111	583660		70519	104
521540		72791	184	563560		79694	111	583850	802990	72676	131
521541		72942	184	563570		79693	111	584260	800780	72327	122
521650		72722	130	563860	803595	79620	184	584780	800010	cs	184
521660		72721	130	563861	803735	72939	157	584790	800005	cs	184
523850	803010	10912	184	563862	803740	79133	157	584820		70518	104
526270	803820	cs	184	563940		79364	163	584821		70702	105
526520	803245	72698	170	563950		79365	163	584822		70950	105
527520	802905	70573	174	565520	802730	70891	155	584850	800255	72768	179
534860	803170	72255	173	565851	802725	70810	155	584850	800255	72858	179
536550	800585	72105	166	565852	803035	70903	169	585040	802840	72145	154
536560	800590	72106	166	566010	800965	72751	160	585520	802915	72363	154
538650		70786	166	566020	800970	72752	160	585620	801720	72320	184
538660		70785	167	566040	800275	72667	130	585621	801690	cs	184
544940		79122	180	566041	802845	79271	131	585630	801725	72321	184
546040	803255	70726	161	566260	800875	79202	111	585631	801695	cs	184
548950		79123	180	566690	801235	72707	184	586520		72354	105
549710		72028	147	566850	802995	72944	131	586530		72355	105
549720		72029	147	567851	802725	70809	155	587600	802060	72147	152
553550	800515	70572	130	567970		70852	124	587610	802065	72148	152
553560	800520	70571	130	568520	803555	70854	158	588940	801845	70870	105
553600	802400	79040	144	569180	802015	70899	138	588960		cs	184
553600	802400	79236	144	569200		70898	138	589300		79195	111
553610	802405	79041	144	569530		70855	138	589310		79196	111
553610	802405	79237	144	569540		70856	138	589950		cs	184
554040	802825	10911	184	569850	802985	72588	167	589960		cs	184
554940		72655	115	570760	803755	72861	184	590040	802785	72361	152
554950		72656	115	570780		72055	104	590041	802905	79062	184
555320	803710	72614	172	571170	801925	12363	161	590170	801975	79478	139
555321	803710	72888	170	571180	801930	12364	161	590180	801980	79479	139
555490		79167	122	571710		70943	167	591080	801530	79312	139
555500		79168	122	571720		70944	167	591081	801480	79650	163
556010	800925	72657	116	571950		72168	167	591090	801535	79313	139
556020	800930	72658	116	572970		79201	111	591091	801485	79651	163
557530		72374	144	574330		72192	167	593850	803445	70932	131
557540		72375	145	574340		72191	167	594020	803795	72157	181
557600	802470	72372	145	575040	802780	72405	167	594040		72772	160
557610	802475	72373	145	575041	802775	72406	167	595050		72773	160
557780	800335	cs	184	575042	802895	72407	167	599440	801710	70991	105
557790	800005	cs	184	575520	802780	72195	167	599450	801715	70990	105
558530		70869	147	577790		12311	162				
558540		70868	147	577800		12312	162				
558710		72747	116	578140		79431	139				
558711		72957	116	578150		79432	139				
558720		72746	116	578490		79105	116				
558721		72956	116	578500		79106	116				
558850	802990	72908	130	578520	803290	72326	178				
560041	803370	79103	184	578550	800615	79094	146				



ABA
Automatic Brake Adjuster / Otomatik Fren Ayar Kolu
S-ABA
(Self Setting) Automatic Brake Adjuster / Tam Otomatik Fren Ayar Kolu.

* CS > Customer Specific / Özel İmalat

PRODUCT PICTURES ARE TAKEN OF REFERENCE FOR CASTING BODIES. ALSO PLEASE IGNORE CONTROL UNIT & ITS POSITION. ÜRÜN FOTOĞRAFLARI GÖVDELER REFERANS ALINARAK YERLEŞTİRİLMİŞTİR. KİLİT VE KİLİT AÇILARINI DİKKATE ALMAYINIZ.

ALL ORIGINAL NUMBERS, MARKS AND MODELS FROM VEHICLE MANUFACTURERS LISTED IN THIS CATALOGUE ARE FOR COMPARISON PURPOSES ONLY AND MAY NOT BE USED IN INVOICES TO VEHICLE OWNERS OR RESELLERS. / ORJİNAL ÜRÜN NUMARALARI MÜŞTERİYİ BİLGİLENDİRME VE ÜRÜNE REFERANS AMAÇLI KULLANILMIŞTIR.

PART NUMBER - AYS CODE - AYS S-ABA CODE

PART NUMBER	AYS CODE	AYS S-ABA CODE	PAGE NO	PART NUMBER	AYS CODE	AYS S-ABA CODE	PAGE NO	PART NUMBER	AYS CODE	AYS S-ABA CODE	PAGE NO
10283	264010	801015	182	70626	334710		164	70880	313310		134
10284	264020	801020	182	70627	334720		164	70881	313320		134
10519	509850	803465	146	70634	360100	803095	165	70882	314520	803170	173
10714	471600	802240	150	70641	507600	802320	129	70883	314521	803215	173
10715	471610	802245	150	70642	507610	802325	129	70884	314970		172
10868	583600	802090	122	70643	338970		182	70886	314522	803125	173
10869	583610	802095	122	70660	342850	803040	165	70887	519520	803170	173
10911	554040	802825	184	70678	322520	803105	149	70891	565520	802730	155
10912	523850	803010	184	70678	322522	803105	149	70892	478860	803570	155
10937	357600	802040	153	70687	304520	803545	143	70893	327600	802060	151
10938	357610	802045	153	70702	584821		105	70894	327610	802065	151
10939	502042	802790	154	70706	250100	801560	98	70896	500180	802000	138
11011	583040	802925	147	70706	254780	801565	182	70897	500170	801995	138
12112	322600	802480	175	70708	353660		182	70898	569200		138
12113	322610	802485	175	70716	520940		144	70899	569180	802015	138
12132	431260	800885	157	70717	520950		144	70903	565852	803035	169
12141	326600	802100	182	70718	312600	802380	143	70905	500520	803000	145
12142	326610	802105	182	70719	312610	802385	143	70917	251400	801800	99
12194	411630		183	70720	515850	801775	144	70918	251300	801795	98
12195	411640		183	70726	546040	803255	161	70919	560520	802745	174
12206	474790		168	70752	437520	803110	179	70926	357010	801185	150
12207	474800		168	70753	283700	801720	101	70927	357020	801190	150
12243	508680	801440	184	70754	250400	801725	98	70928	357011	801180	150
12244	508690	801445	184	70759	378660		103	70930	327850	801765	152
12254	264600	802340	161	70762	430000	803315	174	70931	327860	801770	152
12255	264610	802345	161	70764	430100	803315	174	70932	593850	803445	131
12256	310800	803280	161	70768	322680	801310	149	70943	571710		167
12307	324521	803105	176	70771	290300		102	70944	571720		167
12310	448260	800880	162	70772	290200		101	70945	360200	803100	165
12311	577790		162	70775	250200	801850	98	70946	261500	802915	126
12312	577800		162	70785	538660		167	70949	359650		141
12313	436550	800635	161	70786	538650		166	70950	584822		105
12314	436560	800640	162	70787	342520	803195	165	70952	251600	800005	99
12350	326540		180	70789	563160		104	70953	251500	800010	99
12351	326530		180	70799	302521		150	70954	251800	801740	99
12356	415320	803705	161	70800	302511		150	70955	363800		102
12363	571170	801925	161	70802	322601	802300	140	70956	363810		102
12364	571180	801930	161	70803	322611	802305	140	70957	414850	803015	129
70510	305040	802770	164	70804	493520	803205	160	70959	491520	803560	158
70511	305600	802250	164	70805	371770	801735	102	70969	321400	801340	140
70512	305610	802255	164	70809	567851	802725	155	70970	321500	801345	140
70518	584820		104	70810	565851	802725	155	70975	313510		134
70519	583660		104	70823	319040	802915	120	70976	313520		134
70526	251560	800560	164	70824	241600	802090	118	70977	356600	802140	129
70527	251550	800555	164	70825	241700	802095	118	70978	356610	802145	129
70530	360000	803090	165	70832	261700	802600	126	70979	314523	803550	157
70532	325520	803175	164	70833	261710	802605	126	70980	338972		180
70542	302531		133	70838	357940		150	70986	368040	802900	154
70543	302541		133	70839	357950		150	70989	350100	803545	143
70544	302510		133	70840	335600	802210	164	70990	599450	801715	105
70545	302520		133	70841	335610	802215	165	70991	599440	801710	105
70571	553560	800520	130	70851	470040	802890	124	70992	373960	800005	102
70572	553550	800515	130	70852	567970		124	70993	373970	800010	102
70573	527520	802905	174	70854	568520	803555	158	70996	312970		146
70576	400100	803165	173	70855	569530		138	72007	371630		141
70582	325560	800570	164	70856	569540		138	72008	371640		141
70583	325550	800565	164	70859	260900	802905	151	72013	488790	800005	109
70608	303330		134	70865	338971		173	72014	312601	802370	143
70609	303340		134	70866	562970		174	72015	312611	802375	143
70615	498970		110	70867	382770	801735	103	72016	348260	800830	143
70619	306660		134	70868	558540		147	72017	350300	802670	143
70620	306650		134	70869	558530		147	72018	350400	802675	144
70621	316680	801470	134	70870	588940	801845	105	72019	357260	800720	165
70622	316690	801475	135	70871	240902	800750	117	72028	549710		147
70624	333220		164	70872	502940		122	72029	549720		147

PART NUMBER - AYS CODE - AYS S-ABA CODE

PART NUMBER	AYS CODE	AYS S-ABA CODE	PAGE NO	PART NUMBER	AYS CODE	AYS S-ABA CODE	PAGE NO	PART NUMBER	AYS CODE	AYS S-ABA CODE	PAGE NO
72030	314260	800795	147	72192	574330		167	72354	586520		105
72031	314524	803145	157	72195	575520	802780	167	72355	586530		105
72033	331510		155	72198	362260	800720	174	72356	376850	803285	174
72034	331520		155	72199	330400	800885	156	72357	380540		168
72035	332900		155	72203	210800		152	72358	380550		168
72036	484930	800030	104	72204	210900		153	72359	398860	803635	172
72037	484920	800025	104	72205	304850	803435	162	72361	590040	802785	152
72038	487040		104	72206	373170	802020	162	72362	502040	802840	154
72039	487050		104	72207	373180	802025	162	72363	585520	802915	154
72040	485100	800035	104	72208	283300	803425	108	72364	365040	802830	154
72041	485110	800040	104	72208	380520	803425	183	72367	502041	802915	154
72046	469240	801740	103	72211	377350		102	72370	364600	802390	144
72053	321300	803210	140	72212	377360		103	72371	364610	802395	144
72054	290103		101	72213	252000	801570	99	72372	557600	802470	145
72055	570780		104	72214	322850	803305	170	72373	557610	802475	145
72056	254400	802580	101	72215	360690	801395	170	72374	557530		144
72059	251900	802575	99	72216	360680	801390	170	72375	557540		145
72060	254500	802540	101	72217	360530		170	72376	339520	803500	143
72061	254600	802545	101	72218	360540		170	72385	474851	803275	178
72062	252200	800015	99	72234	253700	800015	100	72393	310040	802915	153
72063	252100	800020	99	72235	253600	800020	100	72401	391340		166
72064	369160		102	72238	366630		141	72402	391330		166
72065	369170		102	72239	366640		141	72403	391341		166
72069	254000	801825	101	72249	324524	803185	114	72404	391331		166
72070	254100	801830	101	72250	432320	800070	141	72405	575040	802780	167
72085	384040	802760	129	72251	326860	803725	159	72406	575041	802775	167
72086	342522	803195	165	72253	326320	800055	149	72407	575042	802895	167
72096	390220		103	72254	432862	800080	176	72408	310600	803320	147
72097	390230		103	72255	534860	803170	173	72416	490320	803775	144
72103	314525	803150	157	72256	468860	803170	173	72417	492600	802180	157
72104	505860	803760	158	72258	470863	800060	142	72418	492610	802185	157
72105	536550	800585	166	72259	326861	803765	172	72419	497520	802740	174
72106	536560	800590	166	72260	399860	803650	172	72420	494710		166
72114	357261	800735	174	72261	326862	800070	169	72421	494720		166
72115	519521	803145	158	72262	467860	803650	183	72422	495220		166
72120	391250		103	72263	320234	800055	148	72425	498040	800275	184
72121	391260		103	72265	468861	800070	183	72426	304710		143
72122	369161		102	72266	432860	800065	158	72427	304720		143
72128	369171		102	72267	326863	800075	157	72428	385850	802935	123
72137	357012	801035	135	72268	326864	803655	157	72429	386850	802935	123
72138	357021	801040	135	72269	470860	800080	142	72430	508610	802455	175
72140	327601	802210	152	72270	432861	800070	141	72431	508600	802450	175
72141	327611	802215	152	72271	326321	800055	140	72432	383710		165
72143	518520	803120	169	72272	326322	803780	182	72433	383720		165
72144	362520	803045	151	72273	326865	803770	182	72438	499040	803415	110
72145	585040	802840	154	72274	435800	800075	174	72439	385710		165
72147	587600	802060	152	72301	242900	801595	119	72440	385720		166
72148	587610	802065	152	72302	242800	801590	119	72441	386220		166
72149	361520	802900	179	72303	465850	801805	109	72446	497680	801420	180
72150	362600	802190	120	72304	465860	801810	109	72447	497690	801425	180
72151	362610	802195	120	72309	240800	800780	117	72448	301520	803200	147
72154	324523	803565	167	72310	242500	802595	119	72452	370000		152
72157	594020	803795	181	72311	242400	802590	119	72453	370100		152
72168	571950		167	72320	585620	801720	184	72457	327041	802905	155
72173	250900	801825	98	72321	585630	801725	184	72459	500530		145
72174	251000	801830	98	72322	466770	801735	109	72460	500540		145
72177	210905	801840	153	72326	578520	803290	178	72461	373530		145
72178	475490		103	72327	584260	800780	122	72462	373540		145
72179	354260	800725	156	72329	384850	803025	160	72506	563161		110
72180	330300	800885	156	72330	500851	803290	145	72507	563170		110
72181	357263	800895	156	72333	503040	800275	157	72508	464700	801630	109
72182	374261	800760	179	72334	322521	803155	140	72509	464710	801635	109
72189	311040	802755	151	72337	500470		110	72517	261600	802940	126
72190	311520	802765	151	72338	500460		110	72521	407850	801745	124
72191	574340		167	72344	358010	800935	182	72522	407860	801750	124



ABA
Automatic Brake Adjuster / Otomatik Fren Ayar Kolu.
S-ABA
(Self Setting) Automatic Brake Adjuster / Tam Otomatik Fren Ayar Kolu.

* CS > Customer Specific / Özel İmalat

PRODUCT PICTURES ARE TAKEN OF REFERENCE FOR CASTING BODIES. ALSO PLEASE IGNORE CONTROL UNIT & ITS POSITION. ÜRÜN FOTOĞRAFLARI GÖVDELER REFERANS ALINARAK YERLEŞTİRİLMİŞTİR. KİLİT VE KİLİT AÇILARINI DİKKATE ALMAYINIZ.

ALL ORIGINAL NUMBERS, MARKS AND MODELS FROM VEHICLE MANUFACTURERS LISTED IN THIS CATALOGUE ARE FOR COMPARISON PURPOSES ONLY AND MAY NOT BE USED IN INVOICES TO VEHICLE OWNERS OR RESELLERS / ORJİNAL ÜRÜN NUMARALARI MÜŞTERİYİ BİLGİLENDİRME VE ÜRİNE REFERANS AMAÇLI KULLANILMIŞTIR.

PART NUMBER - AYS CODE - AYS S-ABA CODE

PART NUMBER	AYS CODE	AYS S-ABA CODE	PAGE NO	PART NUMBER	AYS CODE	AYS S-ABA CODE	PAGE NO	PART NUMBER	AYS CODE	AYS S-ABA CODE	PAGE NO
72523	242001	802050	118	72618	309680	801350	170	72729	399840		115
72524	242101	802055	118	72633	236610	802445	133	72730	399830		115
72525	241800	802050	118	72634	236600	802440	133	72731	412630	801705	108
72526	241900	802055	118	72641	472850	803290	177	72732	412620	801700	108
72527	240200	801820	116	72643	369040	802900	175	72733	411320	803585	160
72529	241200	803420	117	72644	365041	802900	154	72742	422580		176
72530	240601	800755	117	72645	321200	803675	140	72743	422590		176
72531	243100	802930	119	72646	373680	801360	145	72744	231600	802665	112
72532	242000	802200	118	72647	380501	801365	145	72745	231500	802660	112
72533	242100	802205	118	72650	410960		108	72746	558720		116
72534	241100	802920	117	72651	410970		183	72747	558710		116
72535	243000	800755	119	72654	231100	803070	112	72750	497850	803310	184
72536	242300	802595	119	72655	554940		115	72751	566010	800965	160
72537	242200	802590	118	72656	554950		115	72752	566020	800970	160
72538	242600	801590	119	72657	556010	800925	116	72758	210200	803775	143
72539	242700	801595	119	72658	556020	800930	116	72759	378540		175
72540	240600	800785	117	72660	230300	801855	111	72760	378530		175
72541	241500	800780	118	72661	230400	801860	111	72763	322760	800055	140
72542	242301	802645	119	72662	230100	800790	111	72768	584850	800255	179
72543	242201	802640	118	72663	230800	801900	112	72772	594040		160
72544	240101	801755	116	72664	230700	801895	112	72773	595050		160
72545	240201	801760	117	72665	231700	801895	112	72777	504260	800730	160
72546	241201	802930	117	72666	231800	801900	112	72778	310100	800770	161
72547	240700	800780	117	72667	566040	800275	130	72779	405260	800730	183
72548	461650		122	72668	261400	802615	126	72782	260201	802525	125
72550	458040	802920	122	72669	261300	802610	125	72783	260101	802520	124
72551	455940		183	72670	261401	802625	126	72784	348390		129
72553	457852	803085	121	72671	261301	802620	125	72785	348380		128
72554	311500	803190	140	72672	302660		127	72788	508900	800060	173
72558	364260	800765	120	72673	302650		127	72791	521540		184
72559	245950		163	72674	302540		126	72792	521530		184
72560	245940		163	72675	302530		126	72794	455771		121
72563	343520	803100	165	72676	583850	802990	131	72795	455781		121
72566	480010	801170	168	72677	583041	802915	131	72802	420000	801400	171
72567	480020	801175	168	72678	261100	802880	125	72803	410002	801405	171
72568	362850	803045	156	72679	243300	802595	120	72804	409850	803300	171
72569	470861	803590	183	72680	243200	802590	120	72805	507611	802135	184
72570	398520	802970	179	72688	380000	800465	177	72806	507601	802130	184
72576	470862	803620	142	72689	380100	800470	177	72809	250800	801705	98
72578	489520	803425	184	72695	240300	801755	117	72810	250700	801700	98
72581	470863	800060	142	72696	240400	801760	117	72811	250600	801705	98
72583	270100	801080	176	72697	509520	803280	170	72812	250500	801700	98
72584	270200	801085	176	72698	526520	803245	170	72815	327602	802080	120
72585	270300	800860	176	72702	320900	800070	140	72816	327612	802085	120
72586	471601	802050	122	72703	320000	800055	148	72817	514850	802975	180
72587	471611	802055	122	72704	455770		121	72818	413010	800985	183
72588	569850	802985	167	72705	455780		121	72819	413020	800990	183
72591	385600	802350	144	72707	566690	801235	184	72820	414260	800825	183
72592	385610	802355	144	72710	492520	803210	142	72821	499680	801230	184
72593	253101	800015	100	72713	347660		128	72825	235400		113
72594	253000	800020	100	72714	347650		128	72826	235410		113
72596	251700	802575	99	72715	520530		130	72827	418260	800800	183
72597	501680		104	72716	520540		130	72828	410850	803295	171
72598	501690		104	72717	302661		127	72833	243400	801280	120
72599	312040	803535	134	72718	302651		127	72834	243500	801285	120
72600	359850	803540	135	72719	319540		128	72837	374260	800810	159
72601	312041	803530	134	72720	319530		128	72853	420970	800140	161
72602	459040		137	72721	521660		130	72854	484931	800505	178
72603	459050		137	72722	521650		130	72855	484921	800510	178
72604	259940		133	72723	260200	802495	125	72856	423010	801100	179
72608	455650		121	72724	260100	802490	124	72857	423020	801105	179
72609	455660		121	72725	260300	802840	125	72858	584850	800255	179
72614	555320	803710	172	72726	261200	802980	125	72861	570760	803755	184
72616	252800	800010	100	72727	390710		114	72862	425260	800805	174
72617	252900	800005	100	72728	390720		114	72863	470320	800070	141

PART NUMBER - AYS CODE - AYS S-ABA CODE

PART NUMBER	AYS CODE	AYS S-ABA CODE	PAGE NO	PART NUMBER	AYS CODE	AYS S-ABA CODE	PAGE NO	PART NUMBER	AYS CODE	AYS S-ABA CODE	PAGE NO
72864	330200	800895	156	72946	312690	801345	148	79066	322560	800540	177
72865	413520	803425	108	72947	230200	800815	147	79067	471320	803615	172
72867	420010	801150	168	72948	435300	800070	141	79068	485680	801210	124
72868	420020	801155	168	72949	232300	801855	113	79069	485690	801215	124
72869	414010	800975	159	72950	232400	801860	113	79071	506850	803045	184
72870	414020	800980	159	72951	232000	801900	113	79073	253200	800010	100
72871	310200	803580	146	72952	231900	801895	113	79074	253300	800005	100
72872	380300	802570	177	72953	353910	803070	114	79079	390000	800840	171
72875	320134	800055	148	72954	232100	801895	113	79080	393260	800915	172
72876	320234	800055	148	72955	232200	801900	113	79082	362521	803520	169
72877	515060		149	72956	558721		116	79086	503840		142
72878	515070		150	72957	558711		116	79087	503830		142
72879	312630		147	72958	367400		114	79088	313630		182
72880	312640		148	72959	367410		114	79089	414640		183
72881	312631		148	72962	353851	803075	114	79090	321100	803185	140
72882	312641		148	72963	353261	800790	114	79091	435900	803605	169
72883	360760	800060	149	72999	432970	800070	183	79092	362522	803505	169
72884	320500	801330	149	79002	436850	801825	124	79094	578550	800615	146
72885	320600	801335	149	79003	436860	801830	124	79095	578560	800620	146
72886	418770		120	79004	435800	800075	174	79097	437550	800595	173
72887	418780		120	79005	210000	800070	139	79098	437560	800610	173
72888	555321	803710	170	79006	210030	800070	139	79099	254200	801825	101
72892	405510	800460	115	79007	581080	801540	139	79100	254300	801830	101
72893	405500	800455	115	79008	581090	801545	139	79101	560920		168
72894	560840		116	79009	221300	801550	132	79102	560930		168
72895	560830		116	79010	221400	801555	133	79103	560041	803370	184
72896	419040	803250	175	79011	220500	803460	132	79105	578490		116
72897	304660		127	79012	220600	803455	132	79106	578500		116
72898	304650		127	79013	220100	801520	131	79107	312850	801785	171
72901	304651		127	79014	220200	801525	131	79108	312860	801790	171
72902	304661		127	79015	220301	801510	131	79109	400010	800070	172
72903	507850	803015	130	79016	220400	801515	131	79111	438700	803575	151
72904	507612	802220	129	79017	221000	802445	132	79112	438701	800070	169
72905	260400	802840	125	79018	220900	802440	132	79114	240970	803610	169
72906	302662		127	79019	473040	803455	137	79121	402850	803340	171
72907	302652		127	79020	221500	801520	133	79122	544940		180
72908	558850	802990	130	79021	221600	801525	133	79123	548950		180
72909	261000	803080	125	79022	435802	800065	158	79126	246600	801460	182
72910	231200	802855	112	79023	435803	800080	176	79127	246601	801465	182
72912	507602	802070	129	79024	435700		121	79132	392850	803425	103
72913	507851	803080	130	79025	435710		121	79133	563862	803740	157
72914	507603	802220	129	79028	437600	802310	175	79136	253500	800490	100
72915	312660		128	79029	437610	802315	175	79137	253400	800485	100
72916	312650		128	79030	312681	801310	147	79138	248010	800955	158
72917	322602	802100	172	79031	312691	801315	147	79139	248020	800960	158
72918	322612	802105	172	79035	435804	800070	141	79140	248940		182
72919	253800	801825	101	79038	503650		142	79141	248950		182
72920	253900	801830	101	79039	503660		142	79142	250601	802260	182
72921	578770		146	79040	553600	802400	144	79143	250610	802265	182
72922	578780		146	79041	553610	802405	144	79144	410000	801300	159
72928	264850	803345	171	79043	503600	802275	142	79145	250690	801305	159
72929	428400		177	79044	503610	802285	142	79146	248710		158
72930	380400	801380	177	79051	437860	803640	173	79147	248720		158
72931	480160		178	79052	470870	800435	142	79148	248970	803600	159
72932	480170		178	79053	470880	800440	142	79149	351700	800070	159
72933	510770		184	79055	326690	801315	182	79150	302560		133
72934	510780		184	79056	320400	803350	171	79151	302570		134
72935	444040	802885	183	79057	446530		163	79152	318530		135
72937	330000	801825	156	79058	446540		163	79153	318540		135
72938	330100	801830	156	79059	424810		163	79156	365600	802180	154
72939	563861	803735	157	79060	424820		163	79157	365610	802185	154
72942	521541		184	79062	590041	802905	184	79158	247600	802160	160
72943	521531		184	79063	374540		160	79159	247610	802165	160
72944	566850	802995	131	79064	374530		160	79160	361760	800070	129
72945	312680	801340	148	79065	322550	800535	177	79162	500880	800690	146



ABA
Automatic Brake Adjuster / Otomatik Fren Ayar Kolu.
S-ABA
(Self Setting) Automatic Brake Adjuster / Tam Otomatik Fren Ayar Kolu.

* CS > Customer Specific / Özel İmalat

PRODUCT PICTURES ARE TAKEN OF REFERENCE FOR CASTING BODIES. ALSO PLEASE IGNORE CONTROL UNIT & ITS POSITION. ÜRÜN FOTOĞRAFLARI GÖVDELER REFERANS ALINARAK YERLEŞTİRİLMİŞTİR. KİLİT VE KİLİT AÇILARINI DİKKATE ALMAYINIZ.

ALL ORIGINAL NUMBERS, MARKS AND MODELS FROM VEHICLE MANUFACTURERS LISTED IN THIS CATALOGUE ARE FOR COMPARISON PURPOSES ONLY AND MAY NOT BE USED IN INVOICES TO VEHICLE OWNERS OR RESELLERS / ORJINAL ÜRÜN NUMARALARI MÜŞTERİYİ BİLGİLENDİRME VE ÜRÜNE REFERANS AMAÇLI KULLANILMIŞTIR.

PART NUMBER - AYS CODE - AYS S-ABA CODE

PART NUMBER	AYS CODE	AYS S-ABA CODE	PAGE NO	PART NUMBER	AYS CODE	AYS S-ABA CODE	PAGE NO	PART NUMBER	AYS CODE	AYS S-ABA CODE	PAGE NO
79163	500870	800685	145	79251	375060		182	79359	306870	800675	127
79165	500881	800710	146	79255	272520	803405	182	79360	306880	800680	127
79166	500871	800705	146	79258	373600	802170	162	79364	563940		163
79167	555490		122	79259	373610	802175	162	79365	563950		163
79168	555500		122	79260	275770		162	79366	581940		146
79169	314526	802915	155	79261	275780		162	79367	581950		146
79170	492680	801200	154	79265	247540		151	79368	265660		114
79171	492690	801205	154	79266	247530		151	79369	265670		114
79177	508261	800900	170	79267	344040	800250	169	79371	423850	803290	121
79178	260800	803070	125	79268	344852	803525	181	79372	385851	802635	123
79179	242604	801580	119	79269	274680	800300	159	79393	508901	800070	184
79180	242705	801585	119	79270	274690	800295	158	79394	299170	801915	123
79181	364650		182	79271	566041	802845	131	79395	299180	801920	123
79182	364660		182	79272	351500		150	79396	436490		183
79183	361970	800060	172	79273	351501		150	79397	436500		183
79184	330500	800890	156	79274	269850	803510	182	79398	204790		123
79185	252300	802575	99	79282	287470		161	79399	204800		123
79186	303960		102	79283	287460		161	79402	264530		171
79192	560850	803380	181	79284	416321	800060	183	79403	264540		171
79193	474850	803425	109	79286	220105	801490	131	79404	202170	801945	182
79194	562660		110	79287	220203	801495	131	79404	202170	801945	182
79195	589300		111	79288	220800	802465	132	79405	202180	801950	182
79196	589310		111	79289	220700	802460	132	79407	203170	801935	122
79197	563162		110	79290	388170	802005	135	79408	203180	801940	122
79198	563171		110	79291	388180	802010	135	79412	206010	801090	182
79199	464150		109	79292	407170	802005	135	79413	206020	801095	182
79200	464140		108	79293	407180	802010	135	79414	296010	801090	182
79201	572970		111	79294	496170	801985	137	79415	296020	801095	182
79202	566260	800875	111	79295	496180	801990	137	79416	206850	800150	182
79203	281900		106	79296	433170	801985	136	79417	207060		182
79204	282000		107	79297	433180	801990	136	79418	207050		182
79205	282800	800010	107	79298	560851	803515	138	79428	367260	800740	129
79206	282900	800005	107	79299	220902	802430	132	79429	210804		177
79207	283300	803425	108	79300	221002	802435	132	79430	210902		177
79208	281500	801805	106	79301	416080	801490	136	79431	578140		139
79209	281600	801810	106	79302	416090	801495	136	79432	578150		139
79210	280900	801720	106	79303	221700	803470	133	79434	306010	800995	182
79211	281000	801725	106	79304	221100	802460	132	79435	306020	801000	182
79212	281400	801735	106	79305	221200	802465	132	79440	427170	801985	136
79213	500471		110	79306	427940	802440	136	79441	427180	801990	136
79214	500461		110	79307	427950	802445	136	79442	235830	801650	113
79215	282101	800875	107	79308	512170	801965	138	79443	235840	801655	113
79216	283100		107	79309	512180	801970	138	79444	250520	803180	179
79217	283000		107	79310	512171	801955	138	79453	401840		115
79218	283200	803415	108	79311	512181	801960	138	79454	581850	803365	181
79219	280800	801705	106	79312	591080	801530	139	79455	474680	801240	180
79220	280700	801700	106	79313	591090	801535	139	79456	474690	801245	180
79221	563163		110	79324	470863	800060	142	79459	508902	800060	184
79222	563172		111	79326	210000	800070	139	79461	276261	800905	155
79223	280300	801630	105	79327	320000	800055	148	79462	428400		177
79224	280400	801635	105	79330	435300	800070	141	79463	380400	801380	177
79225	282200		107	79331	210000	800070	139	79474	423170	801995	136
79226	282300		107	79332	210030	800070	139	79475	423180	802000	136
79227	489521	803425	109	79333	435804	800070	141	79476	447170	801975	137
79228	280600	801705	106	79343	267900	800070	139	79477	447180	801980	137
79229	280500	801700	105	79344	290601	801435	181	79478	590170	801975	139
79235	508900	800060	173	79345	290600	801430	181	79479	590180	801980	139
79236	553600	802400	144	79346	471760	803685	183	79491	353680	801410	169
79237	553610	802405	144	79347	233210		113	79492	353690	801415	170
79240	267900	800070	139	79348	233200		113	79493	481600	802330	169
79241	396920	800510	183	79349	330600	801885	156	79494	481610	802335	169
79242	396930	800505	183	79350	330700	801890	156	79499	434420	801610	176
79248	231000	801295	112	79351	461400		183	79500	434430	801615	176
79249	230900	801290	112	79352	461410		183	79501	378850	803065	123
79250	375050		182	79353	313260	800820	182	79503	357630		182

PART NUMBER - AYS CODE - AYS S-ABA CODE

PART NUMBER	AYS CODE	AYS S-ABA CODE	PAGE NO	PART NUMBER	AYS CODE	AYS S-ABA CODE	PAGE NO	PART NUMBER	AYS CODE	AYS S-ABA CODE	PAGE NO
79504	357640		182	79786	430830	801650	115	CS	435500		183
79510	310601	802410	175	79787	430840	801655	115	CS	435530		183
79511	310610	802415	175	CS	210400	802955	178	CS	435531		183
79514	465852	801805	109	CS	210500	802955	178	CS	435532		183
79515	465862	801810	109	CS	210700	800410	139	CS	435540		183
79520	246610	801450	182	CS	230500	801855	111	CS	435541		183
79521	246611	801455	182	CS	230600	801860	111	CS	435542		183
79535	220304	801500	131	CS	231300	801875	112	CS	435760	803685	141
79536	220403	801505	132	CS	231400	801880	112	CS	435761	803715	183
79542	451970	800070	159	CS	240500	800775	117	CS	435762	803585	183
79543	316520	803385	182	CS	241300	802960	118	CS	435763		158
79546	424220		179	CS	251100	801815	98	CS	435764		183
79547	424230		179	CS	251200	801820	98	CS	435971	800050	141
79550	432830	801640	115	CS	252400	801710	99	CS	453700		183
79551	432840	801645	115	CS	252500	801715	99	CS	453710		183
79552	210016	803670	182	CS	252600	801710	100	CS	454600	802550	183
79564	521040	800275	184	CS	252700	801715	100	CS	454610	802555	183
79567	312500	800655	182	CS	254780	801565	182	CS	457520	803355	181
79568	312510	800660	182	CS	255520	803330	182	CS	457522	803490	183
79569	519040	802815	184	CS	260600	802960	125	CS	457600	802500	183
79577	421490		121	CS	260700	802970	125	CS	457610	802505	183
79578	421500		121	CS	261800	802630	126	CS	461401		183
79581	496171	802005	137	CS	267520	800405	179	CS	461410		183
79582	496181	802010	137	CS	271600		176	CS	461411		183
79619	508701	803670	174	CS	271610		176	CS	465780	800485	103
79620	563860	803595	184	CS	273520	803360	180	CS	465790	800490	103
79625	401830		115	CS	276520	803335	182	CS	466600	802510	183
79628	479170	802005	137	CS	280100	801630	105	CS	466601	802530	183
79629	479180	802010	137	CS	280200	801635	105	CS	466610	802515	183
79630	435800	800075	174	CS	281100	801720	106	CS	466611	802535	183
79637	478420	801600	178	CS	281200	801725	106	CS	480850		184
79638	478430	801605	178	CS	281200	801725	106	CS	480851		184
79639	407680	801270	123	CS	281300	801735	106	CS	480860		184
79640	407690	801275	124	CS	282400		107	CS	480861		184
79641	311680	801320	128	CS	282500		107	CS	480861		184
79642	311690	801325	128	CS	282600		107	CS	480870		184
79643	385860	803645	123	CS	282700		107	CS	480871		184
79649	417701	800270	159	CS	283400	800870	108	CS	490520	803430	109
79650	591081	801480	163	CS	283500	800010	108	CS	496172		137
79651	591091	801485	163	CS	283600	800005	108	CS	496182		138
79658	429850	803030	181	CS	319760	800070	182	CS	509040		184
79662	204490		123	CS	320135	803695	148	CS	526270	803820	184
79663	204500		123	CS	320136	803695	148	CS	557780	800335	184
79677	281040	801865	126	CS	320137	800430	148	CS	557790	800005	184
79678	281050	801870	126	CS	320138		148	CS	561830		184
79682	357264	800910	156	CS	340000	802960	157	CS	561840		184
79683	473600	802420	184	CS	359770	801730	182	CS	581780	800010	184
79684	473610	802425	184	CS	360020	801835	162	CS	581790	800005	184
79691	335850	802700	182	CS	369780	800495	108	CS	582760	803690	184
79692	335870	802705	182	CS	369790	800500	108	CS	582780	800475	184
79693	563570		111	CS	370520	802975	182	CS	582790	800480	184
79694	563560		111	CS	376520	802965	182	CS	584780	800010	184
79695	413521	803425	183	CS	376521	802920	182	CS	584790	800005	184
79696	384850	803025	160	CS	376600	802530	182	CS	585621	801690	184
79697	507690	801225	130	CS	376610	802535	183	CS	585631	801695	184
79698	507680	801220	130	CS	389600	802460	135	CS	588960		184
79713	309870	800675	128	CS	389610	802465	135	CS	589950		184
79714	309880	800680	128	CS	390620	801680	114	CS	589960		184
79724	308260	800715	128	CS	390621	801685	114				
79725	442180	800020	183	CS	394000	802560	183				
79726	442190	800015	183	CS	416760	803700	183				
79727	438920		163	CS	416761		183				
79728	438930		163	CS	433171		136				
79763	475770		184	CS	433181		136				
79764	475780		184	CS	435370	801575	183				
				CS	435490		183				



ABA
Automatic Brake Adjuster / Otomatik Fren Ayar Kolu.
S-ABA
(Self Setting) Automatic Brake Adjuster / Tam Otomatik Fren Ayar Kolu.

* CS > Customer Specific / Özel İmalat

PRODUCT PICTURES ARE TAKEN OF REFERENCE FOR CASTING BODIES. ALSO PLEASE IGNORE CONTROL UNIT & ITS POSITION. ÜRÜN FOTOĞRAFLARI GÖVDELER REFERANS ALINARAK YERLEŞTİRİLMİŞTİR. KİLİT VE KİLİT AÇILARINI DİKKATE ALMAYINIZ.

ALL ORIGINAL NUMBERS, MARKS AND MODELS FROM VEHICLE MANUFACTURERS LISTED IN THIS CATALOGUE ARE FOR COMPARISON PURPOSES ONLY AND MAY NOT BE USED IN INVOICES TO VEHICLE OWNERS OR RESELLERS / ORJİNAL ÜRÜN NUMARALARI MÜŞTERİYİ BİLGİLENDİRME VE ÜRÜNE REFERANS AMAÇLI KULLANILMIŞTIR.

S-ABA / ABA Cross Reference List

S-ABA / ABA OEM Karşılaştırma Listesi



OEM NO	AYS S-ABA CODE	PAGE NO	AYS ABA CODE	PAGE NO	OEM NO	AYS S-ABA CODE	PAGE NO	AYS ABA CODE	PAGE NO	OEM NO	AYS S-ABA CODE	PAGE NO	AYS ABA CODE	PAGE NO
10274	802180	47	492600	157	14513	800060	64			14634	801990	37	496180	137
10275	802185	48	492610	157	14525	802920	28	241100	117	14645	800755	26	243000	119
10285	803245	82	526520	170	14526	802920	28	241100	117	14646	800755	26	243000	119
10315	803210	40	321300	140	14533	800070	39	210030	139	14651	802430	37	220902	132
10508	800030	18			14537	800790	23	230100	111	14652	802435	37	221002	132
10509	800025	18			14538	800790	23	230100	111	14685			313520	134
10516			290103	101	14539	801900	25	230800	112	14686			313510	134
10517			570780	104	14540	801895	25	230700	112	14687	802595	28	242300	119
10544			487050	104	14541			390710	114	14688	802590	28	242200	118
10545			487040	104	14542			390720	114	14693	801570	19	252000	99
10547			515070	150	14543	801520	35	220100	131	14694	801570	19	252000	99
10548			515060	149	14544	801525	35	220200	131	14695	801700	19	250700	98
10562	801330	44	320500	149	14545	800080	70			14696	801705	19	250800	98
10563	801335	44	320600	149	14549	803070	34	231100	112	14697	801560	19	250100	98
10643	800015	18			14550	803070	34	231100	112	14698	801560	19	250100	98
10644	800020	18			14553	802495	32	260200	125	14699			377360	103
10717	803165	51	400100	173	14554	802490	32	260100	124	14700			377350	102
10729	800055	44	326320	149	14555			521660	130	14701	801810	23	281600	106
10772	803650	30	399860	172	14556			521650	130	14702	801805	23	281500	106
10913	802400	41	553600	144	14557			554940	115	14703			282200	107
10914	802405	41	553610	144	14558			554950	115	14704			282300	107
10956	802390	41	364600	144	14559	800925	24	556010	116	14705			283000	107
10957	802395	41	364610	144	14560	800930	24	556020	116	14706			283100	107
10982			589300	111	14561			399840	115	14707	802575	21	251900	99
10983			589310	111	14562			399830	115	14708	802575	21	251900	99
10991	803190	40	311500	140	14563	802665	25	231600	112	14709	801845	20	588940	105
11899	800070	39	210000	139	14564	802660	25	231500	112	14710	801845	20	588940	105
12137			312630	147	14565	803460	38	220500	132	14711			572970	111
12138			312640	148	14566	803460	38	220500	132	14712			572970	111
12159	800465	70	380000	177	14567	803455	38	473040	137	14713	801735	20	281400	106
12160	800470	70	380100	177	14568	803455	38	220600	132	14714	801735	20	281400	106
12185	802260	67	250601	182	14569	802055	27	242101	118	14715	802545	21	254600	101
12186	802265	67	250610	182	14570	802050	27	242001	118	14716	802540	20	254500	101
12187	801300	66	410000	159	14571	802525	32	260201	125	14717	800015	18		
12188	801305	67	250690	159	14572	802520	32	260101	124	14718	800020	18		
12192			312631	148	14573	802845	33	566041	131	14719	803425	23	489521	109
12193			312641	148	14574	802845	33	566041	131	14720	803425	23	489521	109
12198			446530	163	14575			304661	127	14721	801720	20	280900	106
12199			446540	163	14576			304651	127	14722	801725	20	281000	106
12204			424810	163	14581	801855	24	230300	111	14723	800875	22	282101	107
12205			424820	163	14582	801860	24	230400	111	14724	800875	22	282101	107
12212	800060	64	360760	149	14583	801655	24	235840	113	14725	803425	23	283300	108
12226	803710	63	555321	170	14584	801650	24	235830	113	14726	803425	23	283300	108
12234	803580	43	310200	146	14585	800815	24	230200	147	14727	801820	27	240200	116
12235	800140	72	420970	161	14586	800815	24	230200	147	14729	801285	26	243500	120
12242	803250	68	419040	175	14587	802855	25	231200	112	14730	801280	26	243400	120
12257			480160	178	14588	802855	25	231200	112	14735			290300	102
12258			480170	178	14589			348390	129	14736			290200	101
12277			428400	177	14590			348380	128	14739	802465	38	221200	132
12278	801380	70	380400	177	14593	800465	70	380000	177	14740	802460	38	221100	132
12279	803345	63	264850	171	14594	800470	70	380100	177	14755	801850	20	250200	98
12285	801985	36	427170	136	14607	801525	35	220200	131	14756	801850	20	250200	98
12286	801990	37	427180	136	14608	801520	35	220100	131	14763			435700	121
12326	803350	63	320400	171	14611			558710	116	14764			435710	121
12335	800010	18			14612			558720	116	14765	801760	27	240400	117
12336	800005	18			14615			318530	135	14766	801755	26	240300	117
12344			248710	158	14616			318540	135	14767			461650	122
12345			248720	158	14617			302560	133	14768			461650	122
12348	800595	64	437550	173	14618			302570	134	14769	803420	29	241200	117
12349	800610	64	437560	173	14619	803470	38	221700	133	14770	803420	29	241200	117
12630	800065	51	435802	158	14620	803470	38	221700	133	14771			455771	121
14031	801775	78	515850	144	14621	803515	38	560851	138	14772			455781	121
14032	801775	78	515850	144	14622	803515	38	560851	138	14773			584820	104
14271	800080	70	435803	176	14629	801490	35	416080	136	14774			584820	104
14503	800055	44			14630	801495	35	416090	136	14779			584822	105
14505	800070	39			14631	801970	36	512180	138	14780			584822	105
14507	800075	68			14632	801965	36	512170	138	14781			455660	121
14511	800060	64			14633	801985	36	496170	137	14782			455650	121

S-ABA / ABA Cross Reference List

S-ABA / ABA OEM Karşılaştırma Listesi

OEM NO	AYS S-ABA CODE	PAGE NO	AYS ABA CODE	PAGE NO	OEM NO	AYS S-ABA CODE	PAGE NO	AYS ABA CODE	PAGE NO	OEM NO	AYS S-ABA CODE	PAGE NO	AYS ABA CODE	PAGE NO
14791	801035	34	357012	135	70740	802840	33	260400	125	70974	803070	34	231100	112
14792	801040	35	357021	135	70760	800005	18			70981			578140	139
14809			455770	121	70761	800010	18			70982			578150	139
14810			455780	121	70765	803080	34	507851	130	70983	800070	39	435300	141
14813	801545	36	581090	139	70770			562660	110	70984	800060	64	470863	142
14814	801540	36	581080	139	70781	802220	32	507612	129	70985	803080	34	261000	125
14815	802465	38	220800	132	70782	802220	32	507603	129	72001	801895	25	231700	112
14816	802460	38	220700	132	70801	800815	24	230200	147	72002	801900	25	231800	112
14817	801990	37	427180	136	70804	800080	70	435803	176	72005	801540	36	581080	139
14818	801985	36	427170	136	70807			563163	110	72006	801545	36	581090	139
14819	800785	26	240600	117	70808			563172	111	72009	802855	25	231200	112
14820	800785	26	240600	117	70818	800055	44	326320	149	72010	800055	44	320234	148
14821	801510	35	220301	131	70834	802620	33	261301	125	72012	800010	18	282800	107
14822	801515	35	220400	131	70835	802625	33	261401	126	72013	800005	18	282900	107
14823	800800	39	418260	183	70846	800875	22	566260	111	72021	802840	33	260300	125
16103	802300	39	322601	140	70847			282200	107	72022			302660	127
16104	802305	39	322611	140	70848			282300	107	72023			302650	127
16879	800060	64	508900	173	70849			319540	128	72024			302540	126
27161	800060	64	508902	184	70850			319530	128	72025			302530	126
27297	802010	37	407180	135	70857	800875	22	282101	107	72026	802990	34	583850	131
30155	800060	64	508900	173	70864	800790	23	230100	111	72027	802915	28	583041	131
36300	800070	39	210000	139	70874	803725	67	326860	159	72036	800030	18		
40068	800060	64	508900	173	70877	800070	39	435300	141	72037	800025	18		
40232	800070	39	508901	184	70878	801855	24	230300	111	72040	800035	18		
52305	802305	39	322611	140	70879	801860	24	230400	111	72041	800040	18		
52306	802300	39	322601	140	70882	803170	64	468860	173	72057	800080	70	435803	176
70618	800055	44	326320	149	70887	803170	64	534860	173	72062	800015	18		
70635			347660	128	70888			572970	111	72063	800020	18		
70636			347650	128	70900			521660	130	72066	800080	70	435803	176
70639			520530	130	70901			521650	130	72071	803775	42	490320	144
70640			520540	130	70902	800275	68	566040	130	72089	801550	36	221300	132
70646	802135	32	507611	184	70907			282300	107	72090	801555	36	221400	133
70647	802130	32	507601	184	70908			282200	107	72091			233200	113
70649	802070	31	507602	129	70909	802495	32	260200	125	72092			233210	113
70661	803070	34	231100	112	70910	802490	32	260100	124	72093			281900	106
70662	802665	25	231600	112	70911			563171	110	72094			282000	107
70663	802660	25	231500	112	70912			563162	110	72095	803650	30	399860	172
70664			578500	116	70913			302662	127	72099	803460	38	220500	132
70665			578490	116	70914			302652	127	72100	803455	38	220600	132
70666			554940	115	70915			312660	128	72107	802050	27	242001	118
70667			554950	115	70916			312650	128	72108	802055	27	242101	118
70668	800925	24	556010	116	70920	803070	34	260800	125	72109	802050	27	241800	118
70669	800930	24	556020	116	70921	802615	33	261400	126	72110	802055	27	241900	118
70670			558720	116	70922	802610	33	261300	125	72111	801820	27	240200	116
70671			558710	116	70923	802625	33	261401	126	72116	803420	29	241200	117
70672	802610	33	261300	125	70924	802620	33	261301	125	72117	800755	26	240601	117
70673	802615	33	261400	126	70937	801900	25	230800	112	72119	803170	64	534860	173
70695			464140	108	70938	801895	25	230700	112	72122			521541	184
70696			464150	109	70941	802990	34	558850	130	72123			521531	184
70698	800070	39	435300	141	70947	801825	20	250900	98	72124			521540	184
70703	803015	34	507850	130	70948	801830	20	251000	98	72125			521530	184
70704	801225	31	507690	130	70951			584822	105	72126	802995	34	566850	131
70705	801220	31	507680	130	70952	800005	18			72127			369160	102
70707	803425	23	474850	109	70953	800010	18			72139	802930	28	243100	119
70709	800055	44	326320	149	70958	803415	23	283200	108	72144	803045	47	362850	156
70710			302560	133	70959	800065	51	435802	158	72152	802525	32	260201	125
70711			302570	134	70960			366630	141	72153	802520	32	260101	124
70712			318530	135	70961			366640	141	72158			283000	107
70713			318540	135	70962			282200	107	72159			283100	107
70722	801720	20	280900	106	70963			282300	107	72160	801520	35	220100	131
70723	801725	20	281000	106	70964	801630	22	280300	105	72161	801525	35	220200	131
70724			302661	127	70965	801635	22	280400	105	72162	801510	35	220301	131
70725			302651	127	70966	801850	20	250200	98	72163	801515	35	220400	131
70730	801630	22	280300	105	70967			290300	102	72164	802200	27	242000	118
70731	801635	22	280400	105	70968			290200	101	72165	802205	28	242100	118
70734	801735	20	281400	106	70971	803775	42	210200	143	72166	802880	33	261100	125
70738			304651	127	70972			401840	115	72167	802980	34	261200	125
70739			304661	127	70973			560830	116	72170			461650	122



Automatic Brake Adjuster / Otomatik Fren Ayar Kolu.
S-ABA
(Self Setting) Automatic Brake Adjuster / Tam Otomatik Fren Ayar Kolu.

* CS > Customer Specific / Özel İmalat

ALL ORIGINAL NUMBERS, MARKS AND MODELS FROM VEHICLE MANUFACTURERS LISTED IN THIS CATALOGUE ARE FOR COMPARISON PURPOSES ONLY AND MAY NOT BE USED IN INVOICES TO VEHICLE OWNERS OR RESELLERS / ORJINAL ÜRÜN NUMARALARI MÜŞTERİYİ BİLGİLENDİRME VE ÜRÜNE REFERANS AMAÇLI KULLANILMIŞTIR.

S-ABA / ABA Cross Reference List

S-ABA / ABA OEM Karşılaştırma Listesi



OEM NO	AYS S-ABA CODE	PAGE NO	AYS ABA CODE	PAGE NO	OEM NO	AYS S-ABA CODE	PAGE NO	AYS ABA CODE	PAGE NO	OEM NO	AYS S-ABA CODE	PAGE NO	AYS ABA CODE	PAGE NO
72193			391341	166	72394	802005	37	479170	137	72630			235400	113
72194			391331	166	72395	802010	37	479180	137	72631			235410	113
72195	802780	58	575040	167	72414	800010	18	282800	107	72632	803070	34	231100	112
72196	802775	58	575041	167	72415	800005	18	282900	107	72659			558710	116
72197	802920	28	241100	117	72434			283100	107	72690			265660	114
72202	800755	26	243000	119	72435			283000	107	72691			265670	114
72208	803425	23	283300	108	72436			455940	183	72702	800070	39	210000	139
72210	803415	23	283200	108	72438	803415	23	283200	108	72703	800055	44	320134	148
72223	802595	28	242300	119	72442	803085	28	457852	121	72731	801705	19	280600	106
72224	802590	28	242200	118	72444	801400	54	420000	171	72732	801700	19	280500	105
72232			348390	129	72445	801405	54	410002	171	72738	801490	35	220105	131
72233			348380	128	72455	801705	19	280800	106	72739	801495	35	220203	131
72234	800015	18			72456	801700	19	280700	106	72740	802465	38	220800	132
72235	800020	18			72464	803070	34	231100	112	72741	802460	38	220700	132
72236			401840	115	72467	800790	23	230100	111	72750	803295	54	410850	171
72237			390710	114	72468	800455	23	405500	115	72763	800055	44	320234	148
72246	802845	33	566041	131	72469	800460	23	405510	115	72770	802005	37	496171	137
72247			235400	113	72474			233200	113	72771	802010	37	496181	137
72248			235410	113	72475			233210	113	72786	802005	37	388170	135
72250	800070	39	435300	141	72476	801895	25	231700	112	72787	802010	37	388180	135
72252	803775	42	210200	143	72477	801900	25	231800	112	72796	802005	37	407170	135
72254	800080	70	435803	176	72478			399840	115	72797	802010	37	407180	135
72258	800060	64	470863	142	72479			399830	115	72798	801985	36	496170	137
72263	800055	44	320234	148	72482			401840	115	72799	801990	37	496180	137
72266	800065	51	435802	158	72483			390710	114	72807			578490	116
72270	800070	39	210030	139	72484			401840	115	72808			578500	116
72271	800055	44	320234	148	72485			560830	116	72813	801985	36	433170	136
72274	800075	68	435800	174	72486	801900	25	230800	112	72814	801990	37	433180	136
72301	801595	26	242700	119	72487	801895	25	230700	112	72824	803515	38	560851	138
72302	801590	26	242600	119	72488			235400	113	72829	801420	54	497680	180
72303	801805	23	281500	106	72489			235410	113	72830	801425	54	497690	180
72304	801810	23	281600	106	72490	803070	34	231100	112	72831	803320	49	310600	147
72305	800785	26	240600	117	72491	801855	24	230300	111	72835	802430	37	220902	132
72308	801735	20	382770	103	72492	801860	24	230400	111	72836	802435	37	221002	132
72309	800780	26	241500	118	72500			282200	107	72838	801490	35	416080	136
72310	802645	28	242301	119	72501			282300	107	72839	801495	35	416090	136
72311	802640	28	242201	118	72502			563162	110	72840	803470	38	221700	133
72312	801755	26	240101	116	72503			563171	110	72851	801650	24	430830	115
72313	801760	27	240201	117	72504			464150	109	72852	801655	24	430840	115
72314	802930	28	241201	117	72505			464140	108	72865	803425	23	413521	183
72315	803300	38	409850	171	72506			563163	110	72891			233200	113
72318	802445	37	221000	132	72507			563172	111	72949	801855	24	230300	111
72319	802440	37	220900	132	72508	801630	22	280300	105	72950	801860	24	230400	111
72320	801720	20	280900	106	72509	801635	22	280400	105	72951	801900	25	230800	112
72321	801725	20	281000	106	72512			282200	107	72952	801895	25	230700	112
72322	801735	20	281400	106	72513			282300	107	72953	803070	34	231100	112
72327	800780	26	240700	117	72514			572970	111	72954	801895	25	231700	112
72328	803455	38	473040	137	72515	800875	22	566260	111	72955	801900	25	231800	112
72329	803025	52	384850	160	72561			281900	106	72956			390720	114
72337			500471	110	72562			282000	107	72957			390710	114
72338			500461	110	72576	800070	39	210000	139	72958			235400	113
72339			589300	111	72578	803425	23	489521	109	72959			235410	113
72340			589310	111	72579			390710	114	72960			399840	115
72342			461650	122	72580			390720	114	72961			399830	115
72346	801520	35	221500	133	72593	800015	18			72962	803070	34	231100	112
72347	801525	35	221600	133	72594	800020	18			72963	800790	23	230100	111
72348	800875	22	282101	107	72616	800010	18			72965	800010	18	282800	107
72349	800455	23	405500	115	72617	800005	18			72966	800005	18	282900	107
72350	800460	23	405510	115	72620	801900	25	230800	112	72967	803425	23	283300	108
72351			282200	107	72621	801895	25	230700	112	72968	801805	23	281500	106
72352			282300	107	72622	800790	23	230100	111	72969	801810	23	281600	106
72368	802400	41	553600	144	72623	803070	34	231100	112	72970	801720	20	280900	106
72369	802405	41	553610	144	72624	801855	24	230300	111	72971	801725	20	281000	106
72378			563570	111	72625	801860	24	230400	111	72972	801735	20	281400	106
72383	800765	26	364260	120	72626	801900	25	231800	112	72973			500471	110
72384	802920	28	458040	122	72627	801895	25	231700	112	72974			500461	110
72388			399840	115	72628			233210	113	72975	800875	22	282101	107
72389			399830	115	72629			233200	113	72977			563570	111

S-ABA / ABA Cross Reference List

S-ABA / ABA OEM Karşılaştırma Listesi

OEM NO	AYS S-ABA CODE	PAGE NO	AYS ABA CODE	PAGE NO	OEM NO	AYS S-ABA CODE	PAGE NO	AYS ABA CODE	PAGE NO	OEM NO	AYS S-ABA CODE	PAGE NO	AYS ABA CODE	PAGE NO
72978			283100	107	79332	800070	39	210030	139	281091	802055	27	241900	118
72979			283000	107	79333	800070	39	435804	141	281094	802930	28	243100	119
72980	803415	23	283200	108	79334			503650	142	281095	802930	28	243100	119
72981	801705	19	280800	106	79335			503660	142	282609	802920	28	241100	117
72982	801700	19	280700	106	79336	802275	79	503600	142	282610	802920	28	241100	117
72983			563163	110	79337	802285	39	503610	142	284860	800755	26	243000	119
72984			563172	111	79338	800435	39	470870	142	289691	802595	28	242300	119
72985	801630	22	280300	105	79339	800440	39	470880	142	289692	802590	28	242200	118
72986	801635	22	280400	105	79340			503840	142	292924	802200	27	242000	118
72987			282200	107	79341			503830	142	292925	802205	28	242100	118
72988			282300	107	79342	803185	25	321100	140	297172	801760	27	240201	117
72989	803425	23	489521	109	79343	800070	39	267900	139	297173	801755	26	240101	116
72990	801705	19	280600	106	79464	800715	31	308260	128	297174	802930	28	241201	117
72991	801700	19	280500	105	79465	802420	37	473600	184	297175	802930	28	241201	117
72992	803425	23	413521	183	79466	802425	37	473610	184	308677	803070	34	231100	112
72993	801985	36	427170	136	79497	800675	31	309870	128	309423			401840	115
72994	801990	37	427180	136	79498	800680	31	309880	128	309424			560830	116
72995	801640	24	432830	115	79502	803210	40	321300	140	311508	802855	25	231200	112
72996	801645	24	432840	115	79514	801805	23	281500	106	321469	801900	25	231800	112
72997	802460	38	221100	132	79515	801810	23	281600	106	321470	801895	25	231700	112
72998	802465	38	221200	132	79552	803670	43	508701	174	337389			233210	113
74585	800885	49	330300	156	79572	800020	18	442180	183	337390			233200	113
77909	800915	64	393260	172	79573	800015	18	442190	183	361323	800785	26	240600	117
79000	802440	37	427940	136	79631	800070	39	210030	139	361540	800780	26	241500	118
79001	802445	37	427950	136	79735	803025	52	384850	160	361541	802645	28	242301	119
79033	801650	24	235830	113	80018	800135	39			361542	802640	28	242201	118
79034	801655	24	235840	113	80084	800360	21			361543	801595	26	242700	119
79045	801995	37	423170	136	80085	800365	21			361544	801590	26	242600	119
79046	802000	37	423180	136	80086	800390	22			362046			401840	115
79047	801975	36	447170	137	80087	800370	21			362047			390710	114
79048	801980	36	447180	137	80088	800375	22			362134			235410	113
79049	801975	36	590170	139	80092	800380	22			362135			235400	113
79050	801980	36	590180	139	80093	800385	22			374800	800780	26	240700	117
79072	800275	68	521040	184	86992	800070	39	210000	139	374801	800780	26	240700	117
79073	800010	18			119506	803100	59	360200	165	380253	800460	23	405510	115
79074	800005	18			159570	802930	28	241201	117	380254	800455	23	405500	115
79075	801965	36	512170	138	159579	803085	28	457852	121	383825			399830	115
79076	801970	36	512180	138	178529	803035	45	565852	169	383826			399840	115
79077	801955	36	512171	138	178529	803035	45	565852	169	384417	801900	25	230800	112
79078	801960	36	512181	138	209923	803615	64	471320	172	384418	801895	25	230700	112
79124	801530	35	591080	139	215850	803070	34	231100	112	384419	800790	23	230100	111
79125	801535	36	591090	139	218833	802665	25	231600	112	388947	803085	28	457852	121
79161	800740	31	367260	129	218834	802660	25	231500	112	390065			461650	122
79190	801320	31	311680	128	219859			578500	116	392736	800765	26	364260	120
79191	801325	31	311690	128	219860			578490	116	392737	802920	28	458040	122
79235	800060	64	508900	173	219997			554940	115	392738	802920	28	458040	122
79256	801500	35	220304	131	219998			554950	115	394180	803070	34	231100	112
79257	801505	35	220403	132	221733	800925	24	556010	116	394181	801855	24	230300	111
79275	801865	31	281040	126	221734	800930	24	556020	116	394182	801860	24	230400	111
79276	801870	31	281050	126	221737			558720	116	394183			401840	115
79314			359650	141	221738			558710	116	394184			560830	116
79315	801340	39	321400	140	223333			455940	183	394185	801900	25	231800	112
79316	801345	39	321500	140	246392	800815	24	230200	147	394186	801895	25	231700	112
79317			371630	141	253855	803290	28	500851	145	394187			233210	113
79318			371640	141	276525	801900	25	230800	112	394188			233200	113
79319			366630	141	276526	801895	25	230700	112	394189			390710	114
79320			366640	141	276576	801895	25	230700	112	394190			401840	115
79321	800070	39	435300	141	278350	802050	27	242001	118	394191			235400	113
79322	800070	39	210030	139	278351	802055	27	242101	118	394192			235410	113
79323	803620		470862	142	278678	800755	26	240601	117	394193	800460	23	405510	115
79323	800070	39	210000	139	278679	800755	26	240601	117	394194	800455	23	405500	115
79324	800060	64	470863	142	278737	801855	24	230300	111	394195			399840	115
79325	803675	40	321200	140	278738	801860	24	230400	111	394196			399830	115
79326	800070	39	210000	139	278739	800790	23	230100	111	394197	803070	34	231100	112
79328	803210	40	492520	142	279234	801820	27	240200	116	394419	800790	23	230100	111
79329	800800	39	418260	183	279243	803420	29	241200	117	394783			401840	115
79330	800070	39	435300	141	279244	803420	29	241200	117	397745			390710	114
79331	800070	39	210000	139	281090	802050	27	241800	118	397746			390720	114



ABA
Automatic Brake Adjuster / Otomatik Fren Ayar Kolu.
S-ABA
(Self Setting) Automatic Brake Adjuster / Tam Otomatik Fren Ayar Kolu.

ALL ORIGINAL NUMBERS, MARKS AND MODELS FROM VEHICLE MANUFACTURERS LISTED IN THIS CATALOGUE ARE FOR COMPARISON PURPOSES ONLY AND MAY NOT BE USED IN INVOICES TO VEHICLE OWNERS OR RESELLERS / ORJINAL ÜRÜN NUMARALARI MÜŞTERİYİ BİLGİLENDİRME VE ÜRÜNE REFERANS AMAÇLI KULLANILMIŞTIR.

* CS > Customer Specific / Özel İmalat

S-ABA / ABA Cross Reference List

S-ABA / ABA OEM Karşılaştırma Listesi



OEM NO	AYS S-ABA CODE	PAGE NO	AYS ABA CODE	PAGE NO	OEM NO	AYS S-ABA CODE	PAGE NO	AYS ABA CODE	PAGE NO	OEM NO	AYS S-ABA CODE	PAGE NO	AYS ABA CODE	PAGE NO
412003			326540	180	1112833	801855	24	230300	111	1358634	801650	24	235830	113
412004			326530	180	1112834	801860	24	230400	111	1358635	801655	24	235840	113
412006	800070	39	438701	169	1112835	801900	25	231800	112	1372187			421490	121
436220	800435	39	470870	142	1112836	801895	25	231700	112	1372188			421500	121
436225	800440	39	470880	142	1112837			233210	113	1387718	800065	51	435802	158
537146	803655	51	326864	157	1112838			233200	113	1452423	801745	29	407850	124
537537	800765	26	364260	120	1112839			235400	113	1571482	801220	31	507680	130
537539	802920	28	241100	117	1112840			235410	113	1581466	802840	33	260400	125
611484	802905	48	260900	151	1112841	803070	34	231100	112	1581471			304661	127
611485	802900	44	368040	154	1134293			302661	127	1581472			304651	127
612051	802840	33	585040	154	1134294			302651	127	1581476	802070	31	507602	129
626343	800465	70	380000	177	1134295			520530	130	1581478	802325	32	507610	129
626344	800470	70	380100	177	1134296			520540	130	1581479	802320	32	507600	129
627180	803345	63	264850	171	1134297			347660	128	1581480	803015	34	507850	130
633615	803350	63	320400	171	1134298			347650	128	1581481	801225	31	507690	130
636318	800840	63	390000	171	1134451			319540	128	1581482	801220	31	507680	130
651623	802830	48	365040	154	1134452			319530	128	1581483	802135	32	507611	184
651624	802040	47	357600	153	1134829			521660	130	1581484	802130	32	507601	184
651625	802045	47	357610	153	1134830			521650	130	1581485	802615	33	261400	126
651626	802840	33	502040	154	1135004	800275	68	566040	130	1581486	802610	33	261300	125
651630	802790	48	502042	154	1135394			302662	127	1581487	803080	34	507851	130
651630	802790	48	502042	154	1135395			302652	127	1581490	802220	32	507612	129
651777	802915	28	502041	154	1136430			312660	128	1581491	802220	32	507603	129
651852	802900	44	368040	154	1136431			312650	128	1581492	802625	33	261401	126
652568	802840	33	502040	154	1136432	802495	32	260200	125	1581493	802620	33	261301	125
652626	802840	33	502040	154	1136433	802490	32	260100	124	1581800	802990	34	558850	130
654172	803340	63	402850	171	1137064			428400	177	1586190	802615	33	261400	126
699433			264540	171	1137065	801380	70	380400	177	1586191	802610	33	261300	125
699434			264530	171	1195314			521540	184	1586192	802625	33	261401	126
718984	803305	62	322850	170	1195315			521530	184	1586193	802620	33	261301	125
730105	800070	39	435300	141	1195316	802995	34	566850	131	1586194	803070	34	260800	125
730109	801235	77	566690	184	1195321			521541	184	1587482	802915	28	261500	126
730121	803170	64	468860	173	1195322			521531	184	1590239	803080	34	261000	125
819136	800250	39	344040	169	1195461	802525	32	260201	125	1592871			302660	127
819137	803525	64	344852	181	1195462	802520	32	260101	124	1592872			302650	127
843684	800560	57	251560	164	1196321	802880	33	261100	125	1592873			302540	126
843685	803090	58	360000	165	1196322	802980	34	261200	125	1592874			302530	126
863101	803175	59	325520	164	1197965			348390	129	1592875	802840	33	260300	125
866101	803175	59	325520	164	1197966			348380	128	1592876	802990	34	583850	131
885373	800070	39	326862	169	1227274	800755	26	240601	117	1592877	802915	28	583041	131
885374	800055	44	320134	148	1234403			455771	121	1644815	803460	38	220500	132
914244	801390	54	360680	170	1234404			455781	121	1662200	800015	18		
914245	801395	54	360690	170	1242589	801285	26	243500	120	1662201	800020	18		
914248			360530	170	1242597	801280	26	243400	120	1666003	802625	33	261401	126
914249			360540	170	1242598	801285	26	243500	120	1666004	802620	33	261301	125
914264	803300	38	409850	171	1263485			418770	120	1666050			302660	127
914265	803320	49	310600	147	1263486			418780	120	1666051			302650	127
914266	803285	67	376850	174	1267842	802920	28	458040	122	1789560	800790	23	230100	111
914268	803295	54	410850	171	1267843	802920	28	458040	122	1789561	801855	24	230300	111
915284	801400	54	420000	171	1282111			435700	121	1789562	801860	24	230400	111
915285	801405	54	410002	171	1282112			435710	121	1789563			233210	113
915286	801420	54	497680	180	1309074	801580	26	242604	119	1789564			233200	113
915287	801425	54	497690	180	1309075	801585	26	242705	119	1789567	801650	24	235830	113
917980	801400	54	420000	171	1311809			555490	122	1789568	801655	24	235840	113
917981	801405	54	410002	171	1311810			555500	122	1789571			390710	114
917982	803300	38	409850	171	1316287			364650	182	1789572			390720	114
917983	801350	62	309680	170	1316288			364660	182	1944551	802005	37	496171	137
917985	803295	54	410850	171	1324357			578490	116	1944552	802010	37	496181	137
1004000	801630	22	280300	105	1324358			578500	116	2321243	801380	70	380400	177
1004001			282300	107	1325309	800055	44	320134	148	2700054	800890	49	330500	156
1042976	800275	68	498040	184	1325310	800070	39	210000	139	3013676	802845	33	566041	131
1042982	802915	28	310040	153	1325311			359650	141	3136246	801320	31	311680	128
1108061			265660	114	1325312	800080	70	435803	176	3136247	801325	31	311690	128
1108062			265670	114	1325313	800060	64	508900	173	3136426	801320	31	311680	128
1112829	801900	25	230800	112	1335985	801655	24	430840	115	3136427	801325	31	311690	128
1112830	801895	25	230700	112	1335986	801650	24	430830	115	3177014	800715	31	308260	128
1112831	800790	23	230100	111	1356695	801645	24	432840	115	3177673	803290	28	500851	145
1112832	803070	34	231100	112	1356696	801640	24	432830	115	3193400	801865	31	281040	126

S-ABA / ABA Cross Reference List

S-ABA / ABA OEM Karşılaştırma Listesi

OEM NO	AYS S-ABA CODE	PAGE NO	AYS ABA CODE	PAGE NO	OEM NO	AYS S-ABA CODE	PAGE NO	AYS ABA CODE	PAGE NO	OEM NO	AYS S-ABA CODE	PAGE NO	AYS ABA CODE	PAGE NO
3193401	801870	31	281050	126	4731675			283000	107	9317026	800055	44	320234	148
3193402	800675	31	309870	128	4731683	801705	19	280800	106	9319035	800270	65	417701	159
3193403	800680	31	309880	128	4731691	801700	19	280700	106	9319121	800070	39	351700	159
3231273	801380	70	380400	177	4731709			563163	110	9319179	800070	39	451970	159
3231343			428400	177	4731717			563172	111	9319299	800290	66		
3263623	803290	28	423850	121	4731725	801630	22	280300	105	9518357	800275	68	521040	184
3268603	801380	70	380400	177	4731733	801635	22	280400	105	9524585	801865	31	281040	126
4000165	800060	64	508900	173	4731741			282200	107	9524586	801870	31	281050	126
4072733			558530	147	4731758			282300	107	9524856	800675	31	306870	127
4692759	802725	49	565851	155	4731766	800005	18			9524857	800680	31	306880	127
4695754	802725	49	567851	155	4731774	800010	18			10551437	800690	42	500880	146
4731006			584820	104	4731782	800015	18			10551439	800685	42	500870	145
4731014			583660	104	4731790	800020	18			10556832	800615	42	578550	146
4731022	801560	19	250100	98	4731808	800025	18			10567742	800620	42	578560	146
4731030	801720	20	283700	101	4731816	800030	18			10613835	800055	44	320134	148
4731048	801725	20	250400	98	4731840	800070	39			10622076	803670	43	210016	182
4731055			290300	102	4731857	800060	64			10622076	803670	43	508701	174
4731063			290200	101	4737789	803445	34	593850	131	10886663			334720	164
4731071	801850	20	250200	98	4880708	803015	34	414850	129	10889926			334710	164
4731089	801735	20	382770	103	4940871	802760	33	384040	129	10889962			334710	164
4731097	801845	20	588940	105	6034001			302521	150	10889963			334720	164
4731105			359650	141	6034002			302511	150	10891012	803095	59	360100	165
4731113	800005	18			6034008	801180	46	357011	150	10901188			333220	164
4731121	800010	18			6034010	801185	46	357010	150	10901199	800565	57	325550	164
4731139	801740	20	251800	99	6034011	801190	46	357020	150	10901200	800570	57	325560	164
4731147	800030	18			6518525	802900	44	368040	154	10907244	802770	58	305040	164
4731154	800025	18			6863906	802605	33	261710	126	10907245	802250	58	305600	164
4731162			487040	104	6863907	802600	33	261700	126	10907246	802255	58	305610	164
4731170			487050	104	6864707	800520	30	553560	130	11013281			210800	152
4731188	802575	21	251900	99	6864708	800515	30	553550	130	11013284	800465	70	380000	177
4731196	800015	18			6869601	802905	48	260900	151	11013285	800470	70	380100	177
4731204	800020	18			8196083	800740	31	367260	129	11015752			480160	178
4731212	801825	20	250900	98	8226963	802060	47	327600	151	11049395	802940	34	261600	126
4731220	801830	20	251000	98	8226964	802065	47	327610	151	12103554	801590	26	242600	119
4731238	801840	62	210905	153	8228242	802905	48	260900	151	12103631	801595	26	242700	119
4731246			210800	152	8228243	802900	44	368040	154	14512017	800065	51	435802	158
4731253			210900	153	8228543	802900	44	368040	154	17222353	803635	65	398860	172
4731261			377350	102	8398385	802145	32	356610	129	17222354	800070	39	326862	169
4731279			377360	103	8398386	802140	32	356600	129	21217568	803635	65	398860	172
4731287	801570	19	252000	99	8550578	802915	28	502041	154	21217569	800070	39	326862	169
4731295	800015	18			8550903	802840	33	585040	154	21222694	800060	64	508900	173
4731303	800020	18			8550963	802830	48	365040	154	21222873	802300	39	322601	140
4731311	803775	42	490320	144	9000100	800060	64	508900	173	21222874	802305	39	322611	140
4731329	800015	18			9002105	800080	70	435803	176	21222924	802100	51	322602	172
4731337	800020	18			9002121	801300	66	410000	159	21222925	802105	51	322612	172
4731345	802575	21	251700	99	9002122	801305	67	250690	159	21223694	800060	64	508900	173
4731352			501680	104	9002137	802260	67	250601	182	21224345	800060	64	361970	172
4731360			501690	104	9002138	802265	67	250610	182	21225220	800610	64	437560	173
4731386	803775	42	210200	143	9002153	800965	66	566010	160	21225221	800595	64	437550	173
4731394	801705	19	250800	98	9002154	800970	66	566020	160	21225222	800610	64	437560	173
4731402	801700	19	250700	98	9002201	800975	66	414010	159	21226978	803640	65	437860	173
4731410	800055	44	320134	148	9002202	800980	66	414020	159	21227325	800070	39	361760	129
4731428	800055	44	320134	148	9002221	800300	66	274680	159	21227325	800070	39	361760	129
4731436	800055	44	320234	148	9002222	800295	66	274690	158	21229249	800060	64	508900	173
4731444			515060	149	9002224	801300	66	410000	159	21229250	802300	39	322601	140
4731451			515070	150	9002225	801305	67	250690	159	21229251	802305	39	322611	140
4731469			312630	147	9002233			248710	158	21229280	800595	64	437550	173
4731477			312640	148	9002234			248720	158	21229281	800610	64	437560	173
4731576			562660	110	9002251	802260	67	250601	182	21229285	802310	68	437600	175
4731584	800010	18	282800	107	9002252	802265	67	250610	182	21229286	802315	68	437610	175
4731592	800005	18	282900	107	9002281	803600	67	248970	159	21229290	800060	64	361970	172
4731600	803425	23	283300	108	9007270	802915	28	319040	120	40877596	800070	39	326862	169
4731618	801805	23	281500	106	9007271	802090	27	241600	118	41217569	800070	39	326862	169
4731626	801810	23	281600	106	9007272	802095	27	241700	118	42531790			428400	177
4731634	801720	20	280900	106	9007273	800750	25	240902	117	42531791	801380	70	380400	177
4731642	801725	20	281000	106	9007807	802095	27	583610	122	42536274			428400	177
4731659	801735	20	281400	106	9007808	802090	27	583600	122	42536275	801380	70	380400	177
4731667			283100	107	9113311	803315	67	430000	174	42545954	803290	28	472850	177



Automatic Brake Adjuster / Otomatik Fren Ayar Kolu.
 (Self Setting) Automatic Brake Adjuster / Tam Otomatik Fren Ayar Kolu.
 * CS > Customer Specific / Özel İmalat

ALL ORIGINAL NUMBERS, MARKS AND MODELS FROM VEHICLE MANUFACTURERS LISTED IN THIS CATALOGUE ARE FOR COMPARISON PURPOSES ONLY AND MAY NOT BE USED IN INVOICES TO VEHICLE OWNERS OR RESELLERS / ORJINAL ÜRÜN NUMARALARI MÜŞTERİYİ BİLGİLENDİRME VE ÜRÜNE REFERANS AMAÇLI KULLANILMIŞTIR.

S-ABA / ABA Cross Reference List

S-ABA / ABA OEM Karşılaştırma Listesi



OEM NO	AYS S-ABA CODE	PAGE NO	AYS ABA CODE	PAGE NO	OEM NO	AYS S-ABA CODE	PAGE NO	AYS ABA CODE	PAGE NO	OEM NO	AYS S-ABA CODE	PAGE NO	AYS ABA CODE	PAGE NO
44015510	802300	39	322601	140	633106150	801360	42	373680	145	3464201538	801720	20	283700	101
44015520	802305	39	322611	140	633106650	803290	28	578520	178	3464201638	801725	20	250400	98
44015700	800070	39	361760	129	633107430			578770	146	3574200538	802575	21	251900	99
44015700	800070	39	361760	129	633107440			578780	146	3574200638	802540	20	254500	101
44015800	803575	46	438700	151	633107720	803185	25	324524	114	3574200738	802545	21	254600	101
44016010			351500	150	633107870	800465	70	380000	177	3574200938			390220	103
44016020			351501	150	633107880	800470	70	380100	177	3574201038			390230	103
44016210	800060	64	508900	173	656995104			210804	177	3574201138			377350	102
44016220	800060	64	508900	173	656995105			210902	177	3574201238			377360	103
70115331	801720	20	283700	101	1465300151	802890	30	470040	124	3574201338	801705	19	250800	98
70115348	800010	18			1465300161			567970	124	3574201438	801700	19	250700	98
82460800			480160	178	1465300611	802935	30	385850	123	3574201538	801705	19	250600	98
82460830			480170	178	1465300711	803650	30	467860	183	3574201638	801700	19	250500	98
85100231	802145	32	356610	129	1465300811	802935	30	386850	123	3634200138			378660	103
93001236	801830	20	254300	101	1465300911	801745	29	407850	124	3714200038	802575	21	252300	99
93160850	803290	28	500851	145	1465300921	801750	29	407860	124	3764200038	801715	20	599450	105
105002001	800065	51	435802	158	1465301011	801830	20	330100	156	3764200138	801710	19	599440	105
105003001	800075	68	435800	174	1465301021	801825	20	330000	156	3764200238	800005	18	373960	102
105005001	803775	42	210200	143	1465301211	801830	20	436860	124	3764200338	800010	18	373970	102
105006001	802055	27	242101	118	1465301221	801825	20	436850	124	3814200238			363800	102
105007001	802050	27	242001	118	1465301311	801830	20	436860	124	3814200338			363810	102
105008001	800755	26	240601	117	1465301321	801825	20	436850	124	3834200438	800030	18		
105010001	800075	68	435800	174	2175015600	800070	39	210000	139	3834200538	800025	18		
105011001	800065	51	435802	158	2175016800	800070	39	210000	139	3844207438			303960	102
105012001	800055	44	320134	148	2175016900	800055	44	320134	148	3854201138	801800	20	251400	99
105012011	800055	44	320134	148	2175020200	800070	39	210000	139	3854201238	801795	20	251300	98
105012111	800055	44	320134	148	2175021900	800060	64	470863	142	3854201738	800035	18		
105013001	803675	40	321200	140	2700020000	800885	49	330300	156	3854201838	800040	18		
105015001	801590	26	242600	119	2700021000	800895	49	357263	156	3854207438			303960	102
105016001	801595	26	242700	119	2700031000	800885	49	431260	157	3874200038	801825	20	250900	98
105017001	800060	64	508900	173	2700039000	800895	49	330200	156	3874200138	801830	20	251000	98
105017011	800060	64	508900	173	2700040000	803735	50	563861	157	3874200238	800010	18		
105017111	800060	64	508900	173	2700045000	800885	49	330400	156	3874200338	800005	18		
105018021	800070	39	435300	141	2700046000	800885	49	330400	156	3894200238	801735	20	371770	102
105019001	800055	44	320234	148	2700048000	803740	50	563862	157	3894200338	801720	20	283700	101
105024001			359650	141	2700052000	800890	49	330500	156	3894200438	801725	20	250400	98
105024111			359650	141	2700054000	800905	49	276261	155	3894200738	801735	20	382770	103
105029001	800060	64	508900	173	3014201138	801570	19	252000	99	3894205438			563160	104
105029111	800055	44	320234	148	3054200238	801560	19	250100	98	3934200038	801845	20	588940	105
105031011	800060	64	508900	173	3054200438			584820	104	3964200038	801735	20	382770	103
105031111	803670	43	508701	174	3054200538			583660	104	4175008500	800070	39	210000	139
105031111	803670	43	210016	182	3054202638	801560	19	250100	98	4175008501	800070	39	435300	141
270004500	800885	49	330400	156	3054202738			584821	105	4175013900			366630	141
441176005	801990	37	427180	136	3054202938			584822	105	4175014000			366640	141
474801790	802340	53	264600	161	3054203038			584822	105	4175014100			359650	141
474801801	803280	53	310800	161	3074200038			353660	182	4175014400	800070	39	210030	139
474801811	803280	53	310800	161	3074200138			290200	101	4175014900			371630	141
474901180	802345	53	264610	161	3074200238			290300	102	4175015000			371640	141
501206318	803275	71	474851	178	3074200338	801850	20	250200	98	4175015401	803620		470862	142
517482392	800055	44			3074201738			369160	102	4175018100	803190	40	311500	140
517490180	801825	20	250900	98	3074201838			369170	102	4175018400	800055	44	320234	148
517490190	803070	34	231100	112	3074202138			586520	105	4175020800	802305	39	322611	140
517490200	800020	18			3074202238			586530	105	4175020900	802300	39	322601	140
517490210	800010	18			3414201638			391260	103	4175021100	800060	64	470863	142
517496630	801825	20	250900	98	3414201738			391250	103	4175021500	801340	39	321400	140
557482873	800055	44			3434350100	800060	64	470863	142	4175021600	801345	39	321500	140
633101440	802915	28	319040	120	3434350202	800070	39	210000	139	4175022500	803675	40	321200	140
633104280	803290	28	500851	145	3434350300	800070	39	210030	139	4175022600	803210	40	492520	142
633104590	803000	42	500520	145	3434350400	800060	64	470863	142	4175022601	803210	40	492520	142
633104610			500530	145	3434350500			359650	141	4175022800	800070	39	210000	139
633104620			500540	145	3434350800	800070	39	435300	141	4175023000	800800	39	418260	183
633104690			373540	145	3434351400	800070	39	210000	139	4175023100	803210	40	321300	140
633104700			373530	145	3434351500	800070	39	210030	139	4175023500	802275	79	503600	142
633104950	803000	42	500520	145	3454200738	801825	20	254000	101	4175023600	802285	39	503610	142
633105040	800070	39	210000	139	3454200838	801830	20	254100	101	4175023700			503840	142
633105050	800055	44	326320	149	3454201238			475490	103	4175023800			503830	142
633105620	800075	68	326863	157	3454207338	801715	20	599450	105	4175023900	800055	44	320134	148
633106140	801365	42	380501	145	3455207238	801710	19	599440	105	4175024000	800070	39	435300	141

S-ABA / ABA Cross Reference List

S-ABA / ABA OEM Karşılaştırma Listesi

OEM NO	AYS S-ABA CODE	PAGE NO	AYS ABA CODE	PAGE NO	OEM NO	AYS S-ABA CODE	PAGE NO	AYS ABA CODE	PAGE NO	OEM NO	AYS S-ABA CODE	PAGE NO	AYS ABA CODE	PAGE NO
4175024100			503650	142	5000568147			313310	134	5430053192	801500	35	220304	131
4175024200			503660	142	5000785203			318530	135	5430053193	801505	35	220403	132
4175024700	800070	39	210030	139	5000785204			318540	135	5430060288	802420	37	473600	184
4175024800	800070	39	435804	141	5000785205			302560	133	5430060289	802425	37	473610	184
4175024900	800070	39	210000	139	5000785206			302570	134	5430260288	802420	37	473600	184
4175025000	800435	39	470870	142	5000787230			578140	139	5465301811	802635	30	385851	123
4175025100	800440	39	470880	142	5000787231			578150	139	5465301911			204790	123
4175025700	803185	25	321100	140	5000787264	801540	36	581080	139	5465301921			204800	123
4175026100	800070	39	267900	139	5000787265	801545	36	581090	139	5465302011			436490	183
4175026200	800135	39			5000788696	801550	36	221300	132	5465302021			436500	183
4332065000	801825	20	250900	98	5000788697	801555	36	221400	133	5465303111	801935	29	203170	122
4332065010	801830	20	251000	98	5000789892	801520	35	220100	131	5465303121	801940	30	203180	122
4332067000	800020	18			5000789893	801525	35	220200	131	5465303211	801915	29	299170	123
4332067010	800015	18			5000789894	801510	35	220301	131	5465303221	801920	29	299180	123
4332067020	800005	18			5000789895	801515	35	220400	131	5465303311	803065	30	378850	123
4332067030	800010	18			5000791212	802445	37	221000	132	5465303411			204490	123
4332067040	800020	18			5000791213	802440	37	220900	132	5465303421			204500	123
4332067050	800015	18			5000816365	800070	39	210000	139	5465303511	801270	29	407680	123
4332067060	800005	18			5000882316			313510	134	5465303521	801275	29	407690	124
4332067070	800010	18			5000882317			313520	134	5465303611	803645	30	385860	123
4332067080	800020	18			5000928591			302531	133	5801108031	801460	63	246600	182
4332067090	800015	18			5000928592			302541	133	5801108032	801465	63	246601	182
4332067100	801725	20	250400	98	5010013393	801520	35	221500	133	5801108076	801450	61	246610	182
4332067110	801720	20	283700	101	5010013394	801525	35	221600	133	5801108078	801455	61	246611	182
4335761120	801845	20	588940	105	5010037900	803455	38	473040	137	5810111404	802445	37	236610	133
4335761130	801845	20	588940	105	5010056685	801520	35	220100	131	5810111405	802440	37	236600	133
4335761240	801735	20	382770	103	5010056686	801525	35	220200	131	6174200238	801740	20	251800	99
4335761250	801735	20	382770	103	5010067156	802005	37	479170	137	6174200338	800005	18		
4335765020	800010	18			5010067157	802010	37	479180	137	6174200438	800010	18		
4335765030	800005	18			5010098831	802465	38	220800	132	6194200038	800015	18		
4335765080			487050	104	5010098832	802460	38	220700	132	6194200138	800020	18		
4335765090			487040	104	5010098862	801985	36	433170	136	6194200238	800015	18		
4335767000	801720	20	283700	101	5010098863	801990	37	433180	136	6194200338	800020	18		
4335767010	801725	20	250400	98	5010098893	802005	37	407170	135	6194200638	800010	18		
4335767060			290103	101	5010098894	802010	37	407180	135	6194200738	800005	18		
4335767070			570780	104	5010145883	801490	35	220105	131	6204200038	801720	20	283700	101
4335767080	801830	20	251000	98	5010145884	801495	35	220203	131	6204200138	801725	20	250400	98
4335767090	801825	20	250900	98	5010152965	803470	38	221700	133	6204200238	801735	20	382770	103
4335767100	800015	18			5010197577	801985	36	427170	136	6204200338	801735	20	382770	103
4335767110	800020	18			5010197578	801990	37	427180	136	6214200038	801830	20	251000	98
4335767120	800015	18			5010201995	803515	38	560851	138	6214200138	801825	20	250900	98
4335767130	800020	18			5010216246	802005	37	388170	135	6234200038			290103	101
4335767140	801720	20	283700	101	5010216247	802010	37	388180	135	6234200138			570780	104
4335767150	801725	20	250400	98	5010216843	802430	37	220902	132	6234200238			290103	101
4335767220			501680	104	5010216844	802435	37	221002	132	6234200338			570780	104
4335767230			501690	104	5010216904	801490	35	416080	136	6234200438			487050	104
4335767240	800015	18			5010216905	801495	35	416090	136	6234200538			487040	104
4335767250	800020	18			5010260023	802440	37	427940	136	6234200638			487050	104
5000029286			464150	109	5010260024	802445	37	427950	136	6234200738			487040	104
5000029287			464140	108	5010260027	802460	38	221100	132	6234200838	801845	20	588940	105
5000031229			303330	134	5010260028	802465	38	221200	132	6234200938	801845	20	588940	105
5000031230			303340	134	5010260085	801995	37	423170	136	6234201238	800015	18		
5000037954	801470	35	316680	134	5010260086	802000	37	423180	136	6234201338	800020	18		
5000037955	801475	35	316690	135	5010260087	801975	36	590170	139	6234201438	800015	18		
5000038237			306660	134	5010260088	801980	36	590180	139	6234201538	800020	18		
5000038238			306650	134	5010260089	801975	36	447170	137	6234201838	802580	21	254400	101
5000445830	803460	38	220500	132	5010260090	801980	36	447180	137	6254200638			584822	105
5000445898	803455	38	220600	132	5010260115	801965	36	512170	138	6524200038	800015	18		
5000467382			569540	138	5010260116	801970	36	512180	138	6524200138	800020	18		
5000467831			569530	138	5010260344	802005	37	407170	135	6524200238	802575	21	251700	99
5000467832			569540	138	5010260345	802010	37	407180	135	6544200038			501680	104
5000470830	802000	37	500180	138	5010260379	801530	35	591080	139	6544200138			501690	104
5000470831	801995	37	500170	138	5010260380	801535	36	591090	139	6554200038	800005	18		
5000470911			569200	138	5430016304			459050	137	6554200138	800010	18		
5000470912	802015	37	569180	138	5430016305			459040	137	6584200038			501680	104
5000504467	801035	34	357012	135	5430016310	803535	38	312040	134	6584200138			501690	104
5000504468	801040	35	357021	135	5430016341			259940	133	6584200238	800015	18		
5000568146			313320	134	5430016393	803530	38	312041	134	6584200338	800020	18		



ABA
Automatic Brake Adjuster / Otomatik Fren Ayar Kolu.
S-ABA
(Self Setting) Automatic Brake Adjuster / Tam Otomatik Fren Ayar Kolu.
* CS > Customer Specific / Özel İmalat

ALL ORIGINAL NUMBERS, MARKS AND MODELS FROM VEHICLE MANUFACTURERS LISTED IN THIS CATALOGUE ARE FOR COMPARISON PURPOSES ONLY AND MAY NOT BE USED IN INVOICES TO VEHICLE OWNERS OR RESELLERS / ORJINAL ÜRÜN NUMARALARI MÜŞTERİYİ BİLGİLENDİRME VE ÜRNE REFERANS AMAÇLI KULLANILMIŞTIR.

S-ABA / ABA Cross Reference List

S-ABA / ABA OEM Karşılaştırma Listesi



OEM NO	AYS S-ABA CODE	PAGE NO	AYS ABA CODE	PAGE NO	OEM NO	AYS S-ABA CODE	PAGE NO	AYS ABA CODE	PAGE NO	OEM NO	AYS S-ABA CODE	PAGE NO	AYS ABA CODE	PAGE NO
6954207038	803425	23	392850	103	81506106084	801725	20	281000	106	81506106215	800005	18	282900	107
6994200538	801825	20	253800	101	81506106085	803425	23	474850	109	81506106216	803425	23	489521	109
6994200638	801830	20	253900	101	81506106086			464150	109	81506106217	803425	23	283300	108
7701012134			302520	133	81506106086	801850	20	250200	98	81506106218			563172	111
7701012135			302510	133	81506106087			464140	108	81506106219			563163	110
8235000415	803775	42	210200	143	81506106087	801635	22	280400	105	81506106220	801630	22	280300	105
8238000415	803775	42	210200	143	81506106091	800875	22	566260	111	81506106221	801635	22	280400	105
8238000835	803775	42	210200	143	81506106098	800875	22	282101	107	81506106222			282200	107
8283000648	803775	42	210200	143	81506106101			572970	111	81506106223			282300	107
8283000753	803775	42	490320	144	81506106108			563171	110	81506106225			563570	111
8285000079	802470	41	557600	145	81506106109			563162	110	81506106226	803415	23	283200	108
8285000080	802475	41	557610	145	81506106123	803415	23	283200	108	81506106227	803425	23	413521	183
8285000415	803775	42	210200	143	81506106126			282200	107	81506106228	801705	19	280600	106
8285000538	802400	41	553600	144	81506106127			282300	107	81506106229	801700	19	280500	105
8285000910	802395	41	364610	144	81506106128	801630	22	280300	105	81506106231	801735	20	281400	106
9424200038	800015	18			81506106129	801635	22	280400	105	81506106234	801810	23	281600	106
9424200138	800020	18			81506106137	803425	23	283300	108	81506106235	801805	23	281500	106
9424200238	800005	18			81506106139	800005	18	282900	107	81506106246	800020	18	442180	183
9424200338	800010	18			81506106140	800010	18	282800	107	81506106247	800015	18	442190	183
9424200438	800005	18			81506106149			283000	107	81506106251	800380	22		
9424200538	800010	18			81506106150			283100	107	81506106252	800385	22		
9424200638	801720	20	283700	101	81506106151	801735	20	281400	106	81506106253	800360	21		
9424200738	801725	20	250400	98	81506106153	801720	20	280900	106	81506106254	800375	22		
9424200838	800020	18			81506106154	801725	20	281000	106	81506106255	800370	21		
9424200938	800015	18			81506106157	803415	23	283200	108	81506106256	800365	21		
9424201038	801830	20	251000	98	81506106160			589310	111	81506106258	800390	22		
9424201138	801825	20	250900	98	81506106161			589300	111	81506106259	800370	21		
9424201238	800015	18			81506106165	801805	23	281500	106	81506106260	800375	22		
9424201338	800020	18			81506106166	801810	23	281600	106	81506106261	800380	22		
9424290338	800010	18			81506106167	800875	22	282101	107	81506106262	800385	22		
9454200038	800015	18			81506106169			282300	107	81506106263	800360	21		
9454200138	800020	18			81506106170			282200	107	81506106264	800365	21		
9454200238	800005	18			81506106173			563570	111	81506106266	800390	22		
9454200338	800010	18			81506106174			500471	110	81506107154	801725	20	281000	106
9454200438	800045	18			81506106175			500461	110	81506108151	801735	20	281400	106
9454200538	800035	18			81506106176	800010	18	282800	107	81506109151	801735	20	281400	106
9454200638	800040	18			81506106177	800005	18	282900	107	81998033225	801805	23	281500	106
9454200738	800030	18			81506106178			283100	107	81998033226	801810	23	281600	106
9454200838	800025	18			81506106179			283000	107	82830003040	801775	78	515850	144
9454200938	800090	18			81506106180	803415	23	283200	108	82830003080			520940	144
9454201038	800340	19			81506106181	801700	19	280700	106	82830003090			520950	144
9454201138	800345	19			81506106182	801705	19	280800	106	82830003360	800830	40	348260	143
9454201238	800330	18			81506106183			281900	106	82830005520	802370	40	312601	143
9454201338	800335	19			81506106184			282000	107	82830005530	802375	40	312611	143
9454201438	800350	19			81506106187	801635	22	280400	105	82830005890	802670	41	350300	143
9454201538	800355	19			81506106188	801630	22	280300	105	82830005900	802675	41	350400	144
9464200838	800025	18			81506106189			563162	110	82830006480	803775	42	210200	143
9474200738	800030	18			81506106190			563171	110	82830007530	803775	42	490320	144
9484200538	800035	18			81506106191			563163	110	82830007570	803545	41	350100	143
9494200638	800040	18			81506106192			563172	111	82850000790	802470	41	557600	145
9543311002	803315	67	430100	174	81506106193	803425	23	283300	108	82850000800	802475	41	557610	145
40672053000	803210	40	321300	140	81506106194	803425	23	489521	109	82850000810			557530	144
50007898894	801510	35	220301	131	81506106197			410970	183	82850000820			557540	145
50007898895	801515	35	220400	131	81506106199	801700	19	280500	105	82850000890	802405	41	553610	144
54300116310	803535	38	312040	134	81506106200	801705	19	280600	106	82850000900	802400	41	553600	144
81056106150			283100	107	81506106201	803425	23	413521	183	82850000910	802395	41	364610	144
81056106206			283100	107	81506106203	801700	19	280700	106	82850000920	802390	41	364600	144
81506106063			281900	106	81506106204	801705	19	280800	106	82850002130	802355	40	385610	144
81506106064			282000	107	81506106205			283000	107	82850002140	802350	40	385600	144
81506106065			562660	110	81506106206			283100	107	82850004150	803775	42	210200	143
81506106067			498970	110	81506106207			500461	110	82850005370	802405	41	553610	144
81506106077	801635	22	280400	105	81506106208			500471	110	82850005380	802400	41	553600	144
81506106078	801630	22	280300	105	81506106209	800875	22	282101	107	82850005390	802405	41	553610	144
81506106079			563163	110	81506106210	801810	23	281600	106	82852450000			304710	143
81506106080			563172	111	81506106211	801805	23	281500	106	82852460000			304720	143
81506106081	801735	20	281400	106	81506106212	801725	20	281000	106	89200440743	802900	44	369040	175
81506106082			562660	110	81506106213	801720	20	280900	106	99100330822	802455	69	508610	175
81506106083	801720	20	280900	106	81506106214	800010	18	282800	107	99100330823	802450	68	508600	175

S-ABA / ABA Cross Reference List

S-ABA / ABA OEM Karşılaştırma Listesi

OEM NO	AYS S-ABA CODE	PAGE NO	AYS ABA CODE	PAGE NO	OEM NO	AYS S-ABA CODE	PAGE NO	AYS ABA CODE	PAGE NO	OEM NO	AYS S-ABA CODE	PAGE NO	AYS ABA CODE	PAGE NO
0003520840	801600	70	478420	178	0517482091	800060	64	360760	149	070112507	801560	19	250100	98
0003520940	801605	71	478430	178	0517482092	800060	64	360760	149	070114304			290200	101
002275	800070	39	210000	139	0517482110	803675	40	321200	140	070114305			290300	102
003308	800070	39	435300	141	0517482112	803675	40	321200	140	070265600	801860	24	230400	111
0067148S1	800720	57	357260	165	0517482120	800055	44	320234	148	070276000			210800	152
008671	800055	44			0517482122	800055	44	320234	148	070276010	800465	70	380000	177
009197	800060	64	361970	172	0517482130	800060	64	360760	149	070276011	800470	70	380100	177
0092419	802200	27	242000	118	0517482132	800060	64	360760	149	070276100			210900	153
0092420	802205	28	242100	118	0517482140	800055	44	320234	148	070277000	801775	78	515850	144
0097774	802595	28	243300	120	0517482142	800055	44	320234	148	0740321			455650	121
0097774	802595	28	243300	120	0517482200	800060	64	360760	149	0740322			455660	121
0097775	802590	28	243200	120	0517482202	800060	64	360760	149	0755247	801755	26	240300	117
0097775	802590	28	243200	120	0517482210	800055	44	320134	148	0755248	801760	27	240400	117
014265271135	803775	42	490320	144	0517482212	800055	44	320134	148	0755616			455770	121
0159556	802050	27	242001	118	0517482220	800055	44	320134	148	0755617			455780	121
0159557	802055	27	242101	118	0517482222	800055	44	320134	148	080110802	801850	20	250200	98
0159558	802050	27	241800	118	0517482240	800055	44	320234	148	080250000	801840	62	210905	153
0159559	802055	27	241900	118	0517482242	800055	44	320234	148	08164954Z			313310	134
0159560	800755	26	240601	117	0517482260	800060	64	360760	149	08164956B			303340	134
0159561	802645	28	242301	119	0517482262	800060	64	360760	149	08164958D			303330	134
0159562	802640	28	242201	118	0517482310	800055	44	320234	148	08166250H			302560	133
0159563	801755	26	240101	116	0517482312	800055	44	320234	148	08166251J			302570	134
0159564	801760	27	240201	117	0517482320	800060	64	360760	149	08166252K			318530	135
0159565	800755	26	243000	119	0517482322	800060	64	360760	149	08166253L			318540	135
0159569	802930	28	241201	117	0517482400	800060	64	360760	149	082460300	801855	24	230300	111
0159576	800780	26	240700	117	0517482402	800060	64	360760	149	082460820			480160	178
0159577			461650	122	0517482430	800060	64	360760	149	0834984	802195	27	362610	120
0159578	803085	28	457852	121	0517482432	800060	64	360760	149	09002105	800080	70	435803	176
0159587	802595	28	242300	119	0517482450	800060	64	360760	149	09002113	800070	39	351700	159
0159588	802590	28	242200	118	0517482452	800060	64	360760	149	09002209	800955	66	248010	158
0159589	801590	26	242600	119	0517482470	800055	44	320234	148	09002210	800960	66	248020	158
0159590	801595	26	242700	119	0517482472	800055	44	320234	148	09002265			248940	182
0159591	800785	26	240600	117	0517482490	800055	44	320134	148	09002266			248950	182
0159592	800780	26	241500	118	0517482492	800055	44	320134	148	09012061	800810	66	374260	159
0199878	803290	28	472850	177	0517482562	800055	44	320234	148	09319299	800290	66		
0199878	803290	28	472850	177	0517482632	800055	44	320134	148	10017649Z	800080	70	435803	176
03884204	802600	33	261700	126	0517482633	800055	44	320134	148	1021029692515			577800	162
05010098860	801985	36	496170	137	0517482642	800060	64	360760	149	1021029692516			577790	162
05010098861	801990	37	496180	137	0517482672	800055	44	320134	148	1021029692517	800635	55	436550	161
05010260117	801955	36	512171	138	0517482742	800055	44	320134	148	1021029692518	800640	55	436560	162
05010260118	801960	36	512181	138	0517482802	800060	64	360760	149	1021029692521			287460	161
0501205935	803290	28	578520	178	0517490200	800020	18			1021029692522			287470	161
0501207555	803290	28	472850	177	0517490210	800010	18			1021029692945	803255	55	546040	161
0501309389			210800	152	0537538	802920	28	241100	117	120015100002	800070	39	438701	169
0501309389			210800	152	0538470	802050	27	471601	122	135027/2			500530	145
0501309398			210800	152	0538471	802055	27	471611	122	14578 (SBT)	803455	38	473040	137
0501309399			210900	153	0557482021	800055	44	320134	148	148214/4			373540	145
0501314043	802570	71	380300	177	0557482031	800055	44	320234	148	148215/4			373530	145
0501314349			480160	178	0557482121	800055	44	320134	148	157954/2	801365	42	380501	145
0501314350			480170	178	0557482190	800055	44	320134	148	157955/2	801360	42	373680	145
0501314479	800465	70	380000	177	0557482200	800055	44	320234	148	164290/2			500540	145
0501314480	800470	70	380100	177	0557482220	800055	44	320134	148	171400/2			578770	146
0501317229			210902	177	0557482270	800055	44	320234	148	171401/2			578780	146
0501317230			210804	177	0557482430	800055	44	320134	148	3291747R	800735	67	357261	174
0501317231			210902	177	0557482432	800055	44	320134	148	3292691R1	800885	49	330300	156
0501317231C			210902	177	0557482440	800055	44	320234	148	3292691R91	800885	49	330300	156
0517454410	801345	39	321500	140	0557482442	800055	44	320234	148	3292692R1	800895	49	357263	156
0517454420	801340	39	321400	140	0557482552	800055	44	320134	148	329269R1	800895	49	357263	156
0517456710			515060	149	0557482592	800055	44	320234	148	3293961R1	800885	49	330400	156
0517456720			515070	150	0557482652	800055	44	320134	148	3884202	802605	33	261710	126
0517456810	801335	44	320600	149	0557482672	800055	44	320234	148	4003/F	802240	45	471600	150
0517456820	801330	44	320500	149	0557482682	800055	44	320134	148	4004/F	802245	45	471610	150
0517482020	800055	44	320134	148	0557482872	800055	44	320134	148	442790570000			446530	163
0517482021	800055	44	320134	148	0557482873	800055	44			442790580000			446540	163
0517482022	800055	44	320134	148	0557482932	800055	44	320134	148	442795200000	801450	61	246610	182
0517482030	800055	44	320234	148	06310024	801520	35	220100	131	442795210000	801455	61	246611	182
0517482031	800055	44	320234	148	06310025	801525	35	220200	131	4W1000	800060	64	508900	173
0517482032	800055	44	320234	148	06310030	800065	51	435802	158	4W1005	800055	44	320134	148



Automatic Brake Adjuster / Otomatik Fren Ayar Kolu.
S-ABA
(Self Setting) Automatic Brake Adjuster / Tam Otomatik Fren Ayar Kolu.

* CS > Customer Specific / Özel İmalat

ALL ORIGINAL NUMBERS, MARKS AND MODELS FROM VEHICLE MANUFACTURERS LISTED IN THIS CATALOGUE ARE FOR COMPARISON PURPOSES ONLY AND MAY NOT BE USED IN INVOICES TO VEHICLE OWNERS OR RESELLERS / ORJINAL ÜRÜN NUMARALARI MÜŞTERİYİ BİLGİLENDİRME VE ÜRÜNE REFERANS AMAÇLI KULLANILMIŞTIR.

S-ABA / ABA Cross Reference List

S-ABA / ABA OEM Karşılaştırma Listesi



OEM NO	AYS S-ABA CODE	PAGE NO	AYS ABA CODE	PAGE NO	OEM NO	AYS S-ABA CODE	PAGE NO	AYS ABA CODE	PAGE NO	OEM NO	AYS S-ABA CODE	PAGE NO	AYS ABA CODE	PAGE NO
4W1010	800055	44	320234	148	4W2145	800020	18			4W2495	800585	57	536550	166
4W1015	800080	70	435803	176	4W2150	801735	20	382770	103	4W2500	800590	57	536560	166
4W1020	800065	51	435802	158	4W2155	801830	20	251000	98	4W2505			210800	152
4W1025	800075	68	435800	174	4W2160	801825	20	250900	98	4W2510			210900	153
4W1030	803620		470862	142	4W2165	800015	18			4W2515	800755	26	243000	119
4W1035	803725	67	326860	159	4W2170	800895	49	357263	156	4W2520	801895	25	231700	112
4W1040	800060	64	470863	142	4W2175	800885	49	330400	156	4W2525	801900	25	231800	112
4W1045	800055	44	320134	148	4W2180	802775	58	575041	167	4W2530	802615	33	261400	126
4W1050	800065	51	435802	158	4W2185			391341	166	4W2535	802610	33	261300	125
4W1055	800070	39	326862	169	4W2190			391331	166	4W2540	802625	33	261401	126
4W1060	803655	51	326864	157	4W2195			495220	166	4W2545	802620	33	261301	125
4W1065	803170	64	468860	173	4W2200			494710	166	4W2550			302650	127
4W1070	803635	65	398860	172	4W2205			494720	166	4W2555			302540	126
4W1075	800070	39	435300	141	4W2210	801895	25	230700	112	4W2560			302530	126
4W1080			359650	141	4W2215	801900	25	230800	112	4W2565			520530	130
4W1085	800595	64	437550	173	4W2220	801855	24	230300	111	4W2570			520540	130
4W1090	800610	64	437560	173	4W2225	801510	35	220301	131	4W2575			302661	127
4W1095	800070	39	210030	139	4W2230	801525	35	220200	131	4W2580			302651	127
4W1105	800055	44	326320	149	4W2235	800885	49	330300	156	4W2585			390710	114
4W1110			366640	141	4W2240	801520	35	220100	131	4W2590			390720	114
4W1115	802300	39	322601	140	4W2245	801515	35	220400	131	4W2595			235410	113
4W1120	802305	39	322611	140	4W2250	800790	23	230100	111	4W2600	800460	23	405510	115
4W1125	803210	40	321300	140	4W2255	800275	68	566040	130	4W2605	800455	23	405500	115
4W1130			371640	141	4W2260	801860	24	230400	111	4W2610	800010	18	282800	107
4W1135			371630	141	4W2265	802660	25	231500	112	4W2615	800005	18	282900	107
4W1150	803170	64	534860	173	4W2270	802665	25	231600	112	4W2620	801630	22	280300	105
4W1160			366630	141	4W2280	802525	32	260201	125	4W2625	801635	22	280400	105
4W1165	803760	52	505860	158	4W2285	802495	32	260200	125	4W2630	801985	36	433170	136
4W1170	800060	64	361970	172	4W2290	802490	32	260100	124	4W2635	801990	37	433180	136
4W1175	803150	51	314525	157	4W2295	802980	34	261200	125	4W2640	802430	37	220902	132
4W1180	800070	39	361760	129	4W2300	802520	32	260101	124	4W2645	802435	37	221002	132
4W1185	803640	65	437860	173	4W2305	800785	26	240600	117	4W2650	802770	58	305040	164
4W1190			313630	182	4W2310	802060	47	327600	151	4W2655	802250	58	305600	164
4W1205	802310	68	437600	175	4W2315	803100	59	360200	165	4W2660			312660	128
4W1210	802315	68	437610	175	4W2320			334710	164	4W2665			312650	128
4W1215	801340	39	321400	140	4W2325	802905	48	260900	151	4W2670	802895	58	575042	167
4W1220	801345	39	321500	140	4W2330			333220	164	4W2675	800780	26	241500	118
4W1225	801310	43	312681	147	4W2335	802915	28	502041	154	4W2680	801900	25	230800	112
4W1230	801315	44	312691	147	4W2340			386220	166	4W2685			302662	127
4W2000	802915	28	319040	120	4W2345			385710	165	4W2690			302652	127
4W2005	800750	25	240902	117	4W2350			385720	166	4W2695			302660	127
4W2010	802050	27	242001	118	4W2355	800565	57	325550	164	4W2700	802065	47	327610	151
4W2015	802055	27	242101	118	4W2360			235400	113	4W2705	802990	34	583850	131
4W2020	801590	26	242600	119	4W2365	802255	58	305610	164	4W2710	803070	34	231100	112
4W2025	801595	26	242700	119	4W2370	803095	59	360100	165	4W2715			377350	102
4W2030	802920	28	241100	117	4W2375	802830	48	365040	154	4W2720			377360	103
4W2035	802640	28	242201	118	4W2380			391340	166	4W2725			418770	120
4W2040	802575	21	251900	99	4W2385			391330	166	4W2730			418780	120
4W2045	801740	20	251800	99	4W2390	800570	57	325560	164	4W2735	801650	24	235830	113
4W2050	800020	18			4W2395			461650	122	4W2740	801655	24	235840	113
4W2055	800015	18			4W2400			455650	121	4W2745	802725	49	565851	155
4W2060	800010	18			4W2405	802340	53	264600	161	4W2750			487040	104
4W2065	800005	18			4W2410	802345	53	264610	161	4W2755			487050	104
4W2070	801805	23	281500	106	4W2415	803280	53	310800	161	4W2760	800755	26	240601	117
4W2075	801810	23	281600	106	4W2420	802575	21	251700	99	4W2765	801725	20	250400	98
4W2080	801735	20	281400	106	4W2425			455660	121	4W2770	803315	67	430000	174
4W2085	803775	42	210200	143	4W2430	803175	59	325520	164	4W2775			500530	145
4W2090	801725	20	281000	106	4W2435			334720	164	4W2780			500540	145
4W2095	801720	20	280900	106	4W2440	801560	19	250100	98	4W2785	800465	70	380000	177
4W2100	801850	20	250200	98	4W2445	801720	20	283700	101	4W2790	800470	70	380100	177
4W2105	802645	28	242301	119	4W2450	802600	33	261700	126	4W2795	802445	37	221000	132
4W2110	802595	28	242300	119	4W2455	802605	33	261710	126	4W2800	802440	37	220900	132
4W2115	802050	27	241800	118	4W2460	803000	42	500520	145	4W2805	802090	27	241600	118
4W2120	802590	28	242200	118	4W2470	801795	20	251300	98	4W2810	802095	27	241700	118
4W2125	802055	27	241900	118	4W2475			571710	167	4W2815	801540	36	581080	139
4W2130	801570	19	252000	99	4W2480			571720	167	4W2820	801545	36	581090	139
4W2135	800030	18			4W2485	802140	32	356600	129	4W2825	802900	44	368040	154
4W2140	800025	18			4W2490	802145	32	356610	129	4W2830	801830	20	254100	101

S-ABA / ABA Cross Reference List

S-ABA / ABA OEM Karşılaştırma Listesi

OEM NO	AYS S-ABA CODE	PAGE NO	AYS ABA CODE	PAGE NO	OEM NO	AYS S-ABA CODE	PAGE NO	AYS ABA CODE	PAGE NO	OEM NO	AYS S-ABA CODE	PAGE NO	AYS ABA CODE	PAGE NO
4W2835	803090	58	360000	165	4W3175			210902	177	4W3540			233200	113
4W2840	801800	20	251400	99	4W3180			210804	177	4W3545			233210	113
4W2845	801840	62	210905	153	4W3185			563162	110	4W3550			578490	116
4W2850	801895	25	230700	112	4W3190			563171	110	4W3555			578500	116
4W2855	800015	18			4W3195			302560	133	4W3560	803365	55	581850	181
4W2860	803290	28	578520	178	4W3200			302570	134	4W3565	801240	55	474680	180
4W2865	802915	28	310040	153	4W3205	803460	38	220500	132	4W3570	801245	55	474690	180
4W2870	802005	37	479170	137	4W3210			319530	128	4W3575	802350	40	385600	144
4W2875	802010	37	479180	137	4W3215			318540	135	4W3580			259940	133
4W2880	802930	28	241201	117	4W3220			318530	135	4W3585			378530	175
4W2885	802915	28	583041	131	4W3225	801360	42	373680	145	4W3590			378540	175
4W2885	802880	33	261100	125	4W3230	801365	42	380501	145	4W3595			375050	182
4W2890			538660	167	4W3235	801490	35	220105	131	4W3600			375060	182
4W2895			538650	166	4W3240	801495	35	220203	131	4W3605	800255	73	584850	179
4W2900			319540	128	4W3245			558720	116	4W3610	803045	47	506850	184
4W2910	802460	38	220700	132	4W3250			558710	116	4W3615	801315	44	326690	182
4W2915	803300	38	409850	171	4W3255	802370	40	312601	143	4W3620	802900	44	369040	175
4W2920	801985	36	496170	137	4W3260	802375	40	312611	143	4W3625	800875	22	282101	107
4W2925	801990	37	496180	137	4W3265			283100	107	4W3635	802450	68	508600	175
4W2930	801705	19	250800	98	4W3270			283000	107	4W3640	802455	69	508610	175
4W2935	800505	70	484931	178	4W3275			578140	139	4W3645			428400	177
4W2940	801490	35	416080	136	4W3280			578150	139	4W3650	801380	70	380400	177
4W2945	801495	35	416090	136	4W3285	801715	20	599450	105	4W3655	801755	26	240101	116
4W2950	801825	20	254000	101	4W3290	801710	19	599440	105	4W3660	801760	27	240201	117
4W2955	800900	62	508261	170	4W3295	803290	28	472850	177	4W3665	800780	26	240700	117
4W2960	803290	28	500851	145	4W3300	803735	50	563861	157	4W3670			380540	168
4W2965	801775	78	515850	144	4W3305			554950	115	4W3675			380550	168
4W2970	801770	60	327860	152	4W3310			554940	115	4W3680	802400	41	553600	144
4W2975	802355	40	385610	144	4W3315	801900	25	231800	112	4W3685	802405	41	553610	144
4W2980	803455	38	473040	137	4W3320	801895	25	231700	112	4W3690			563163	110
4W2985	802840	33	585040	154	4W3325	802180	47	365600	154	4W3695			563172	111
4W2990	800020	18			4W3330	802185	48	365610	154	4W3700			455770	121
4W2995	802785	60	590040	152	4W3335	801700	19	280700	106	4W3705			455780	121
4W3000	802085	27	327612	120	4W3340	801705	19	280800	106	4W3710	802840	33	260300	125
4W3005	802080	27	327602	120	4W3345	801700	19	280500	105	4W3715			401840	115
4W3010	802780	58	575040	167	4W3350	801705	19	280600	106	4W3720			560830	116
4W3015	803775	42	490320	144	4W3355	801420	54	497680	180	4W3725			589300	111
4W3020	800140	72	420970	161	4W3360	801425	54	497690	180	4W3730			589310	111
4W3025	802905	48	327041	155	4W3365	802575	21	252300	99	4W3740	802740	45	497520	174
4W3030			373540	145	4W3370			500471	110	4W3745			374530	160
4W3035			373530	145	4W3375			500461	110	4W3750			374540	160
4W3040	801955	36	512171	138	4W3380	803570	49	478860	155	4W3755	801990	37	427180	136
4W3045	801960	36	512181	138	4W3385	802745	45	560520	174	4W3760	802590	28	243200	120
4W3050	801970	36	512180	138	4W3400	803425	23	283300	108	4W3775	800725	49	354260	156
4W3055	801965	36	512170	138	4W3410	800685	42	500870	145	4W3780			558530	147
4W3060	802730	49	565520	155	4W3415	800690	42	500880	146	4W3790	802595	28	243300	120
4W3065	800510	70	484921	178	4W3420	803415	23	283200	108	4W3795			290103	101
4W3070	803085	28	457852	121	4W3425			435700	121	4W3800			570780	104
4W3075	800010	18			4W3430			435710	121	4W3805			521660	130
4W3080	800005	18			4W3435	803025	52	384850	160	4W3810			521650	130
4W3085	801520	35	221500	133	4W3440	802180	47	492600	157	4W3815	801705	19	250600	98
4W3090	801525	35	221600	133	4W3445	802185	48	492610	157	4W3820	801700	19	250500	98
4W3095	802840	33	502040	154	4W3450	802935	30	386850	123	4W3825	801550	36	221300	132
4W3100	800275	68	503040	157	4W3455	802935	30	385850	123	4W3830	801555	36	221400	133
4W3105			501680	104	4W3465			332900	155	4W3835	803455	38	220600	132
4W3110			501690	104	4W3470			331520	155	4W3840	802440	37	427940	136
4W3115			282200	107	4W3475			331510	155	4W3850	801530	35	591080	139
4W3120			282300	107	4W3480			475490	103	4W3855	801535	36	591090	139
4W3125			290200	101	4W3485	802460	38	221100	132	4W3875			461400	183
4W3130			290300	102	4W3490	802465	38	221200	132	4W3895			369170	102
4W3135			348380	128	4W3495	803035	45	565852	169	4W3900	803350	63	320400	171
4W3140			348390	129	4W3500	802760	33	384040	129	4W3905	800840	63	390000	171
4W3145	800035	18			4W3505	802050	27	471601	122	4W3935	803070	34	231100	112
4W3150	800040	18			4W3515			459050	137	4W3940	800275	68	498040	184
4W3155	801700	19	250700	98	4W3520			399840	115	4W3950	803345	63	264850	171
4W3160	802725	49	567851	155	4W3525			399830	115	4W3955			578770	146
4W3165	803425	23	489521	109	4W3530	802975	55	514850	180	4W3960			578780	146
4W3170	801765	60	327850	152	4W3535	803320	49	310600	147	4W3965			436490	183



ABA
Automatic Brake Adjuster / Otomatik Fren Ayar Kolu.
S-ABA
(Self Setting) Automatic Brake Adjuster / Tam Otomatik Fren Ayar Kolu.

ALL ORIGINAL NUMBERS, MARKS AND MODELS FROM VEHICLE MANUFACTURERS LISTED IN THIS CATALOGUE ARE FOR COMPARISON PURPOSES ONLY AND MAY NOT BE USED IN INVOICES TO VEHICLE OWNERS OR RESELLERS / ORJINAL URÜN NUMARALARI MÜŞTERİYİ BİLGİLENDİRME VE ÜRÜNE REFERANS AMAÇLI KULLANILMIŞTIR.

* CS > Customer Specific / Özel İmalat

S-ABA / ABA Cross Reference List

S-ABA / ABA OEM Karşılaştırma Listesi



OEM NO	AYS S-ABA CODE	PAGE NO	AYS ABA CODE	PAGE NO	OEM NO	AYS S-ABA CODE	PAGE NO	AYS ABA CODE	PAGE NO	OEM NO	AYS S-ABA CODE	PAGE NO	AYS ABA CODE	PAGE NO
4W3970			436500	183	AAU3347	802215	58	335610	165	BBU9760	801860	24	230400	111
4W3975	801280	26	243400	120	AAU3348	802210	57	335600	164	BBU9761	801900	25	230800	112
4W3980	801285	26	243500	120	ACU3627			571710	167	BBU9763	802880	33	261100	125
4W3985	802540	20	254500	101	ACU3628			571720	167	BBU9767	802520	32	260101	124
4W3990	802545	21	254600	101	ACU3629	803100	59	360200	165	BBU9768			235400	113
4W4000	802330	61	481600	169	ACU6280	803195	59	342522	165	BBU9770			338971	173
4W4005	802335	61	481610	169	ACU6980	800585	57	536550	166	BBU9774	802905	48	260900	151
60506556B	800080	70	435803	176	ACU6981	800590	57	536560	166	BCU2077			571950	167
611484X	802905	48	260900	151	ACU7724	802780	58	575040	167	BCU5534			494710	166
611485X	802900	44	368040	154	ACU7725	802775	58	575041	167	BCU5535			494720	166
661465300611	802935	30	385850	123	ACU7738			574340	167	BCU5536			495220	166
661465300811	802935	30	386850	123	ACU7739			574330	167	BCU5767			385710	165
665465303211	801915	29	299170	123	ACU7740			391341	166	BCU5768			385720	166
665465303221	801920	29	299180	123	ACU7741			391331	166	BCU5769			386220	166
6969/F	800520	30	553560	130	ACU8342			391340	166	BFS010	800070	39	326862	169
6970/F	800515	30	553550	130	ACU8343			391330	166	BFS017	800060	64	470863	142
7000327W	800075	68	435800	174	ACU8344			391341	166	BFS018	803590	51	470861	183
72839G	801495	35	416090	136	ACU8345			391331	166	BFS029	800060	64	508900	173
72886G			418770	120	ACU8346	802780	58	575040	167	BMSAH	800060	64	508900	173
7684/F	802905	48	327041	155	ACU8347	802775	58	575041	167	CAL1984	803195	59	342520	165
7771/F	802180	47	492600	157	ACU8348	802895	58	575042	167	CAL2240			538660	167
7772/F	802185	48	492610	157	AJB0092001	800065	51	435802	158	CAL2241			538650	166
7950/F	803045	47	362850	156	AJB0742/A	800070	39	210030	139	CAL240			538660	167
7955/F	802190	27	362600	120	AJB0743001	800065	51	435802	158	CF230454	800610	64	437560	173
7956/F	802195	27	362610	120	AJB0743001	800065	51	435802	158	CF230455	800595	64	437550	173
80506556B	800080	70	435803	176	AJX9389	800060	64	508900	173	CF252122	800055	44	320234	148
805106556B	800065	51	435802	158	AMNB1213	800060	64	508900	173	CF350193	803170	64	468860	173
815061010174			500471	110	AMNS300654/D	800060	64	508900	173	CF350549	803170	64	534860	173
815061011175			500461	110	ARD1112833	801855	24	230300	111	CF3505492	803170	64	534860	173
815061012161			589300	111	ARG1112834	801860	24	230400	111	CF351039	803120	61	518520	169
815061013160			589310	111	ARJB0743701	800065	51	435802	158	CF3510393	803120	61	518520	169
815061014167	800875	22	282101	107	ARJB0743701	800065	51	435802	158	CF351148	803150	51	314525	157
815061015167	800875	22	282101	107	AS001	800060	64	508900	173	CF351530	800065	51	435802	158
815061017173			563570	111	ASY55481	802100	51	326600	182	CF351531	803635	65	398860	172
815061018176	800010	18	282800	107	ASY55482	802105	51	326610	182	CF351532	800070	39	326862	169
815061019177	800005	18	282900	107	ASZ07651	800065	51	435802	158	CF3515327	800070	39	326862	169
815061020178			283100	107	ASZ07652	800075	68	326863	157	CF351534	803655	51	326864	157
815061021179			283000	107	ASZ07653	803635	65	398860	172	CF351638	800060	64	470863	142
815061022180	803415	23	283200	108	ASZ07654	800060	64	470863	142	CF351820			359650	141
815061023180	803415	23	283200	108	AT72180	800885	49	330300	156	CF351827	800070	39	435300	141
815061024182	801705	19	280800	106	AT72181	800895	49	357263	156	CF351867	800060	64	470863	142
815061025181	801700	19	280700	106	AT72199	800885	49	330400	156	CF351902	800075	68	326863	157
815061026189			563162	110	AT72939	803735	50	563861	157	CF351972	803590	51	470861	183
815061027190			563171	110	AT79133	803740	50	563862	157	CF352122	800055	44	320234	148
815061028086			464150	109	AT79184	800890	49	330500	156	CF352203	800060	64	508900	173
815061029087			464140	108	AT79461	800905	49	276261	155	CF352234	800065	51	435802	158
815061030191			563163	110	AT79503			357630	182	CF352236	800060	64	508900	173
815061031192			563172	111	AT79504			357640	182	CF352279	800060	64	508900	173
815061032188	801630	22	280300	105	AVD1358634	801650	24	235830	113	CF352282	800070	39	210000	139
815061033187	801635	22	280400	105	AVG1358635	801655	24	235840	113	CF352283	800055	44	320134	148
815061034170			282200	107	B1003	801735	20	382770	103	CF352285	800065	51	435802	158
815061035169			282300	107	B1006	800005	18			CF352409	800060	64	508900	173
815061036101			572970	111	B1007	800010	18			CF352434	800070	39	210000	139
815061037101			572970	111	B1010	800030	18			CF352557	800060	64	508900	173
815061038091	800875	22	566260	111	B1011	801735	20	382770	103	CF352642	800060	64	361970	172
815061039091	800875	22	566260	111	B1015	801825	20	250900	98	CF35642	800060	64	361970	172
815061040183			281900	106	B1044	800785	26	240600	117	D50730120	800060	64	508900	173
815061041184			282000	107	B1203			359650	141	DAF46016	800755	26	240601	117
815061042194	803425	23	489521	109	B1206	800070	39	326862	169	DAF46035	801590	26	242600	119
815061043194	803425	23	489521	109	B1207	800060	64	508900	173	DAF46036	801595	26	242700	119
8947	803085	28	457852	121	B1208	800060	64	508900	173	E0070003	800060	64	508900	173
A06010603	800080	70	435803	176	B1214	800070	39	210000	139	E1013274	802765	47	311520	151
A3054202638	801560	19	250100	98	B1222			359650	141	E1013280	802755	47	311040	151
A3854201138	801800	20	251400	99	B510642			210900	153	E4424151042			424810	163
A3854201238	801795	20	251300	98	B510643			210800	152	E4424151043			424820	163
A4037350	803520	60	362521	169	BBU9750	801860	24	230400	111	E75701134	800615	42	578550	146
A4037351	800885	49	330300	156	BBU9758			235410	113	E75701137	800620	42	578560	146
A4037441	803505	59	362522	169	BBU9759	801855	24	230300	111	E984018	802840	33	585040	154

OEM NO	AYS S-ABA CODE	PAGE NO	AYS ABA CODE	PAGE NO	OEM NO	AYS S-ABA CODE	PAGE NO	AYS ABA CODE	PAGE NO	OEM NO	AYS S-ABA CODE	PAGE NO	AYS ABA CODE	PAGE NO
EAY537336	800065	51	435802	158	HB100047	800485	19	253400	100	KB2230	801525	35	220200	131
EN914264	803300	38	409850	171	HB100393	801955	36	512171	138	KB2235	800885	49	330300	156
EN914266	803300	38	409850	171	HB100394	801960	36	512181	138	KB2240	801520	35	220100	131
ES10889962			334710	164	HBU7280	802900	44	368040	154	KB2245	801515	35	220400	131
ES10889963			334720	164	HBV2315	800465	70	380000	177	KB2250	800790	23	230100	111
ES10901188			333220	164	KB1000	800060	64	508900	173	KB2255	800275	68	566040	130
ES10907244	802770	58	305040	164	KB1000D	800060	64			KB2260	801860	24	230400	111
ES10907245	802250	58	305600	164	KB1005	800055	44	320134	148	KB2265	802660	25	231500	112
ES10907246	802255	58	305610	164	KB1010	800055	44	320234	148	KB2270	802665	25	231600	112
ES8226963	802060	47	327600	151	KB1015	800080	70	435803	176	KB2275	802880	33	261100	125
ES8226964	802065	47	327610	151	KB1015D	800080	70			KB2280	802525	32	260201	125
ES8228242	802905	48	260900	151	KB1020	800065	51	435802	158	KB2285	802495	32	260200	125
ES8228243	802900	44	368040	154	KB1020D	800065	51			KB2290	802490	32	260100	124
ES8550578	802915	28	502041	154	KB1022	800065	51	435802	158	KB2295	802980	34	261200	125
ES8550903	802840	33	585040	154	KB1025	800075	68	435800	174	KB2300	802520	32	260101	124
ES8550963	802830	48	365040	154	KB1025D	800075	68			KB2305	800785	26	240600	117
ESACU3627			571710	167	KB1030	803620		470862	142	KB2310	802060	47	327600	151
ESACU3628			571720	167	KB1035	803210	40	492520	142	KB2315	803100	59	360200	165
ESACU3629	803100	59	360200	165	KB1040	800060	64	470863	142	KB2320			334710	164
ESACU6980	800585	57	536550	166	KB1065	803170	64	468860	173	KB2325	802905	48	260900	151
ESACU6981	800590	57	536560	166	KB1075	800070	39	435300	141	KB2330			333220	164
ESBCU5534			494710	166	KB1080			359650	141	KB2335	800565	57	325550	164
ESBCU5535			494720	166	KB1095	800070	39	210030	139	KB2340			386220	166
ESBCU5536			495220	166	KB1105	800055	44	326320	149	KB2345			385710	165
ESBCU5767			385710	165	KB1110			366640	141	KB2350			385720	166
ESBCU5768			385720	166	KB1115	802300	39	322601	140	KB2360			235400	113
ESBCU5769			386220	166	KB1120	802305	39	322611	140	KB2370	803095	59	360100	165
ESBUU5769			386220	166	KB2010	802050	27	242001	118	KB2375	802830	48	365040	154
ESCAL2240			538660	167	KB2015	802055	27	242101	118	KB2380			391340	166
ESCAL2241			538650	166	KB2020	801590	26	242600	119	KB2385			391330	166
ESXBU1001	801860	24	230400	111	KB2025	801595	26	242700	119	KB2390	800570	57	325560	164
ESXBU1005	801855	24	230300	111	KB2030	802920	28	241100	117	KB2395			461650	122
ESXBU1009	802660	25	231500	112	KB2035	802640	28	242201	118	KB2400			455650	121
ESXBU1010			235400	113	KB2040	802575	21	251900	99	KB2420	802575	21	251700	99
ESXBU1012			235410	113	KB2045	801740	20	251800	99	KB2425			455660	121
ESXBU1019	802785	60	590040	152	KB2050	800020	18			KB2430	803175	59	325520	164
ESXBU1020	802185	48	365610	154	KB2055	800015	18			KB2435			334720	164
ESXBU1021	802180	47	365600	154	KB2060	800010	18			KB2440	801560	19	250100	98
ESXBU1024			283100	107	KB2065	800005	18			KB2445	801720	20	283700	101
ESXBU1027			210804	177	KB2070	801805	23	281500	106	KB2450	802600	33	261700	126
ESXBU1028			210902	177	KB2075	801810	23	281600	106	KB2455	802605	33	261710	126
ESXBU1030			282300	107	KB2080	801735	20	281400	106	KB2470	801795	20	251300	98
ESXBU1032			283000	107	KB2085	803775	42	210200	143	KB2475			571710	167
ESXBU1033			282200	107	KB2090	801725	20	281000	106	KB2480			571720	167
F4003/F	802240	45	471600	150	KB2095	801720	20	280900	106	KB2495	800585	57	536550	166
F4004/F	802245	45	471610	150	KB2100	801850	20	250200	98	KB2500	800590	57	536560	166
F4105/F	802060	47	327600	151	KB2105	802645	28	242301	119	KB2515	800755	26	243000	119
F4106/F	802065	47	327610	151	KB2110	802595	28	242300	119	KB2520	801895	25	231700	112
F4127/F	802830	48	365040	154	KB2115	802050	27	241800	118	KB2525	801900	25	231800	112
F4211/F	803045	47	362850	156	KB2120	802590	28	242200	118	KB2530	802615	33	261400	126
F4238/F	802180	47	492600	157	KB2125	802055	27	241900	118	KB2535	802610	33	261300	125
F4239/F	802185	48	492610	157	KB2130	801570	19	252000	99	KB2540	802625	33	261401	126
F4240/F	802905	48	327041	155	KB2135	800030	18			KB2545	802620	33	261301	125
F4348/F	802900	44	369040	175	KB2140	800025	18			KB2550			302650	127
F4419/F	802900	44	365041	154	KB2145	800020	18			KB2555			302540	126
F4706/F	802160	52	247600	160	KB2150	801735	20	382770	103	KB2560			302530	126
F4707/F	802165	52	247610	160	KB2155	801830	20	251000	98	KB2565			520530	130
F4714/F	802180	47	365600	154	KB2160	801825	20	250900	98	KB2570			520540	130
F4715/F	802185	48	365610	154	KB2165	800015	18			KB2575			302661	127
F9141/F			370100	152	KB2170	800895	49	357263	156	KB2580			302651	127
FC9327002	803165	51	400100	173	KB2175	800885	49	330400	156	KB2585			390710	114
FC9327004	802840	33	502040	154	KB2180	802775	58	575041	167	KB2590			390720	114
FL932/002	803165	51	400100	173	KB2185			391341	166	KB2595			235410	113
FL932/004	802840	33	502040	154	KB2190			391331	166	KB2600	800460	23	405510	115
FL932/005	802915	28	314526	155	KB2210	801895	25	230700	112	KB2605	800455	23	405500	115
FL932005	802915	28	314526	155	KB2215	801900	25	230800	112	KB2610	800010	18	282800	107
G79097CR	800595	64	437550	173	KB2220	801855	24	230300	111	KB2615	800005	18	282900	107
HB100046	800490	19	253500	100	KB2225	801510	35	220301	131	KB2620	801630	22	280300	105



S-ABA / ABA Cross Reference List

S-ABA / ABA OEM Karşılaştırma Listesi



OEM NO	AYS S-ABA CODE	PAGE NO	AYS ABA CODE	PAGE NO	OEM NO	AYS S-ABA CODE	PAGE NO	AYS ABA CODE	PAGE NO	OEM NO	AYS S-ABA CODE	PAGE NO	AYS ABA CODE	PAGE NO
KB2625	801635	22	280400	105	MAN60003	801805	23	281500	106	S5005111	800760	45	374261	179
KB2630	801985	36	433170	136	MAN60004	801810	23	281600	106	SCA64502	801855	24	230300	111
KB2635	801990	37	433180	136	MAN6001	801630	22	280300	105	SCA64506	800790	23	230100	111
KB2640	802430	37	220902	132	MAN60501	801635	22	280400	105	SK5086	800070	39	210000	139
KB2645	802435	37	221002	132	MAN60502			500471	110	SPK/1262B	801955	36	512171	138
KB2650	802770	58	305040	164	MAS9249	800060	64	508900	173	T0017649Z	800080	70	435803	176
KB2655	802250	58	305600	164	MAS9250	802300	39	322601	140	TC807634	801080	69	270100	176
KB2660			312660	128	MAS9251	802305	39	322611	140	TC807635	801085	69	270200	176
KB2665			312650	128	MAS9280	800595	64	437550	173	TP02003001X	800060	64	508900	173
KB2670	802895	58	575042	167	MAS9281	800610	64	437560	173	TP02003003X	800595	64	437550	173
KB2675	800780	26	241500	118	MAS9285	802310	68	437600	175	TP02003004X	800610	64	437560	173
KB2680	801900	25	230800	112	MAS9286	802315	68	437610	175	TP02003005X	800060	64	508900	173
KB2685			302662	127	MAS9287	803640	65	437860	173	TP02003006X	800070	39	326862	169
KB2690			302652	127	MAS9289	800070	39	361760	129	TP02003007X	800065	51	435802	158
KB2695			302660	127	MAS9290	800060	64	361970	172	TP02003008X	800070	39	210000	139
KB2700	802065	47	327610	151	MER62043	800005	18			TP02003009X	800070	39	210000	139
KB2705	802990	34	583850	131	MER62044	800010	18			TP02003059X	800060	64		
KB2710	803070	34	231100	112	MR23565701	800075	68	435800	174	X1811183	802060	47	327600	151
KB2715			377350	102	NB1200	800070	39	432970	183	X1811184	802065	47	327610	151
KB2720			377360	103	NB1213	800060	64	508900	173	X2052967	802785	60	590040	152
KB2735	801650	24	235830	113	NB3000654/D	800060	64	508900	173	X2210966	801770	60	327860	152
KB2740	801655	24	235840	113	NB300654/D	800060	64	508900	173	X2210967	801765	60	327850	152
KB2755			487050	104	NRK3115			245950	163	XBU1001	801860	24	230400	111
KB2760	800755	26	240601	117	NRK3116			245940	163	XBU1009	802660	25	231500	112
KB2765	801725	20	250400	98	NRK3117	803100	59	343520	165	XBU1010			235400	113
KB2785	800465	70	380000	177	NRK3550	802985	58	569850	167	XBU1012			235410	113
KB2790	800470	70	380100	177	NS300325	800070	39	210000	139	XH12132C	800885	49	431260	157
KB2795	802445	37	221000	132	NS300654/D	800060	64	508900	173	XH70627X			334720	164
KB2800	802440	37	220900	132	P17179028	802310	68	437600	175	XH7062RX			333220	164
KB2815	801540	36	581080	139	P17179029	802315	68	437610	175	XH72180/C	800885	49	330300	156
KB2820	801545	36	581090	139	P17179051	803640	65	437860	173	XH72181/C	800895	49	357263	156
KB2825	802900	44	368040	154	P17179097	800595	64	437550	173	XH72199/C	800885	49	330400	156
KB2830	801830	20	254100	101	P17179098	800610	64	437560	173	XH72939/C	803735	50	563861	157
KB2835	803090	58	360000	165	P17179183	800060	64	361970	172	XH79133/C	803740	50	563862	157
KB2840	801800	20	251400	99	R2111/F			247530	151	XH79184/C	800890	49	330500	156
KB2850	801895	25	230700	112	R2112/F			247540	151	Y03277102	802905	48	327041	155
KB2855	800015	18			R8270/F	802060	47	327600	151	Y03280904	802180	47	492600	157
KB2865	802915	28	310040	153	R8271/F	802065	47	327610	151	Y10538610	800060	64	508900	173
KB2870	802005	37	479170	137	R8538/F	802900	44	368040	154	Y537146	803655	51	326864	157
KB2875	802010	37	479180	137	R8610/F	802785	60	590040	152	Y730111	801235	77	566690	184
KB2880	802930	28	241201	117	R8744/F	802060	47	587600	152	Y730118	800070	39	326862	169
KB2885	802915	28	583041	131	R8745/F	802065	47	587610	152					
KB2890			538660	167	R8819/F	802900	44	361520	179					
KB2895			538650	166	R8849/F	801770	60	327860	152					
KB2900			319540	128	R8850/F	801765	60	327850	152					
KB2905	802465	38	220800	132	R8918/F	802210	57	327601	152					
KB2910	802460	38	220700	132	R8919/F	802215	58	327611	152					
KB2915	803300	38	409850	171	R9024/F	802045	47	357610	153					
KB2920	801985	36	496170	137	R9025/F	802040	47	357600	153					
KB2925	801990	37	496180	137	R9139/F			370000	152					
KB2930	801705	19	250800	98	R9567/F	802905	48	590041	184					
KB2940	801490	35	416080	136	R9640/F	802080	27	327602	120					
KB2945	801495	35	416090	136	R9641/F	802085	27	327612	120					
L1850087			282200	107	R9813/F	803045	47	506850	184					
L1850096			282300	107	R9990/F	801200	47	492680	154					
L2220055	800900	62	508261	170	R9991/F	801205	47	492690	154					
LL0095	802300	39	322601	140	RVI44035	801540	36	581080	139					
LL0096	802305	39	322611	140	RVI44036	801545	36	581090	139					
M002416	800075	68	435800	174	RVI44058	801525	35	220200	131					
M023565	800075	68	435800	174	RVI44059	801525	35	220200	131					
M042128	800060	64	508900	173	RVI44077			302570	134					
M046514	800070	39	210030	139	RVI44078			318530	135					
M050082	800075	68	435800	174	RVI44090	801510	35	220301	131					
M068593	800080	70	435803	176	RVI44091	801515	35	220400	131					
M070970	800060	64	508900	173	RVI44092	802445	37	221000	132					
M071101	800060	64	508900	173	RVI44093	802440	37	220900	132					
M094527	800060	64	508900	173	S5001048	802745	45	560520	174					
MAN60001	801630	22	280300	105	S5004035	802740	45	497520	174					

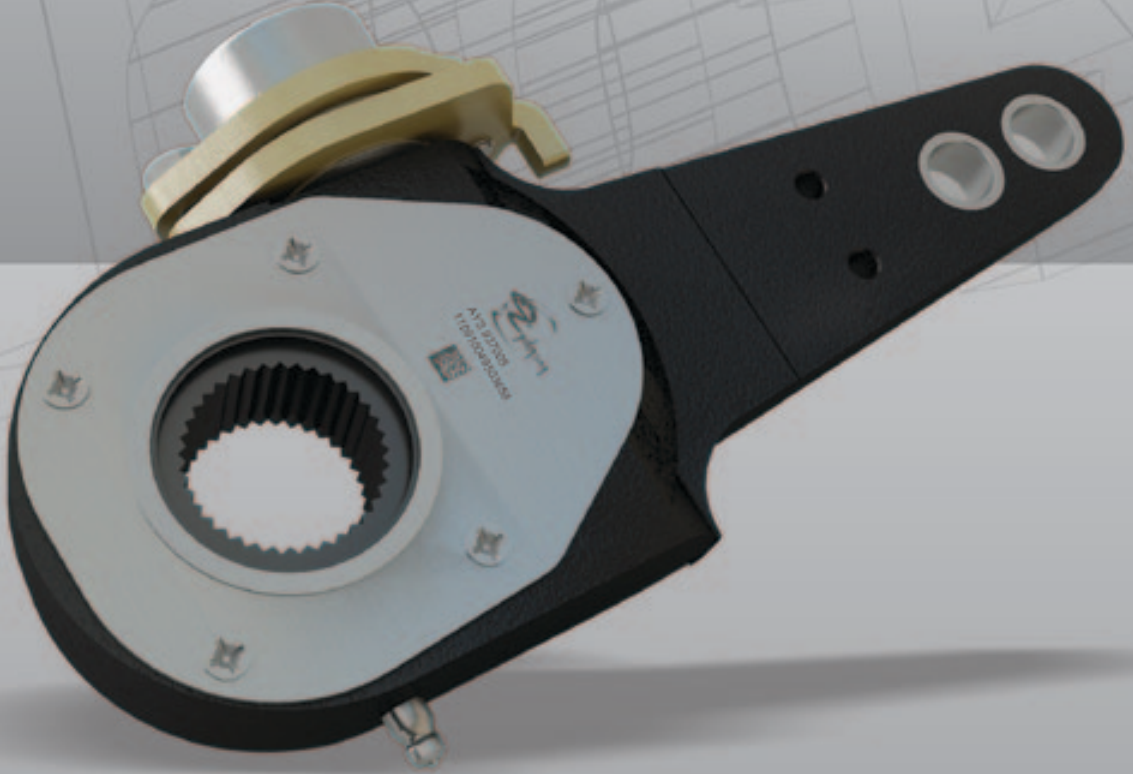

32 U-Lock Automatic Brake Adjuster

32'lik U Kilitli Otomatik Fren Ayar Kolları

32 U-Lock Automatic Brake Adjuster

32'lik U Kilitli Otomatik Fren Ayar Kolları

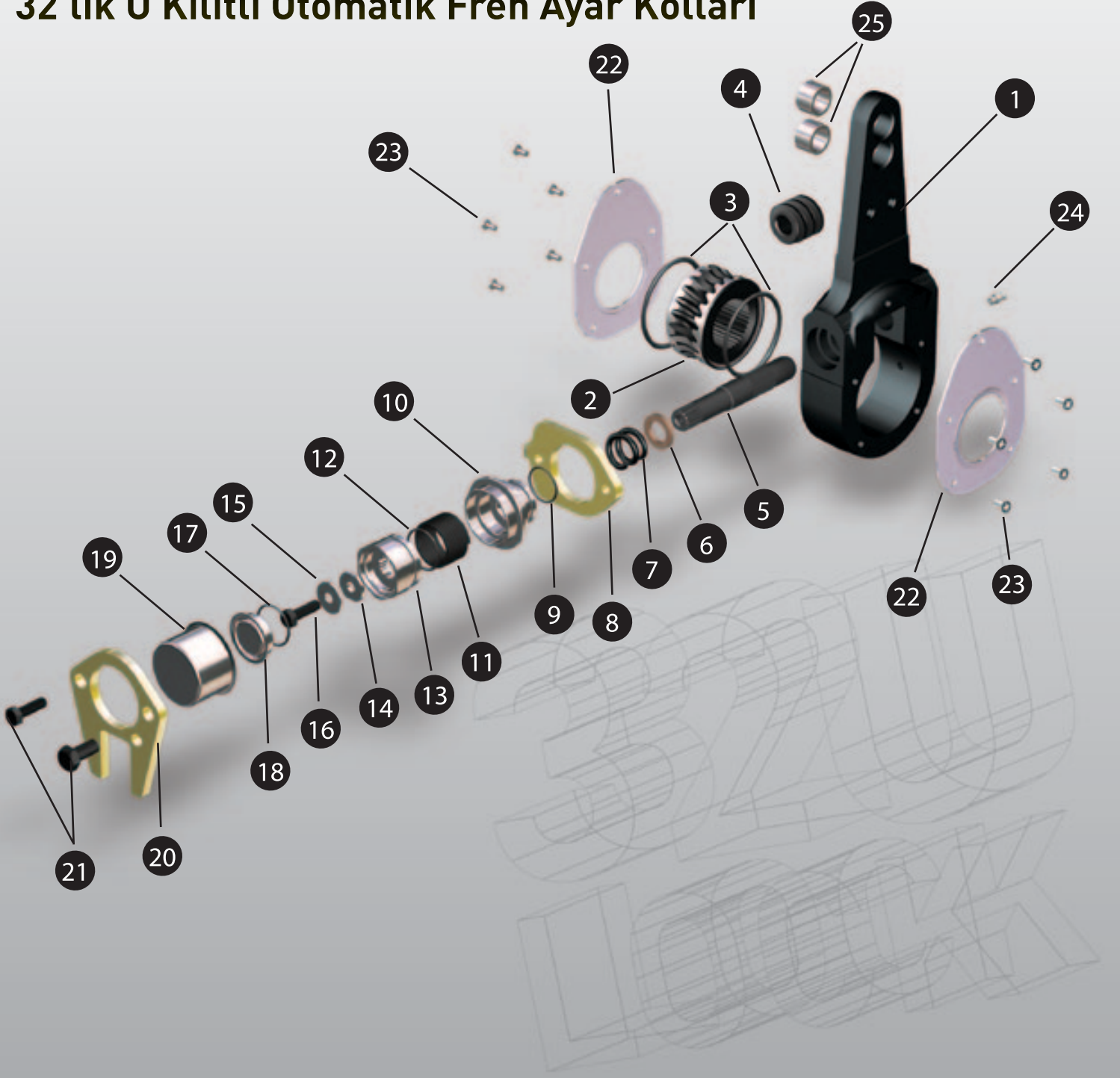

32U-LockAutomatic Brake Adjuster

32'lik U Kilitli Otomatik Fren Ayar Kollu



PART LIST PARÇA LİSTESİ

1. Body / Gövde
2. Warm gear / Sonsuz dişli
3. O-ring / Oring
4. Warm screw/ Sonsuz vida
5. Rod / Mil
6. Compression washer / Baskı pulu
7. Compression spring / Baskı yayı
8. Clutch lock-lower / Kavrama kilidi alt
9. O-ring / Oring
10. Clutch housing-lower / Kavrama kovani alt
11. Clutch spring / Kavrama yay
12. O-ring / Oring
13. Clutch housing-upper / Kavrama kovani-üst
14. Washer / Kesik pul
15. Lock washer / Kilit pulu
16. M6 screw / M6 vida
17. O-ring / Oring
18. Plug / Tapa
19. Dust cover / Toz kapağı
20. Clutch lock-upper / Kavrama kilidi-üst (U-Lock)
21. M8 screw / M8 vida
22. Cover plate / Kapak sacı
23. Screw / Vida
24. Grease nipple / Grasörlük
25. Bush / Burç

32 U-Lock Automatic Brake Adjuster

In respect to customer requests, in addition to automatic brake adjusters which are being produced for long years, 32 U-lock automatic brake adjuster was improved and submitted to market. Thus our customers requests have been met.

32'lik U Kilitli Otomatik Fren Ayar Kolu

Müşteri talepleri doğrultusunda yıllardan beri üretilmekte olan otomatik fren ayar kollarına ilave olarak, 32'lik U kilit tipi otomatik fren ayar kolunu geliştirilerek, bu tip fren ayar kolu kullanan müşterilerimizin talepleri de karşılanmıştır.

Description for 32 U-Lock Automatic Brake Adjuster

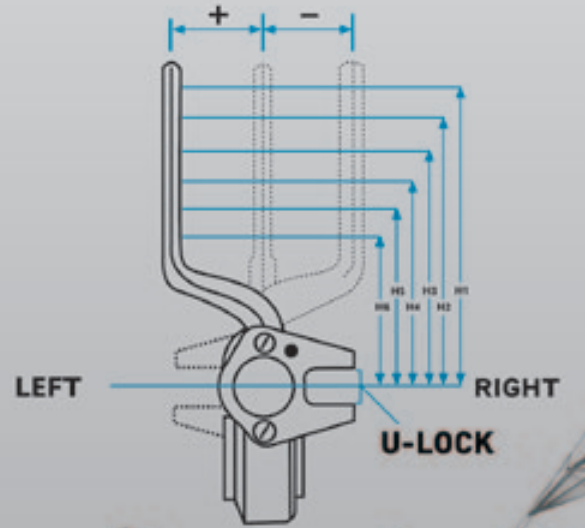

TECHNICAL LIST

AYS CODE	CASTING	APPLICATION	NO OF SPLINE TEETH	NO of HOLE	H1	H2	H3	H4	H5	H6	BUSHING (mm)	U-Lock	SPLINE TYPE	SIDE OF MOUNTING
908000	9033	VAN HOOL	8	1	170						Ø12,7	22	A 8x32 DIN 5463	right
908001	9033	VAN HOOL	8	1	170						Ø12,7	22	A 8x32 DIN 5463	left
908002	9049	VAN HOOL	8	1	152						Ø12,7	22	A 8x32 DIN 5463	right
908003	9049	VAN HOOL	8	1	152						Ø12,7	22	A 8x32 DIN 5463	left
908004	9057	VAN HOOL	8	1	250	180					Ø12,7	22	A 8x32 DIN 5463	right
908005	9057	VAN HOOL	8	1	250	180					Ø12,7	22	A 8x32 DIN 5463	left
910001	9000	BPW	10	3	180	150	120				Ø14	28	1.5 " -10C SAE	right
910002	9000	BPW	10	3	180	150	120				Ø14	28	1.5 " -10C SAE	left
910003	9000	BPW	10	3	180	150	120				Ø14	20	1.5 " -10C SAE	right
910004	9000	BPW	10	3	180	150	120				Ø14	20	1.5 " -10C SAE	left
910005	9000	NEOPLAN	10	1	140						Ø12,7	30	1.5 " -10C SAE	right
910006	9000	NEOPLAN	10	1	140						Ø12,7	30	1.5 " -10C SAE	left
910007	9002	BPW	10	4	290	260	240	175			Ø14	20	1.5 " -10C SAE	right
910008	9002	BPW	10	4	290	260	240	175			Ø14	20	1.5 " -10C SAE	left
910009	9002	BPW	10	4	250	180	150	120			Ø14	30	1.5 " -10C SAE	right
910010	9002	BPW	10	4	250	180	150	120			Ø14	30	1.5 " -10C SAE	left
910011	9002	BPW	10	4	203,2	177	152	127			Ø14	30	1.5 " -10C SAE	right
910012	9002	BPW	10	4	203,2	177	152	127			Ø14	30	1.5 " -10C SAE	left
910013	9000	BPW	10	3	180	150	120				Ø14	30	1.5 " -10C SAE	right
910014	9000	BPW	10	3	180	150	120				Ø14	30	1.5 " -10C SAE	left
910015	9000	BPW	10	1	150						Ø14	30	1.5 " -10C SAE	right
910016	9000	BPW	10	1	150						Ø14	30	1.5 " -10C SAE	left
910017	9000	BPW	10	3	180	150	120				Ø14	30	1.5 " -10C SAE	right
910018	9000	BPW	10	3	180	150	120				Ø14	30	1.5 " -10C SAE	left
910019	9009	MAN	10	1	178						Ø12,7	22	1.5 " -10C SAE	right
910020	9009	MAN	10	1	178						Ø12,7	22	1.5 " -10C SAE	left
910021	9000	BPW	10	1	165						Ø15,9	24	1.5 " -10C SAE	right
910022	9000	BPW	10	1	165						Ø15,9	24	1.5 " -10C SAE	left
910023	9002	BPW	10	4	230	180	150	120			Ø14	30	1.5 " -10C SAE	right
910024	9002	BPW	10	4	230	180	150	120			Ø14	30	1.5 " -10C SAE	left
910025	9000	DAF	10	1	140						Ø14	30	1.5 " -10C SAE	right
910026	9000	DAF	10	1	140						Ø14	30	1.5 " -10C SAE	left
910027	9002	BPW	10	5	203,2	177,8	152,4	127	104		Ø14	30	1.5 " -10C SAE	right
910028	9002	BPW	10	5	203,2	177,8	152,4	127	104		Ø14	30	1.5 " -10C SAE	left
910029	9014	DAF	10	1	140						Ø14	30	1.5 " -10C SAE	right
910030	9014	DAF	10	1	140						Ø14	30	1.5 " -10C SAE	left
910031	9012	DAF	10	1	140						Ø14	30	1.5 " -10C SAE	right
910032	9012	DAF	10	1	140						Ø14	30	1.5 " -10C SAE	left
910033	9014	DAF	10	1	140						Ø22	30	1.5 " -10C SAE	right
910034	9014	DAF	10	1	140						Ø22	30	1.5 " -10C SAE	left
910035	9000	DAF	10	1	140						Ø12,7	24	1.5 " -10C SAE	right
910036	9000	DAF	10	1	140						Ø12,7	24	1.5 " -10C SAE	left
910037	9002	BPW	10	3	273	243	213				Ø14	28	1.5 " -10C SAE	right
910038	9002	BPW	10	3	273	243	213				Ø14	28	1.5 " -10C SAE	left
910039	9049	BPW	10	1	160						Ø14	22	1.5 " -10C SAE	right
910040	9049	BPW	10	1	160						Ø14	22	1.5 " -10C SAE	left
910041	9045	BPW	10	3	182	165	148				Ø14	30	1.5 " -10C SAE	right
910042	9045	BPW	10	3	182	165	148				Ø14	30	1.5 " -10C SAE	left
910043	9045	BPW	10	3	182	165	148				Ø14	30	1.5 " -10C SAE	right
910044	9045	BPW	10	3	182	165	148				Ø14	30	1.5 " -10C SAE	left
910045	9031	BPW	10	1	165						Ø12,7	22	1.5 " -10C SAE	right
910046	9031	BPW	10	1	165						Ø12,7	22	1.5 " -10C SAE	left

TECHNICAL LIST

AYS CODE	CASTING	APPLICATION	NO OF SPLINE TEETH	NO OF HOLE	H1	H2	H3	H4	H5	H6	BUSHING (mm)	U-Lock	SPLINE TYPE	SIDE OF MOUNTING
910047	9075	BPW	10	2	180	150					Ø14	20	1.5 " -10C SAE	right
910048	9075	BPW	10	2	180	150					Ø14	20	1.5 " -10C SAE	left
910049	9045	BPW	10	4	203,2	177	152	127			Ø14	30	1.5 " -10C SAE	right
910050	9045	BPW	10	4	203,2	177	152	127			Ø14	30	1.5 " -10C SAE	left
910051	9079	BPW	10	2	180	150					Ø14	22	1.5 " -10C SAE	right
910052	9079	BPW	10	2	180	150					Ø14	22	1.5 " -10C SAE	left
910053	9045	BPW	10	4	203,2	177	152	127			Ø14	30	1.5 " -10C SAE	right
910054	9045	BPW	10	4	203,2	177	152	127			Ø14	30	1.5 " -10C SAE	left
910055	9057	DAF	10	1	140						Ø14	30	1.5 " -10C SAE	right
910056	9057	DAF	10	1	140						Ø14	30	1.5 " -10C SAE	left
910057	9055	DAF	10	1	168.3							30	1.5 " -10C SAE	right
910058	9055	DAF	10	1	168.3							30	1.5 " -10C SAE	left
910059	9057	DAF	10	1	140						Ø14	30	1.5 " -10C SAE	right
910060	9057	DAF	10	1	140						Ø14	30	1.5 " -10C SAE	left
910061	9019	BPW	10	1	127						Ø12,7	24	1.5 " -10C SAE	right
910062	9019	BPW	10	1	127						Ø12,7	24	1.5 " -10C SAE	left
910065	9019	BPW	10	1	127						Ø14	24	1.5 " -10C SAE	right
910066	9019	BPW	10	1	127						Ø14	24	1.5 " -10C SAE	left
910067	9023	BPW	10	4	290	260	230	175			x:Ø14 (H4:Ø22)	30	1.5 " -10C SAE	right
910068	9023	BPW	10	4	290	260	230	175			x:Ø14 (H4:Ø22)	30	1.5 " -10C SAE	left
910069	9024	BPW	10	4	290	260	230	175			x:Ø14 (H4:Ø22)	30	1.5 " -10C SAE	right
910070	9025	BPW	10	4	290	260	230	175			x:Ø14 (H4:Ø22)	30	1.5 " -10C SAE	left
910071	9022	BPW	10	3	220	190	165				Ø14	30	1.5 " -10C SAE	right
910072	9022	BPW	10	3	220	190	165				Ø14	30	1.5 " -10C SAE	left
910073	9023	BPW	10	3	220	190	165				Ø14	30	1.5 " -10C SAE	right
910074	9083	IKARUS-FRONT RIGHT	10	1	180						12,7	26	1.5 " -10C SAE	right
910075	9083	IKARUS-FRONT LEFT	10	1	180						12,7	26	1.5 " -10C SAE	left
919000	9000	BPW	19	1	120						Ø14	24	A 38x34 H 10 DIN 5482	right
919001	9000	BPW	19	1	120						Ø14	24	A 38x34 H 10 DIN 5482	left
919002	9000	NEOPLAN	19	1	145						Ø14	24	A 38x34 H 10 DIN 5482	left
919003	9000	NEOPLAN	19	1	145						Ø14	24	A 38x34 H 10 DIN 5482	right
919004	9000	MERCEDES	19	1	145						Ø14	22	A 38x34 H 10 DIN 5482	right
919005	9000	MERCEDES	19	1	145						Ø14	22	A 38x34 H 10 DIN 5482	left
919006	9049	EVO-BUS	19	1	170						Ø14	24	A 38x34 H 10 DIN 5482	right
919007	9049	EVO-BUS	19	1	170						Ø14	24	A 38x34 H 10 DIN 5482	left
919008	9049	BPW	19	1	160						Ø14	24	A 38x34 H 10 DIN 5482	right
919009	9049	BPW	19	1	160						Ø14	24	A 38x34 H 10 DIN 5482	left
919010	9049	DAF	19	1	175						Ø14	24	A 38x34 H 10 DIN 5482	right
919011	9049	DAF	19	1	175						Ø14	24	A 38x34 H 10 DIN 5482	left
919012	9049	BPW	19	1	175						Ø14	24	A 38x34 H 10 DIN 5482	right
919013	9049	BPW	19	1	175						Ø14	24	A 38x34 H 10 DIN 5482	left
919014	9049	BPW	19	1	160						Ø14	24	A 38x34 H 10 DIN 5482	right
919015	9049	BPW	19	1	160						Ø14	24	A 38x34 H 10 DIN 5482	left
919016	9063	BPW	19	1	175						Ø14	24	A 38x34 H 10 DIN 5482	right
919017	9063	BPW	19	1	175						Ø14	24	A 38x34 H 10 DIN 5482	left
919018	9083	BPW	19	1	175						Ø14	24	A 38x34 H 10 DIN 5482	right
919019	9083	BPW	19	1	175						Ø14	24	A 38x34 H 10 DIN 5482	left
919100	9000	BPW	19	1	160						Ø14	20	A38x34 DIN 5482	right
919101	9000	BPW	19	1	160						Ø14	20	A38x34 DIN 5482	left
919102	9000	BPW	19	1	180						Ø14	28	A38x34 DIN 5482	left
919103	9000	EVO-BUS	19	1	120						Ø14	24	A38x34 DIN 5482	right



TECHNICAL LIST

AYS CODE	CASTING	APPLICATION	NO OF SPLINE TEETH	NO of HOLE	H1	H2	H3	H4	H5	H6	BUSHING (mm)	U-Lock	SPLINE TYPE	SIDE OF MOUNTING
919104	9000	EVO-BUS	19	1	120						Ø14	24	A38x34 DIN 5482	left
919107	9002	BPW	19	1	200						Ø14	20	A38x34 DIN 5482	right
919108	9002	BPW	19	1	200						Ø26	20	A38x34 DIN 5482	left
919109	9000	BPW	19	1	145						Ø14	24	A38x34 DIN 5482	right
919110	9000	BPW	19	1	145						Ø14	24	A38x34 DIN 5482	Left
919111	9000	STEYR	19	1	122						Ø14	32	A38x34 DIN 5482	right
919112	9000	STEYR	19	1	122						Ø14	32	A38x34 DIN 5482	left
919115	9000	MAN	19	1	145						Ø14	26	A38x34 DIN 5482	right
919116	9000	STEYR	19	1	130						Ø14	35	A38x34 DIN 5482	right
919117	9000	STEYR	19	1	130						Ø14	35	A38x34 DIN 5482	left
919118	9006	BPW	19	1	145						Ø14	24	A38x34 DIN 5482	right
919119	9004	BPW	19	1	125						Ø12	24	A38x34 DIN 5482	right
919120	9004	BPW	19	1	125						Ø12	24	A38x34 DIN 5482	left
919121	9015	MERCEDES	19	1	110						Ø14	24	A38x34 DIN 5482	right
919122	9015	MERCEDES	19	1	110						Ø14	24	A38x34 DIN 5482	left
919123	9015	BPW	19	1	105						Ø14	24	A38x34 DIN 5482	right
919124	9015	BPW	19	1	105						Ø14	24	A38x34 DIN 5482	left
919125	9085	MERCEDES	19	2	176	92					H1:Ø14 (H2:Ø12)	24	A38x34 DIN 5482	right
919126	9085	MERCEDES	19	2	176	92					H1:Ø14 (H2:Ø12)	24	A38x34 DIN 5482	left
919127	9049	EVO-BUS	19	1	170						Ø14	24	A38x34 DIN 5482	right
919128	9049	EVO-BUS	19	1	170						Ø14	24	A38x34 DIN 5482	left
919129	9072	STEYR	19	1	145						Ø14	24	A38x34 DIN 5482	right
919130	9071	STEYR	19	1	145						Ø14	24	A38x34 DIN 5482	left
919131	9049	BPW	19	1	160						Ø14	24	A38x34 DIN 5482	right
919132	9049	BPW	19	1	160						Ø14	24	A38x34 DIN 5482	left
919133	9085	MERCEDES	19	2	176	92					H1:Ø12 (H2:Ø14)	24	A38x34 DIN 5482	right
919134	9085	MERCEDES	19	2	176	92					H1:Ø12 (H2:Ø14)	24	A38x34 DIN 5482	left
919135	9049	BPW	19	1	160						Ø14	24	A38x34 DIN 5482	right
919136	9049	BPW	19	1	160						Ø14	24	A38x34 DIN 5482	left
919137	9057	STEYR	19	1	130						Ø14	28	A38x34 DIN 5482	right
919138	9057	STEYR	19	1	130						Ø14	28	A38x34 DIN 5482	left
919139	9037		19	1	145						Ø14	22	A38x34 DIN 5482	right
919140	9037		19	1	145						Ø14	22	A38x34 DIN 5482	left
920000	9090	MAN	20	2	215	140					H1:Ø14 (H2:x,Ø8)	28	A 40x36 DIN 5482	right
920001	9090	MAN	20	2	215	140					H1:Ø14 (H2:x,Ø8)	28	A 40x36 DIN 5482	left
920002	9090	MAN	20	2	190	140					H1:Ø14 (H2:Ø8)	28	A 40x36 DIN 5482	right
920100	9002	BPW	20	1	215	140					Ø14 (H2:x,Ø8)	28	A 40x36 DIN 5482	right
920101	9002	BPW	20	1	215	140					Ø14 (H2:x,Ø8)	28	A 40x36 DIN 5482	left
920102	9000	BPW	20	1	135						Ø14	24	A 40x36 DIN 5482	right
920103	9000	BPW	20	1	135						Ø14	24	A 40x36 DIN 5482	Left
920104	9000	BPW	20	1	180								A 40x36 DIN 5482	right
920105	9000	BPW	20	1	180								A 40x36 DIN 5482	left
920106	9000	BPW	20	1	175								A 40x36 DIN 5482	right
920107	9000	BPW	20	1	175								A 40x36 DIN 5482	left
920108	9000	BPW	20	1	155						Ø14	24	A 40x36 DIN 5482	right
920109	9000	BPW	20	1	155						Ø14	24	A 40x36 DIN 5482	left
920110	9049	COBRA	20	3	140	170	170				(x,Ø8) L1:Ø14	24	A 40x36 DIN 5482	right
920111	9049	COBRA	20	3	140	170	170				(x,Ø8) L1:Ø14	24	A 40x36 DIN 5482	left
920112	9000	COBRA-FRONT RIGHT	20	1	130						Ø14	24	A 40x36 DIN 5482	right
920113	9000	COBRA-FRONT LEFT	20	1	130						Ø14	24	A 40x36 DIN 5482	left
920114	9000	IKARUS-REAR RIGHT	20	3	175	120	120				(x,Ø6,5) L1:Ø14	26	A 40x36 DIN 5482	right
920115	9000	IKARUS-REAR LEFT	20	3	175	120	120				(x,Ø6,5) L1:Ø14	26	A 40x36 DIN 5482	left

32 U Lock Automatic Brake Adjuster

32'lik U Kilitti Otomatik Fren Ayar Kolları

TECHNICAL LIST

AYS CODE	CASTING	APPLICATION	NO OF SPLINE TEETH	NO OF HOLE	H1	H2	H3	H4	H5	H6	BUSHING (mm)	U-Lock	SPLINE TYPE	SIDE OF MOUNTING
926000	9000	DAF	26	1	140						x,Ø22	30	N 42x1,5x26x9 H DIN 5480	right
926001	9000	DAF	26	1	140						x,Ø22	30	N 42x1,5x26x9 H DIN 5480	left
926002	9013	BPW	26	1	130						Ø14	24	N 42x1,5x26x9 H DIN 5480	right
926003	9013	BPW	26	1	130						Ø14	24	N 42x1,5x26x9 H DIN 5480	left
926004	9000	BPW	26	1	115						Ø14	24	N 42x1,5x26x9 H DIN 5480	right
926005	9011	MERCEDES	26	1	145						Ø14	24	N 42x1,5x26x9 H DIN 5480	right
926006	9011	MERCEDES	26	1	145						Ø14	24	N 42x1,5x26x9 H DIN 5480	left
926007	9010	MERCEDES	26	1	110						Ø14	24	N 42x1,5x26x9 H DIN 5480	right
926008	9010	MERCEDES	26	1	110						Ø14	24	N 42x1,5x26x9 H DIN 5480	left
926009	9005	BPW	26	1	145						Ø14	24	N 42x1,5x26x9 H DIN 5480	
926010	9007	MERCEDES	26	1	145						Ø14	24	N 42x1,5x26x9 H DIN 5480	right
926011	9007	MERCEDES	26	1	145						Ø14	24	N 42x1,5x26x9 H DIN 5480	left
926014	9011	MERCEDES	26	1	145						Ø14	24	N 42x1,5x26x9 H DIN 5480	
926015	9011	MERCEDES	26	1	145						Ø14	24	N 42x1,5x26x9 H DIN 5480	
926016	9012	DAF	26	1	140						x,Ø22	30	N 42x1,5x26x9 H DIN 5480	right
926017	9012	DAF	26	1	140						x,Ø22	30	N 42x1,5x26x9 H DIN 5480	left
926018	9011	MERCEDES	26	1	145						Ø14	22	N 42x1,5x26x9 H DIN 5480	right
926019	9011	MERCEDES	26	1	145						Ø14	22	N 42x1,5x26x9 H DIN 5480	left
926020	9002		26	1	250								N 42x1,5x26x9 H DIN 5480	
926021	9063	BPW	26	1	215								N 42x1,5x26x9 H DIN 5480	
926022	9063	BPW	26	1	215								N 42x1,5x26x9 H DIN 5480	
926023	9072	DAF	26	1	145						Ø14	24	N 42x1,5x26x9 H DIN 5480	right
926024	9071	DAF	26	1	145						Ø14	24	N 42x1,5x26x9 H DIN 5480	left
926025	9081	MERCEDES	26	1	145						Ø14	24	N 42x1,5x26x9 H DIN 5480	right
926026	9081	MERCEDES	26	1	145						Ø14	24	N 42x1,5x26x9 H DIN 5480	left
926027	9069	DAF	26	1	140						Ø14	30	N 42x1,5x26x9 H DIN 5480	right
926028	9069	DAF	26	1	140						Ø14	30	N 42x1,5x26x9 H DIN 5480	left
926029	9072	BPW	26	1	145						Ø14	24	N 42x1,5x26x9 H DIN 5480	right
926030	9071	BPW	26	1	145						Ø14	24	N 42x1,5x26x9 H DIN 5480	left
926031	9057	DAF	26	1	140						Ø14	30	N 42x1,5x26x9 H DIN 5480	right
926032	9057	DAF	26	1	140						Ø14	30	N 42x1,5x26x9 H DIN 5480	left
926033	9072	BPW	26	1	145						Ø14	26	N 42x1,5x26x9 H DIN 5480	right
926035	9041	BPW	26	1	148						Ø14	22	N 42x1,5x26x9 H DIN 5480	right
926036	9041	BPW	26	1	148						Ø14	22	N 42x1,5x26x9 H DIN 5480	left
926037	9036	MERCEDES	26	1	145						Ø14	24	N 42x1,5x26x9 H DIN 5480	right
926038	9035	MERCEDES	26	1	145						Ø14	24	N 42x1,5x26x9 H DIN 5480	left
926039	9027	BPW	26	1	115						Ø14	24	N 42x1,5x26x9 H DIN 5480	right
926040	9027	BPW	26	1	115						Ø14	24	N 42x1,5x26x9 H DIN 5480	left
926041	9092	MERCEDES	26	1	145						Ø14	24	N 42x1,5x26x9 H DIN 5480	right
926042	9091	MERCEDES	26	1	145						Ø14	24	N 42x1,5x26x9 H DIN 5480	left
926043	9068	MERCEDES	26	1	145						Ø14	24	N 42x1,5x26x9 H DIN 5480	right
926044	9067	MERCEDES	26	1	145						Ø14	24	N 42x1,5x26x9 H DIN 5480	left
926045	9053	DAF	26	1	145						Ø14	24	N 42x1,5x26x9 H DIN 5480	right
926046	9054	DAF	26	1	145						Ø14	24	N 42x1,5x26x9 H DIN 5480	left
926047	9053	MERCEDES	26	1	145						Ø14	24	N 42x1,5x26x9 H DIN 5480	right
926048	9054	MERCEDES	26	1	145						Ø14	24	N 42x1,5x26x9 H DIN 5480	left
926049	9036	BPW	26	1	145						Ø14	24	N 42x1,5x26x9 H DIN 5480	right
926050	9035	BPW	26	1	145						Ø14	24	N 42x1,5x26x9 H DIN 5480	left
926051	9030	BPW	26	1	130						Ø14	26	N 42x1,5x26x9 H DIN 5480	right
926052	9029	BPW	26	1	130						Ø14	26	N 42x1,5x26x9 H DIN 5480	left
926053	9060	MERCEDES	26	2	145	105					H1:Ø8 (H2:Ø10)	26	N 42x1,5x26x9 H DIN 5480	right
926054	9060	MERCEDES	26	2	145	105					H1:Ø8 (H2:Ø10)	26	N 42x1,5x26x9 H DIN 5480	left



* CS > Customer Specific / Özel İmalat

ALL ORIGINAL NUMBERS, MARKS AND MODELS FROM VEHICLE MANUFACTURERS LISTED IN THIS CATALOGUE ARE FOR COMPARISON PURPOSES ONLY AND MAY NOT BE USED IN INVOICES TO VEHICLE OWNERS OR RESELLERS / ORJINAL ÜRÜN NUMARALARI MÜŞTERİYİ BİLGİLENDİRME VE ÜRÜNE REFERANS AMAÇLI KULLANILMIŞTIR.

TECHNICAL LIST

AYS CODE	CASTING	APPLICATION	NO OF SPLINE TEETH	NO of HOLE	H1	H2	H3	H4	H5	H6	BUSHING (mm)	U-Lock	SPLINE TYPE	SIDE OF MOUNTING
926055	9062	MERCEDES	26	1	145						Ø14	24	N 42x1,5x26x9 H DIN 5480	right
926056	9066	BPW	26	1	145						Ø14	24	N 42x1,5x26x9 H DIN 5480	right
926057	9065	BPW	26	1	145						Ø14	24	N 42x1,5x26x9 H DIN 5480	left
926058	9053	DAF	26	1	145						Ø14	24	N 42x1,5x26x9 H DIN 5480	right
926059	9054	DAF	26	1	145						Ø14	24	N 42x1,5x26x9 H DIN 5480	left
926060	9074	MERCEDES	26	1	145						Ø14	24	N 42x1,5x26x9 H DIN 5480	right
926061	9073	MERCEDES	26	1	145						Ø14	24	N 42x1,5x26x9 H DIN 5480	left
926062	9074	BPW	26	1	145						Ø14	24	N 42x1,5x26x9 H DIN 5480	right
926063	9073	BPW	26	1	145						Ø14	24	N 42x1,5x26x9 H DIN 5480	left
927002	9039	BPW	27	1	245						Ø14	26	D=42 M=1,5 Z=27 PRE 22-151	right
927003	9039	BPW	27	1	245						Ø14	26	D=42 M=1,5 Z=27 PRE 22-151	left
927004	9021	BPW	27	1	180							26	D=42 M=1,5 Z=27 PRE 22-151	right
927005	9021	BPW	27	1	180							26	D=42 M=1,5 Z=27 PRE 22-151	left
927006	9031	BPW	27	1	170							26	D=42 M=1,5 Z=27 PRE 22-151	right
927007	9031	BPW	27	1	170							26	D=42 M=1,5 Z=27 PRE 22-151	Left
927008	9021	RENAULT-VI	27	1	180						Ø14	24	D=42 M=1,5 Z=27 PRE 22-151	right
927009	9021	RENAULT-VI	27	1	180						Ø14	24	D=42 M=1,5 Z=27 PRE 22-151	left
927010	9047	RENAULT-VI	27	3	190	160	102				Ø14	28	D=42 M=1,5 Z=27 PRE 22-151	right
927011	9047	RENAULT-VI	27	3	190	160	102				Ø14	28	D=42 M=1,5 Z=27 PRE 22-151	left
927012	9055	BPW	27	1	175							24	D=42 M=1,5 Z=27 PRE 22-151	right
927013	9055	BPW	27	1	175							24	D=42 M=1,5 Z=27 PRE 22-151	left
936000	9000	BPW	36	1	165						Ø14	26	30x34 DIN 5481	right
936001	9000	BPW	36	1	165						Ø14	26	30x34 DIN 5481	left
936002	9000	BPW	36	1	130						Ø14	26	30x34 DIN 5481	right
936003	9000	BPW	36	1	130						Ø14	26	30x34 DIN 5481	left
936004	9000	BPW	36	1	110						Ø14	30	30x34 DIN 5481	right
936005	9000	BPW	36	1	110						Ø14	30	30x34 DIN 5481	left
936006	9000	BPW	36	1	165						Ø14	30	30x34 DIN 5481	right
936007	9000	BPW	36	1	165						Ø14	30	30x34 DIN 5481	left
936008	9000	BPW	36	1	165						Ø14	26	30x34 DIN 5481	right
936009	9000	BPW	36	1	165						Ø14	26	30x34 DIN 5481	left
936010	9051	BPW	36	1	230						Ø14	26	30x34 DIN 5481	right
936011	9051	BPW	36	1	230						Ø14	26	30x34 DIN 5481	left
936012	9043	BPW	36	1	165						Ø14	26	30x34 DIN 5481	right
936013	9043	BPW	36	1	165						Ø14	26	30x34 DIN 5481	left
936014	9051		36	1	215						Ø14	26	30x34 DIN 5481	right
936015	9051		36	1	215						Ø14	26	30x34 DIN 5481	left
937000	9000	BPW	37	1	180						Ø14	20	36x40 DIN 5481	right
937001	9002	EVO-BUS	37	3	290	180	150				Ø14	30	36x40 DIN 5481	right
937002	9002	KAESSBOHRER	37	3	290	180	150				Ø14	30	36x40 DIN 5481	left
937003	9000	BPW	37	2	180	150					Ø14	20	36x40 DIN 5481	right
937004	9000	BPW	37	2	180	150					Ø14	20	36x40 DIN 5481	left
937005	9000	BPW	37	1	140						Ø14	24	36x40 DIN 5481	right
937006	9000	BPW	37	1	140						Ø14	24	36x40 DIN 5481	left
937007	9002	BPW	37	4	230	180	150	120			Ø14	30	36x40 DIN 5481	right
937008	9002	BPW	37	4	230	180	150	120			Ø14	30	36x40 DIN 5481	left
937009	9008	BPW	37	2	260	170					Ø14	20	36x40 DIN 5481	right
937010	9008	BPW	37	2	260	170					Ø14	20	36x40 DIN 5481	left
937011	9017	MAN	37	2	150	120					Ø14	24	36x40 DIN 5481	right
937012	9017	MAN	37	2	150	120					Ø14	24	36x40 DIN 5481	left
937013	9087	BPW	37	1	160						Ø14	24	36x40 DIN 5481	right
937014	9087	BPW	37	1	160						Ø14	24	36x40 DIN 5481	left

PART NUMBER - AYS CODE

PART NUMBER	AYS CODE	PART NUMBER	AYS CODE	PART NUMBER	AYS CODE	PART NUMBER	AYS CODE	PART NUMBER	AYS CODE
4335430140	919000	4335711050	910032	4335725010	937012	4335745000	936010	4335767010	926038
4335430150	919001	4335711060	910033	4335725060	937013	4335745010	936011	4335767040	926039
4335430240	919002	4335711070	910034	4335725070	937014	4335745020	936012	4335767050	926040
4335430250	919003	4335715060	910035	4335730060	919100	4335745030	936013	4335767060	926041
4335430260	919004	4335715070	910036	4335730070	919101	4335745040	936014	4335767070	926042
4335430270	919005	4335715140	910037	4335730130	919102	4335745050	936015	4335767080	926043
4335435060	919006	4335715150	910038	4335730140	919103	4335750000	920100	4335767090	926044
4335435070	919007	4335715160	910039	4335730150	919104	4335750010	920101	4335767100	926045
4335435140	919008	4335715170	910040	4335730200	919105	4335750020	920102	4335767110	926046
4335435150	919009	4335715200	910041	4335730210	919106	4335750030	920103	4335767120	926047
4335435160	919010	4335715210	910042	4335730220	919107	4335750040	920104	4335767130	926048
4335435170	919011	4335715220	910043	4335730230	919108	4335750050	920105	4335767140	926049
4335435180	919012	4335715230	910044	4335730240	919109	4335750060	920106	4335767150	926050
4335435190	919013	4335715240	910045	4335730250	919110	4335750070	920107	4335767160	926051
4335435200	919014	4335715250	910046	4335730260	919111	4335755020	920108	4335767170	926052
4335435210	919015	4335715320	910047	4335730270	919112	4335755030	920109	4335767180	926053
4335435220	919016	4335715330	910048	4335730300	919113	4335760000	926000	4335767190	926054
4335435230	919017	4335715360	910049	4335730310	919114	4335760010	926001	4335767200	926055
4335435240	919018	4335715370	910050	4335730340	919115	4335761020	926002	4335767220	926056
4335435250	919019	4335715380	910051	4335730360	919116	4335761030	926003	4335767230	926057
4335665000	920000	4335715390	910052	4335730370	919117	4335761050	926004	4335767240	926058
4335665010	920001	4335715580	910053	4335731000	919118	4335761100	926005	4335767250	926059
4335665020	920002	4335715590	910054	4335731020	919119	4335761110	926006	4335767280	926060
4335710000	910001	4335715600	910055	4335731030	919120	4335761120	926007	4335767290	926061
4335710010	910002	4335715610	910056	4335731300	919121	4335761130	926008	4335767400	926062
4335710020	910003	4335715660	910057	4335731310	919122	4335761140	926009	4335767410	926063
4335710030	910004	4335715670	910058	4335731320	919123	4335761160	926010	4335775000	908000
4335710040	910005	4335715680	910059	4335731330	919124	4335761170	926011	4335775010	908001
4335710050	910006	4335715690	910060	4335735000	919125	4335761180	926012	4335775020	908002
4335710100	910007	4335715700	910061	4335735010	919126	4335761190	926013	4335775030	908003
4335710110	910008	4335715710	910062	4335735060	919127	4335761200	926014	4335775040	908004
4335710120	910009	4335715720	910063	4335735070	919128	4335761210	926015	4335775050	908005
4335710130	910010	4335715730	910064	4335735120	919129	4335761220	926016	4335785020	927000
4335710140	910011	4335715740	910065	4335735130	919130	4335761230	926017	4335785030	927001
4335710150	910012	4335715750	910066	4335735140	919131	4335761240	926018	4335785040	927002
4335710160	910013	4335717000	910067	4335735150	919132	4335761250	926019	4335785050	927003
4335710170	910014	4335717010	910068	4335735160	919133	4335764000	926020	4335785060	927004
4335710180	910015	4335717020	910069	4335735170	919134	4335765000	926021	4335785070	927005
4335710190	910016	4335717030	910070	4335735200	919135	4335765010	926022	4335785100	927006
4335710200	910017	4335717050	910071	4335735210	919136	4335765020	926023	4335785110	927007
4335710210	910018	4335717060	910072	4335735280	919137	4335765030	926024	4335785120	927008
4335710240	910019	4335717070	910073	4335735290	919138	4335765080	926025	4335785130	927009
4335710250	910020	4335720000	937000	4335737020	919139	4335765090	926026	4335785160	927010
4335710260	910021	4335720020	937001	4335737030	919140	4335765120	926027	4335785170	927011
4335710270	910022	4335720030	937002	4335740000	936000	4335765130	926028	4335787000	927012
4335710280	910023	4335720040	937003	4335740010	936001	4335765140	926029	4335787010	927013
4335710290	910024	4335720050	937004	4335740020	936002	4335765150	926030	c.s	910074
4335710340	910025	4335720080	937005	4335740030	936003	4335765160	926031	c.s	910075
4335710350	910026	4335720090	937006	4335740040	936004	4335765170	926032	c.s	920110
4335710360	910027	4335720100	937007	4335740050	936005	4335765180	926033	c.s	920111
4335710370	910028	4335720110	937008	4335740060	936006	4335765190	926034	c.s	920112
4335711020	910029	4335721060	937009	4335740070	936007	4335765200	926035	c.s	920113
4335711030	910030	4335721070	937010	4335740080	936008	4335765210	926036	c.s	920114
4335711040	910031	4335725000	937011	4335740090	936009	4335767000	926037	c.s	920115



CROSS REFERENCE LIST

OEM NO	PART NUMBER	AYS CODE	OEM NO	PART NUMBER	AYS CODE	OEM NO	PART NUMBER	AYS CODE
193861	4335785120	927008	517472200	4335760010	926000	517476110	4335761250	926019
193861	4335785120	927008	517472210	4335720090	937006	517476120	4335761240	926018
193862	4335785130	927009	517472220	4335720080	937005	517476230	4335767230	926057
193862	4335785130	927009	517472250	4335430250	919003	517476240	4335767220	926056
225879	4335715070	910036	517472260	4335430240	919002	517476250	4335767250	926059
225880	4335715060	910035	517472270	4335430150	919001	517476260	4335767240	926058
225903	4335710040	910005	517472280	4335430140	919000	517476310	4335767400	926062
225904	4335710050	910006	517472490	4335430270	919005	517476320	4335767410	926063
391510	4335715720	910063	517472500	4335430260	919004	517492010	4335710210	910018
391511	4335715730	910064	517472810	4335720110	937008	517492020	4335710200	910017
505843	4335710340	910025	517472820	4335720100	937007	517492020	4335710290	910024
505844	4335710350	910026	517474020	4335785100	927006	517492040	4335710010	910002
634752	4335715610	910056	517474030	4335785110	927007	517492050	4335710100	910007
634753	4335715600	910055	517474180	4335785120	927008	517492060	4335710110	910008
634754	4335711020	910029	517474190	4335785130	927009	517492070	4335720030	937002
634755	4335711030	910030	517474200	4335715590	910054	517492080	4335720040	937003
640117	4335711040	910031	517474210	4335715580	910053	517492090	4335720050	937004
640118	4335711050	910032	517474220	4335715600	910055	517492100	4335720000	937000
651521	4335765130	926028	517474230	4335715610	910056	517492120	4335710020	910003
651522	4335765120	926027	517474240	4335735120	919129	517492130	4335710030	910004
651525	4335760000	926000	517474250	4335735130	919130	517492140	4335710120	910009
651525	4335760010	926000	517474280	4335735200	919135	517492150	4335710130	910010
651526	4335760000	926000	517474290	4335735210	919136	517492160	4335710140	910011
651526	4335760010	926000	517474300	4335785160	927010	517492170	4335710150	910012
652446	4335711060	910033	517474310	4335785170	927011	517492220	4335710160	910013
652446	4335711070	910034	517474540	4335765120	926027	517492230	4335710170	910014
652447	4335711060	910033	517474550	4335765130	926028	517492340	4335710000	910001
652447	4335711070	910034	517474560	4335665020	920002	517492350	4335710010	910002
652816	4335715680	910059	517474580	4335715680	910059	517492360	4335710040	910005
652816	4335715690	910059	517474590	4335715690	910060	517492370	4335710050	910006
652817	4335715680	910059	517474600	4335725060	937013	517492380	4335710180	910015
652817	4335715690	910059	517474610	4335725070	937014	517492390	4335710190	910016
659157	4335715660	910057	517474640	4335715660	910057	517492400	4335750000	920100
659158	4335715670	910058	517474650	4335715670	910058	517492410	4335750010	920101
671219	4335765170	926032	517474660	4335435200	919014	517492420	4335750020	920102
671220	4335765160	926031	517474670	4335435210	919015	517492430	4335750030	920103
672953	4335761220	926016	517474680	4335435140	919008	517492440	4335730060	919100
672954	4335761230	926017	517474690	4335435150	919009	517492450	4335730070	919101
693683	4335735130	919130	517474700	4335435060	919006	517492570	4335730130	919102
693685	4335735120	919129	517474710	4335435070	919007	517492580	4335730140	919103
1518704	4335435160	919010	517474740	4335765160	926031	517492590	4335730150	919104
1518705	4335435170	919011	517474750	4335765170	926032	517492640	4335740000	936000
1518706	4335765020	926023	517474780	4335765180	926033	517492650	4335740010	936001
1518707	4335765030	926024	517474790	4335765190	926034	517492660	4335740020	936002
1518708	4335767000	926037	517474820	4335435180	919012	517492670	4335740030	936003
1518710	4335767100	926045	517474830	4335435190	919013	517492680	4335710260	910021
1518711	4335767110	926046	517474840	4335435160	919010	517492690	4335710270	910022
1518712	4335767240	926058	517474850	4335435170	919011	517492700	4335750040	920104
1518713	4335767250	926059	517474880	4335715700	910061	517492710	4335750050	920105
70170601	4335710050	910006	517474890	4335715710	910062	517492720	4335740040	936004
70170602	4335710040	910005	517474900	4335435220	919016	517492730	4335740050	936005
70351302	4335430240	919002	517474910	4335435230	919017	517492740	4335740060	936006
70351303	4335430250	919003	517474940	4335435240	919018	517492750	4335740070	936007
517472050	4335710370	910028	517474950	4335435250	919019	517492760	4335710280	910023
517472060	4335710360	910027	517474980	4335715730	910064	517492770	4335710290	910024
517472070	4335730270	919112	517474990	4335715720	910063	517492830	4335730210	919106
517472080	4335730260	919111	517475130	4335765210	926036	517492840	4335730220	919107
517472170	4335730310	919114	517475140	4335765200	926035	517492850	4335730230	919108
517472180	4335730300	919113	517475150	4335715750	910066	517492880	4335730240	919109
517472190	4335760000	926000	517475160	4335715740	910065	517492890	4335730250	919110
517472190	4335760010	926000	517475180	4335735280	919137	517492900	4335740080	936008
517472200	4335760000	926000	517475190	4335735290	919138	517492910	4335740090	936009

CROSS REFERENCE LIST

OEM NO	PART NUMBER	AYS CODE	OEM NO	PART NUMBER	AYS CODE	OEM NO	PART NUMBER	AYS CODE
517492940	4335710340	910025	517496110	4335731020	919119	517498470	4335761170	926011
517492950	4335710350	910026	517496120	4335731030	919120	517498480	4335761160	926010
517492960	4335750060	920106	517496170	4335761030	926003	517498510	4335721070	937010
517492970	4335750070	920107	517496180	4335761020	926002	517498520	4335721060	937009
517492980	4335720020	937001	517496210	4335761050	926004	637204590	4335775000	908000
517494100	4335775000	908000	517496290	4335767050	926040	637204600	4335775010	908001
517494110	4335775010	908001	517496300	4335767040	926039	637204610	4335775020	908002
517494120	4335775020	908002	517496310	4335735170	919134	637204620	4335775030	908003
517494130	4335775030	908003	517496320	4335735160	919133	637204640	4335775050	908005
517494150	4335775050	908005	517496410	4335711030	910030	3024202138	4335731300	919121
517494160	4335715220	910043	517496420	4335711020	910029	3024202238	4335731310	919122
517494170	4335715230	910044	517496450	4335761110	926006	3174202238	4335735000	919125
517494180	4335735060	919127	517496460	4335761100	926005	3174202238	4335735160	919133
517494190	4335735070	919128	517496470	4335711050	910032	3174202338	4335735010	919126
517494200	4335725000	937011	517496480	4335711040	910031	3174202338	4335735170	919134
517494210	4335710250	910020	517496570	4335761130	926008	3174202438	4335735160	919133
517494210	4335725010	937012	517496580	4335761120	926007	3174202538	4335735170	919134
517494220	4335715200	910041	517496590	4335767010	926038	3184200238	4335767180	926053
517494230	4335715210	910042	517496600	4335767000	926037	3184200338	4335767190	926054
517494260	4335715060	910035	517496610	4335767070	926042	3844200038	4335767280	926060
517494270	4335715070	910036	517496620	4335767060	926041	3844200038	4335767400	926062
517494300	4335665000	920000	517496630	4335767090	926044	3844200138	4335767290	926061
517494310	4335665010	920001	517496640	4335767080	926043	3844200138	4335767410	926063
517494340	4335715140	910037	517496690	4335765080	926025	3854202138	4335767200	926055
517494350	4335715150	910038	517496690	4335765090	926026	3874200238	4335765020	926023
517494380	4335715160	910039	517496700	4335765080	926025	3874200338	4335765030	926024
517494390	4335715170	910040	517496700	4335765090	926026	3884200438	4335767400	926062
517494400	4335755030	920109	517496770	4335767110	926046	3884200538	4335767410	926063
517494410	4335755020	920108	517496780	4335767100	926045	3894200338	4335767000	926037
517494540	4335785020	927000	517496790	4335767130	926048	3894200438	4335767010	926038
517494550	4335785030	927001	517496800	4335767120	926047	3894200538	4335761100	926005
517494560	4335715320	910047	517496810	4335767150	926050	3894200638	4335761110	926006
517494570	4335715330	910048	517496820	4335767140	926049	5000785214	4335785120	927008
517494580	4335745000	936010	517496830	4335711060	910033	5000785215	4335785130	927009
517494600	4335715360	910049	517496830	4335711070	910034	5000785216	4335785160	927010
517494610	4335715370	910050	517496840	4335711060	910033	5000785217	4335785170	927011
517494640	4335745020	936012	517496840	4335711070	910034	6154200038	4335761200	926014
517494650	4335745030	936013	517496850	4335767170	926052	6154200138	4335761210	926015
517494660	4335715380	910051	517496860	4335767160	926051	6204200038	4335767140	926049
517494670	4335715390	910052	517496870	4335767190	926054	6204200138	4335767150	926050
517494680	4335785050	927003	517496880	4335767180	926053	6204200238	4335761240	926018
517494690	4335785040	927002	517496890	4335787010	927013	6204200338	4335761250	926019
517494700	4335785060	927004	517496900	4335787000	927012	6214200038	4335767080	926043
517494710	4335785070	927005	517496910	4335765150	926030	6214200138	4335767090	926044
517494720	4335765030	926024	517496920	4335765140	926029	6234200238	4335767060	926041
517494730	4335765020	926023	517496930	4335761210	926015	6234200338	4335767070	926042
517494740	4335785100	927006	517496940	4335761200	926014	6234200438	4335765090	926026
517494750	4335785110	927007	517496960	4335767200	926055	6234200538	4335765080	926025
517494760	4335765000	926021	517496970	4335761230	926017	6234200838	4335761130	926008
517494770	4335765010	926022	517496980	4335761220	926016	6234200938	4335761120	926007
517494940	4335735140	919131	517498030	4335717000	910067	6234201238	4335767100	926045
517494950	4335735150	919132	517498040	4335717010	910068	6234201338	4335767110	926046
517495740	4335761140	926009	517498190	4335717030	910070	6234201438	4335767120	926047
517496010	4335731300	919121	517498200	4335717020	910069	6234201538	4335767130	926048
517496020	4335731310	919122	517498210	4335710250	910020	6234201638	4335761160	926010
517496030	4335731320	919123	517498210	4335725010	937012	6234201738	4335761170	926011
517496040	4335731330	919124	517498220	4335710240	910019	6584200038	4335767220	926056
517496050	4335735000	919125	517498230	4335715250	910046	6584200138	4335767230	926057
517496050	4335735160	919133	517498240	4335715240	910045	6584200238	4335767240	926058
517496060	4335735010	919126	517498270	4335717050	910071	6584200338	4335767250	926059
517496060	4335735170	919134	517498280	4335717060	910072	8283000312	4335720030	937002
517496080	4335731000	919118	517498290	4335717070	910073	8283000316	4335735060	919127



CROSS REFERENCE LIST

OEM NO	PART NUMBER	AYS CODE	OEM NO	PART NUMBER	AYS CODE	OEM NO	PART NUMBER	AYS CODE
8283000316	4335735060	919127	99000340066	4335735130	919130	05.174.74.20.0	4335715590	910054
8283000317	4335735070	919128	99000440023	4335730260	919111	05.174.74.21.0	4335715580	910053
8283000336	4335730140	919103	99000440024	4335730270	919112	05.174.74.22.0	4335715600	910055
8283000337	4335730150	919104	99000440024	4335730270	919112	05.174.74.23.0	4335715610	910056
8283000411	4335730240	919109	99112440063	4335735290	919138	05.174.74.24.0	4335735120	919129
8283000412	4335730250	919110	99112440064	4335735280	919137	05.174.74.25.0	4335735130	919130
8283000552	4335730140	919103	99118440005	4335730360	919116	05.174.74.28.0	4335735200	919135
8283000553	4335730150	919104	99118440006	4335730370	919117	05.174.74.29.0	4335735210	919136
8283000589	4335735200	919135	2530123007832	4335767060	926041	05.174.74.30.0	4335785160	927010
8283000590	4335735210	919136	2530123010475	4335767070	926042	05.174.74.31.0	4335785170	927011
8283000733	4335430140	919000	2530123010476	4335765080	926025	05.174.74.54.0	4335765120	926027
8283000734	4335430150	919001	2530123010476	4335765090	926026	05.174.74.55.0	4335765130	926028
8283000735	4335430240	919002	2530123010477	4335765080	926025	05.174.74.56.0	4335665020	920002
8283000736	4335430250	919003	2530123010477	4335765090	926026	05.174.74.58.0	4335715680	910059
8283000737	4335435140	919008	2530123021562	4335761110	926006	05.174.74.59.0	4335715690	910060
8283000738	4335435150	919009	2530123021563	4335761100	926005	05.174.74.60.0	4335725060	937013
8283000739	4335435200	919014	2530123105759	4335767120	926047	05.174.74.61.0	4335725070	937014
8283000740	4335435210	919015	2530123105760	4335767130	926048	05.174.74.64.0	4335715660	910057
8283000746	4335435060	919006	2530123142269	4335765020	926023	05.174.74.65.0	4335715670	910058
8283000747	4335435070	919007	2530123142270	4335765030	926024	05.174.74.66.0	4335435200	919014
8283000764	4335430260	919004	2530123150071	4335767010	926038	05.174.74.67.0	4335435210	919015
8283000764	4335430270	919005	2530123150073	4335767000	926037	05.174.74.68.0	4335435140	919008
8283000765	4335430260	919004	2530123209203	4335735120	919129	05.174.74.69.0	4335435150	919009
8283000765	4335430270	919005	2530123209204	4335735130	919130	05.174.74.70.0	4335435060	919006
8283000778	4335435160	919010	2530233007832	4335767060	926041	05.174.74.71.0	4335435070	919007
8283000779	4335435170	919011	2530233010475	4335767070	926042	05.174.74.74.0	4335765160	926031
8283000799	4335720020	937001	2530233010476	4335765090	926026	05.174.74.75.0	4335765170	926032
8283000802	4335435220	919016	2530233010477	4335765080	926025	05.174.74.78.0	4335765180	926033
8283000803	4335435230	919017	2530233021562	4335761110	926006	05.174.74.79.0	4335765190	926034
8285000086	4335435250	919019	2530233021563	4335761100	926005	05.174.74.82.0	4335435180	919012
8285000087	4335435240	919018	2530233105759	4335767120	926047	05.174.74.83.0	4335435190	919013
26033012010	4335730340	919115	2530233105760	4335767130	926048	05.174.74.84.0	4335435160	919010
81503036001	4335710250	910020	2530233142269	4335765020	926023	05.174.74.85.0	4335435170	919011
81503036001	4335725010	937012	2530233142270	4335765030	926024	05.174.74.88.0	4335715700	910061
81506106068	4335665000	920000	2530233150071	4335767010	926038	05.174.74.89.0	4335715710	910062
81506106069	4335665010	920001	2530233150073	4335767000	926037	05.174.74.90.0	4335435220	919016
81506106118	4335765030	926024	2530233209203	4335735120	919129	05.174.74.91.0	4335435230	919017
81506106131	4335665020	920002	2530233209204	4335735130	919130	05.174.74.94.0	4335435240	919018
82830003120	4335720030	937002	05.174.72.05.0	4335710370	910028	05.174.74.95.0	4335435250	919019
82830003120	4335720030	937002	05.174.72.06.0	4335710360	910027	05.174.74.98.0	4335715730	910064
82830007340	4335430150	919001	05.174.72.07.0	4335730270	919112	05.174.74.99.0	4335715720	910063
82830007350	4335430240	919002	05.174.72.08.0	4335730260	919111	05.174.75.13.0	4335765210	926036
82830007360	4335430250	919003	05.174.72.17.0	4335730310	919114	05.174.75.14.0	4335765200	926035
82830007370	4335435140	919008	05.174.72.18.0	4335730300	919113	05.174.75.15.0	4335715750	910066
82830007380	4335435150	919009	05.174.72.19.0	4335760000	926000	05.174.75.16.0	4335715740	910065
82830007390	4335435200	919014	05.174.72.19.0	4335760010	926001	05.174.75.18.0	4335735280	919137
82830007400	4335435210	919015	05.174.72.20.0	4335760000	926000	05.174.75.19.0	4335735290	919138
82830007460	4335435060	919006	05.174.72.20.0	4335760010	926001	05.174.76.11.0	4335761250	926019
82830007470	4335435070	919007	05.174.72.21.0	4335720090	937006	05.174.76.12.0	4335761240	926018
82830007640	4335430260	919004	05.174.72.22.0	4335720080	937005	05.174.76.23.0	4335767230	926057
82830007650	4335430270	919005	05.174.72.25.0	4335430250	919003	05.174.76.24.0	4335767220	926056
82830007780	4335435160	919010	05.174.72.26.0	4335430240	919002	05.174.76.25.0	4335767250	926059
82830007800	4335435180	919012	05.174.72.27.0	4335430150	919001	05.174.76.26.0	4335767240	926058
82830008030	4335435230	919017	05.174.72.28.0	4335430140	919000	05.174.76.31.0	4335767400	926062
82850000860	4335435250	919019	05.174.72.49.0	4335430270	919005	05.174.76.32.0	4335767410	926063
82850000870	4335435240	919018	05.174.72.50.0	4335430260	919004	05.174.92.01.0	4335710210	910018
84503036001	4335710250	910020	05.174.72.81.0	4335720110	937008	05.174.92.02.0	4335710200	910017
84503036001	4335725010	937012	05.174.72.82.0	4335720100	937007	05.174.92.02.0	4335710290	910024
84503046001	4335725000	937011	05.174.74.02.0	4335785100	927006	05.174.92.04.0	4335710010	910002
85500013679	4335735120	919129	05.174.74.03.0	4335785110	927007	05.174.92.05.0	4335710100	910007
85500013680	4335735130	919130	05.174.74.18.0	4335785120	927008	05.174.92.06.0	4335710110	910008
99000340065	4335735120	919129	05.174.74.19.0	4335785130	927009	05.174.92.07.0	4335720030	937002

CROSS REFERENCE LIST

OEM NO	PART NUMBER	AYS CODE	OEM NO	PART NUMBER	AYS CODE	OEM NO	PART NUMBER	AYS CODE
05.174.92.08.0	4335720040	937003	05.174.94.20.0	4335725000	937011	05.174.96.48.0	4335711040	910031
05.174.92.09.0	4335720050	937004	05.174.94.21.0	4335710250	910020	05.174.96.57.0	4335761130	926008
05.174.92.10.0	4335720000	937000	05.174.94.21.0	4335725010	937012	05.174.96.58.0	4335761120	926007
05.174.92.12.0	4335710020	910003	05.174.94.22.0	4335715200	910041	05.174.96.59.0	4335767010	926038
05.174.92.13.0	4335710030	910004	05.174.94.23.0	4335715210	910042	05.174.96.60.0	4335767000	926037
05.174.92.14.0	4335710120	910009	05.174.94.26.0	4335715060	910035	05.174.96.61.0	4335767070	926042
05.174.92.15.0	4335710130	910010	05.174.94.27.0	4335715070	910036	05.174.96.62.0	4335767060	926041
05.174.92.16.0	4335710140	910011	05.174.94.30.0	4335665000	920000	05.174.96.63.0	4335767090	926044
05.174.92.17.0	4335710150	910012	05.174.94.31.0	4335665010	920001	05.174.96.64.0	4335767080	926043
05.174.92.22.0	4335710160	910013	05.174.94.34.0	4335715140	910037	05.174.96.69.0	4335765080	926025
05.174.92.23.0	4335710170	910014	05.174.94.35.0	4335715150	910038	05.174.96.69.0	4335765090	926026
05.174.92.34.0	4335710000	910001	05.174.94.38.0	4335715160	910039	05.174.96.70.0	4335765080	926025
05.174.92.35.0	4335710010	910002	05.174.94.39.0	4335715170	910040	05.174.96.70.0	4335765090	926026
05.174.92.36.0	4335710040	910005	05.174.94.40.0	4335755030	920109	05.174.96.74.0	4335761140	926009
05.174.92.37.0	4335710050	910006	05.174.94.41.0	4335755020	920108	05.174.96.77.0	4335767110	926046
05.174.92.38.0	4335710180	910015	05.174.94.54.0	4335785020	927000	05.174.96.78.0	4335767100	926045
05.174.92.39.0	4335710190	910016	05.174.94.55.0	4335785030	927001	05.174.96.79.0	4335767130	926048
05.174.92.40.0	4335750000	920100	05.174.94.56.0	4335715320	910047	05.174.96.80.0	4335767120	926047
05.174.92.41.0	4335750010	920101	05.174.94.57.0	4335715330	910048	05.174.96.81.0	4335767150	926050
05.174.92.42.0	4335750020	920102	05.174.94.58.0	4335745000	936010	05.174.96.82.0	4335767140	926049
05.174.92.43.0	4335750030	920103	05.174.94.60.0	4335715360	910049	05.174.96.83.0	4335711060	910033
05.174.92.44.0	4335730060	919100	05.174.94.61.0	4335715370	910050	05.174.96.83.0	4335711070	910034
05.174.92.45.0	4335730070	919101	05.174.94.64.0	4335745020	936012	05.174.96.84.0	4335711060	910033
05.174.92.57.0	4335730130	919102	05.174.94.65.0	4335745030	936013	05.174.96.84.0	4335711070	910034
05.174.92.58.0	4335730140	919103	05.174.94.66.0	4335715380	910051	05.174.96.85.0	4335767170	926052
05.174.92.59.0	4335730150	919104	05.174.94.67.0	4335715390	910052	05.174.96.86.0	4335767160	926051
05.174.92.64.0	4335740000	936000	05.174.94.68.0	4335785050	927003	05.174.96.87.0	4335767190	926054
05.174.92.65.0	4335740010	936001	05.174.94.69.0	4335785040	927002	05.174.96.88.0	4335767180	926053
05.174.92.66.0	4335740020	936002	05.174.94.70.0	4335785060	927004	05.174.96.90.0	4335787000	927012
05.174.92.67.0	4335740030	936003	05.174.94.71.0	4335785070	927005	05.174.96.91.0	4335765150	926030
05.174.92.68.0	4335710260	910021	05.174.94.72.0	4335765030	926024	05.174.96.92.0	4335765140	926029
05.174.92.69.0	4335710270	910022	05.174.94.73.0	4335765020	926023	05.174.96.93.0	4335761210	926015
05.174.92.70.0	4335750040	920104	05.174.94.74.0	4335785100	927006	05.174.96.94.0	4335761200	926014
05.174.92.71.0	4335750050	920105	05.174.94.75.0	4335785110	927007	05.174.96.96.0	4335767200	926055
05.174.92.72.0	4335740040	936004	05.174.94.76.0	4335765000	926021	05.174.96.97.0	4335761230	926017
05.174.92.73.0	4335740050	936005	05.174.94.77.0	4335765010	926022	05.174.96.98.0	4335761220	926016
05.174.92.74.0	4335740060	936006	05.174.94.94.0	4335735140	919131	05.174.98.03.0	4335717000	910067
05.174.92.75.0	4335740070	936007	05.174.94.95.0	4335735150	919132	05.174.98.04.0	4335717010	910068
05.174.92.76.0	4335710280	910023	05.174.95.74.0	4335761140	926009	05.174.98.19.0	4335717030	910070
05.174.92.77.0	4335710290	910024	05.174.96.01.0	4335731300	919121	05.174.98.20.0	4335717020	910069
05.174.92.82.0	4335730200	919105	05.174.96.02.0	4335731310	919122	05.174.98.21.0	4335710250	910020
05.174.92.83.0	4335730210	919106	05.174.96.03.0	4335731320	919123	05.174.98.21.0	4335725010	937012
05.174.92.84.0	4335730220	919107	05.174.96.04.0	4335731330	919124	05.174.98.22.0	4335710240	910019
05.174.92.85.0	4335730230	919108	05.174.96.05.0	4335735000	919125	05.174.98.23.0	4335715250	910046
05.174.92.88.0	4335730240	919109	05.174.96.05.0	4335735160	919133	05.174.98.24.0	4335715240	910045
05.174.92.89.0	4335730250	919110	05.174.96.06.0	4335735010	919126	05.174.98.27.0	4335717050	910071
05.174.92.90.0	4335740080	936008	05.174.96.06.0	4335735170	919134	05.174.98.28.0	4335717060	910072
05.174.92.91.0	4335740090	936009	05.174.96.08.0	4335731000	919118	05.174.98.29.0	4335717070	910073
05.174.92.94.0	4335710340	910025	05.174.96.11.0	4335731020	919119	05.174.98.47.0	4335761170	926011
05.174.92.95.0	4335710350	910026	05.174.96.12.0	4335731030	919120	05.174.98.48.0	4335761160	926010
05.174.92.96.0	4335750060	920106	05.174.96.17.0	4335761030	926003	05.174.98.51.0	4335721070	937010
05.174.92.97.0	4335750070	920107	05.174.96.18.0	4335761020	926002	05.174.98.52.0	4335721060	937009
05.174.92.98.0	4335720020	937001	05.174.96.21.0	4335761050	926004	2530 12 300 7832	4335767060	926041
05.174.94.10.0	4335775000	908000	05.174.96.29.0	4335767050	926040	2530 12 301 0475	4335767070	926042
05.174.94.11.0	4335775010	908001	05.174.96.30.0	4335767040	926039	2530 12 301 0476	4335765080	926025
05.174.94.12.0	4335775020	908002	05.174.96.31.0	4335735170	919134	2530 12 301 0476	4335765090	926026
05.174.94.13.0	4335775030	908003	05.174.96.32.0	4335735160	919133	2530 12 301 0477	4335765080	926025
05.174.94.15.0	4335775050	908005	05.174.96.41.0	4335711030	910030	2530 12 301 0477	4335765090	926026
05.174.94.16.0	4335715220	910043	05.174.96.42.0	4335711020	910029	2530 12 302 1562	4335761110	926006
05.174.94.17.0	4335715230	910044	05.174.96.45.0	4335761110	926006	2530 12 302 1563	4335761100	926005
05.174.94.18.0	4335735060	919127	05.174.96.46.0	4335761100	926005	2530 12 310 5759	4335767120	926047
05.174.94.19.0	4335735070	919128	05.174.96.47.0	4335711050	910032	2530 12 310 5760	4335767130	926048



CROSS REFERENCE LIST

OEM NO	PART NUMBER	AYS CODE	OEM NO	PART NUMBER	AYS CODE	OEM NO	PART NUMBER	AYS CODE
2530 12 314 2269	4335765020	926023	623 420 13 38	4335767110	926046	A 615 420 00 38	4335761200	926014
2530 12 314 2270	4335765030	926024	623 420 14 38	4335767120	926047	A 615 420 01 38	4335761210	926015
2530 12 315 0071	4335767010	926038	623 420 15 38	4335767130	926048	A 620 420 00 38	4335767140	926049
2530 12 315 0073	4335767000	926037	623 420 16 38	4335761160	926010	A 620 420 01 38	4335767150	926050
2530 12 320 9203	4335735120	919129	623 420 17 38	4335761170	926011	A 620 420 02 38	4335761240	926018
2530 12 320 9204	4335735130	919130	658 420 00 38	4335767220	926056	A 620 420 03 38	4335761250	926019
2530 23 300 7832	4335767060	926041	658 420 01 38	4335767230	926057	A 621 420 00 38	4335767080	926043
2530 23 301 0475	4335767070	926042	658 420 02 38	4335767240	926058	A 621 420 01 38	4335767090	926044
2530 23 301 0476	4335765090	926026	658 420 03 38	4335767250	926059	A 623 420 02 38	4335767060	926041
2530 23 301 0477	4335765080	926025	8.283.000.312.0	4335720030	937002	A 623 420 03 38	4335767070	926042
2530 23 302 1562	4335761110	926006	8.283.000.312.0	4335720030	937002	A 623 420 04 38	4335765090	926026
2530 23 302 1563	4335761100	926005	8.283.000.734.0	4335430150	919001	A 623 420 05 38	4335765080	926025
2530 23 310 5759	4335767120	926047	8.283.000.735.0	4335430240	919002	A 623 420 08 38	4335761130	926008
2530 23 310 5760	4335767130	926048	8.283.000.736.0	4335430250	919003	A 623 420 09 38	4335761120	926007
2530 23 314 2269	4335765020	926023	8.283.000.737.0	4335435140	919008	A 623 420 12 38	4335767100	926045
2530 23 314 2270	4335765030	926024	8.283.000.738.0	4335435150	919009	A 623 420 13 38	4335767110	926046
2530 23 315 0071	4335767010	926038	8.283.000.739.0	4335435200	919014	A 623 420 14 38	4335767120	926047
2530 23 315 0073	4335767000	926037	8.283.000.740.0	4335435210	919015	A 623 420 15 38	4335767130	926048
2530 23 320 9203	4335735120	919129	8.283.000.746.0	4335435060	919006	A 658 420 00 38	4335767220	926056
2530 23 320 9204	4335735130	919130	8.283.000.747.0	4335435070	919007	A 658 420 01 38	4335767230	926057
26 03301 2010	4335730340	919115	8.283.000.764.0	4335430260	919004	A 658 420 02 38	4335767240	926058
260.33.01.2010	4335730340	919115	8.283.000.765.0	4335430270	919005	A 658 420 03 38	4335767250	926059
302 420 21 38	4335731300	919121	8.283.000.778.0	4335435160	919010	A3874200238	4335765020	926023
302 420 22 38	4335731310	919122	8.283.000.780.0	4335435180	919012	A3874200338	4335765030	926024
317 420 22 38	4335735000	919125	8.283.000.803.0	4335435230	919017	A3894200338	4335767000	926037
317 420 22 38	4335735160	919133	8.285.000.086.0	4335435250	919019	A3894200438	4335767010	926038
317 420 23 38	4335735010	919126	8.285.000.087.0	4335435240	919018	A6154200038	4335761200	926014
317 420 23 38	4335735170	919134	81 50303 6001	4335710250	910020	A6154200138	4335761210	926015
317 420 24 38	4335735160	919133	81 50303 6001	4335725010	937012	A6204200038	4335767140	926049
317 420 25 38	4335735170	919134	81 50610 6068	4335665000	920000	A6204200138	4335767150	926050
318 420 02 38	4335767180	926053	81 50610 6069	4335665010	920001	A6204200238	4335761240	926018
318 420 03 38	4335767190	926054	81 50610 6118	4335765030	926024	A6204200338	4335761250	926019
384 420 00 38	4335767280	926060	81 50610 6131	4335665020	920002	A6214200038	4335767080	926043
384 420 00 38	4335767400	926062	81.50610-6118	4335765030	926024	A6214200138	4335767090	926044
384 420 01 38	4335767290	926061	828 300 07 64	4335430260	919004	A6234200238	4335767060	926041
384 420 01 38	4335767410	926063	828 300 07 64	4335430270	919005	A6234200338	4335767070	926042
385 420 21 38	4335767200	926055	828 300 07 65	4335430260	919004	A6234200438	4335765090	926026
387 420 02 38	4335765020	926023	828 300 07 65	4335430270	919005	A6234200538	4335765080	926025
387 420 03 38	4335765030	926024	84 50303 6001	4335710250	910020	A6234200838	4335761130	926008
388 420 04 38	4335767400	926062	84 50303 6001	4335725010	937012	A6234200938	4335761120	926007
388 420 05 38	4335767410	926063	84 50304 6001	4335725000	937011	A6234201238	4335767100	926045
389 420 03 38	4335767000	926037	84.50303-6001	4335725010	937012	A6234201338	4335767110	926046
389 420 04 38	4335767010	926038	84.50304-6001	4335725000	937011	A6234201438	4335767120	926047
389 420 05 38	4335761100	926005	85 50001 3679	4335735120	919129	A6234201538	4335767130	926048
389 420 06 38	4335761110	926006	85 50001 3680	4335735130	919130	A6584200038	4335767220	926056
525733012000	4335730310	919114	85.50001-3679	4335735120	919129	A6584200138	4335767230	926057
525733012010	4335730300	919113	85.50001-3680	4335735130	919130	A6584200238	4335767240	926058
615 420 00 38	4335761200	926014	99 00034 0066	4335735130	919130	A6584200338	4335767250	926059
615 420 01 38	4335761210	926015	99 00044 0024	4335730270	919112	Q8283000764	4335430260	919004
620 420 00 38	4335767140	926049	990.00.44.0024	4335730270	919112	Q8283000764	4335430270	919005
620 420 01 38	4335767150	926050	99000 340065	4335735120	919129	Q8283000765	4335430260	919004
620 420 02 38	4335761240	926018	99000 340066	4335735130	919130	Q8283000765	4335430270	919005
620 420 02 38	4335761240	926018	99000 440023	4335730260	919111			
620 420 03 38	4335761250	926019	99000 440024	4335730270	919112			
621 420 00 38	4335767080	926043	99112 440063	4335735290	919138			
621 420 01 38	4335767090	926044	99112 440064	4335735280	919137			
623 420 02 38	4335767060	926041	99118 440005	4335730360	919116			
623 420 03 38	4335767070	926042	99118 440006	4335730370	919117			
623 420 04 38	4335765090	926026	A 387 420 02 38	4335765020	926023			
623 420 05 38	4335765080	926025	A 387 420 03 38	4335765030	926024			
623 420 08 38	4335761130	926008	A 389 420 03 38	4335767000	926037			
623 420 09 38	4335761120	926007	A 389 420 04 38	4335767010	926038			
623 420 12 38	4335767100	926045						



AYS Manual Brake Adjusters

AYS Mekanik Fren Ayar Kolları

Patent Number:
Patent No:
2009/09499

Manual Brake Adjusters

Mekanik Fren Ayar Kolları



AYS Manual Brake Adjuster
AYS Mekanik Fren Ayar Kolu

Manual Brake Adjuster
Mekanik Fren Ayar Kolu



PART LIST PARÇA LİSTESİ

- 1 **Body /** Gövde
- 2 **Warm wheel /** Dişli makara
- 3 **Warm screw /** Sonsuz vida
- 4 **Cover plate /** Kapak
- 5 **Rivet /** Perçin
- 6 **Grease nipple /** Grasörlük

Ball Spring

- 7 **Shaft /** Mil
- 8 **Ball /** Bilya
- 9 **Spring /** Yay
- 10 **O-ring /** O-ring

Ball Lock

- 11 **Lock /** Kilit
- 12 **Shaft /** Mil
- 13 **Ball 1 /** Bilya 1
- 14 **Ball 2 /** Bilya 2
- 15 **Spring /** Yay
- 16 **Oring /** Oring
- 17 **Screw /** Seskur

Posi lock

- 18 **Spring /** Yay
- 19 **Lock /** Kilit
- 20 **Shaft /** Mil

AYS Manual / Manual Brake Adjuster

Manual brake adjuster is used in drum brake systems and installed between brake chamber and S-cam shaft. When lining to drum clearance has increased, adjustment should be made manually. This requirement increase service need, out of order time and air consumption of the vehicle. Additionally; if the clearance adjustment is not performed in time, brake security is decreased.

AYS Mekanik / Mekanik Fren Ayar Kolu

Mekanik fren ayar kolu kampana fren sisteminde, hava körüğü ile S- kam mili arasına bağlanır. Fren balataları ile kampana arasındaki boşluğu sabit tutmak için, fren ayar kolunun düzenli aralıklarla ayarlanması gerekir.

Description for AYS Manual Brake Adjuster



AYS - Ball & Spring

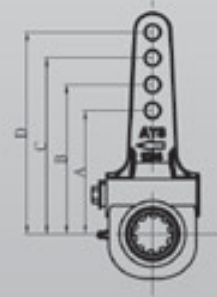

AYS - Posi-Lock



Offset Arm

Description for Manual Brake Adjuster



Ball & Spring



Posi-Lock



Double Arm



Offset Arm



We improved it according to **to road conditions and customer needs**
Yol ve müşteri ihtiyaçlarına göre **geliştiriyoruz.**

Manual Brake Adjuster (Posi-Lock)
Mekanik Fren Ayar Kolu (14'lük)

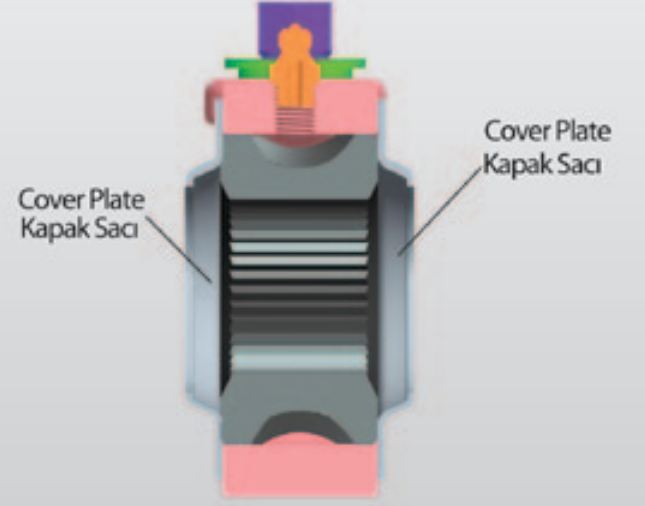
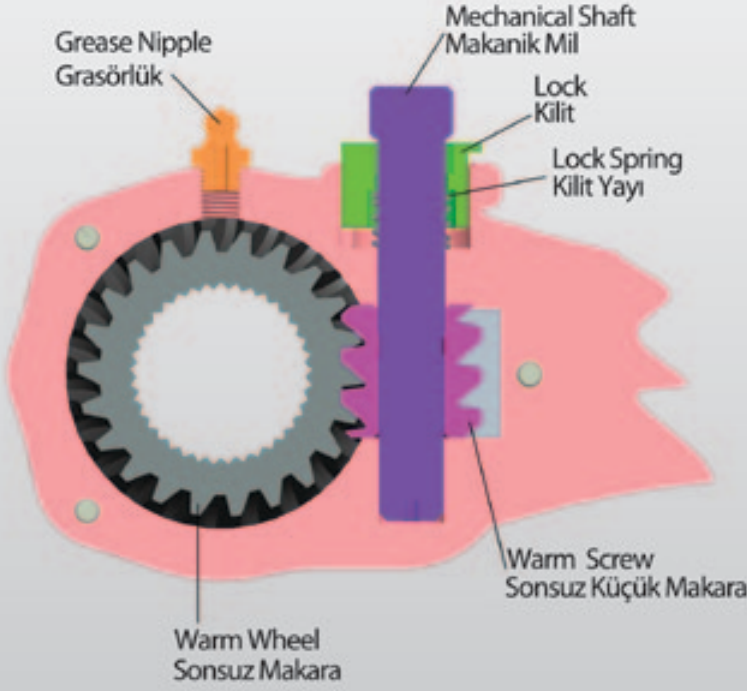

Manual Brake Adjuster (Ball&Spring)
Mekanik Fren Ayar Kolu (19'lük)

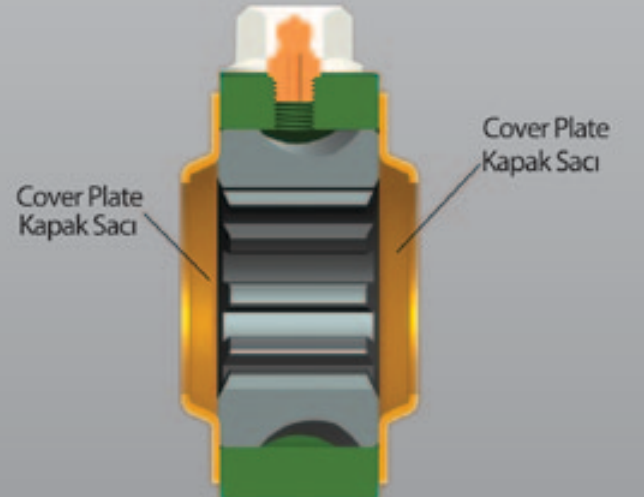
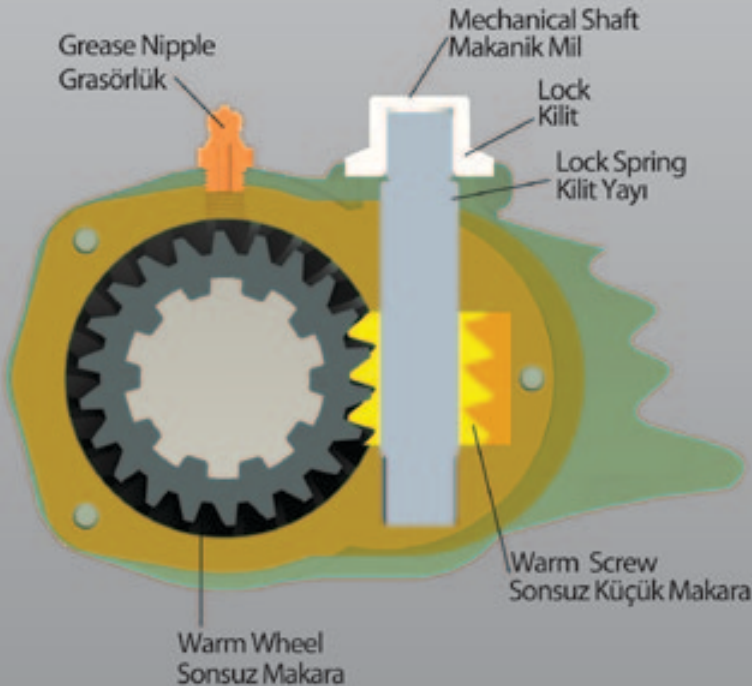

AYS Manual Brake Adjuster (AYS Posi-Lock)
AYS Mekanik Fren Ayar Kolu (AYS 14'lük)

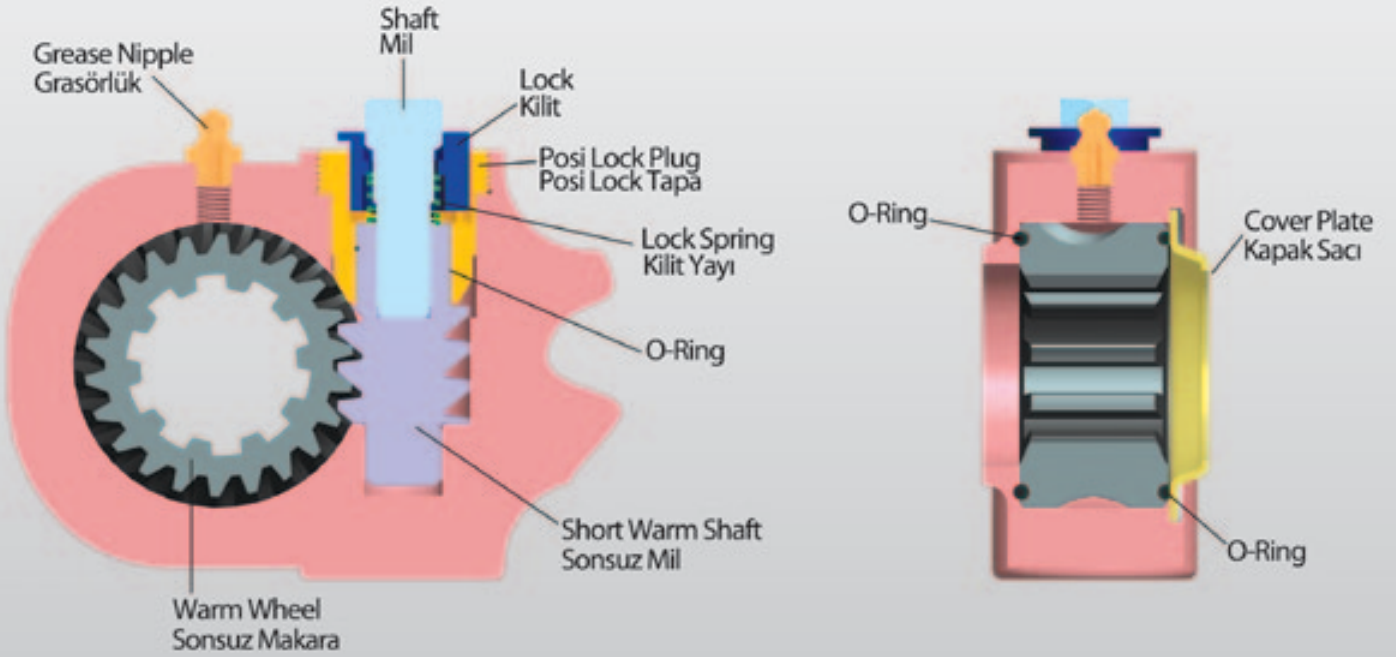

- Improved mono block body.
- Mono-block infinite pin.
- It is provided leakproofing by O-ring for preventing corrosion.

- Geliştirilmiş monoblok gövde.
- Monoblok sonsuz mil.
- Korozyona karşı O-ringlerle sızdırmazlık sağlanmıştır.



AYS Manual Brake Adjuster (AYS Ball&Spring)
AYS Mekanik Fren Ayar Kolu (AYS 19'lük)

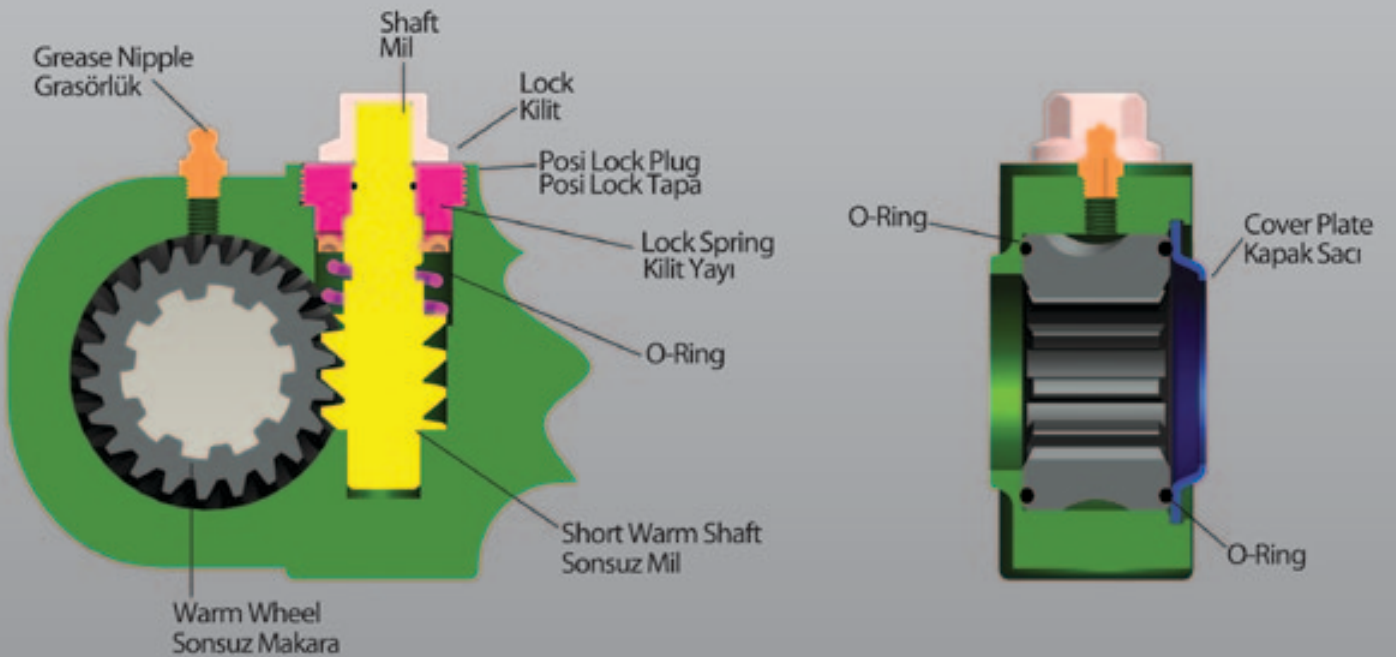

<p>A</p>  <p>1015</p> <p>AYS MANUAL CODE 1041002086</p> <p>PART NUMBER 100101366 OEM NO 218684</p>	<p>B</p>  <p>1018</p> <p>AYS MANUAL CODE 1041002112</p> <p>PART NUMBER 100401204 OEM NO 8446</p>	<p>C</p>  <p>1017</p> <p>AYS MANUAL CODE 1041002113</p> <p>PART NUMBER 100501204 OEM NO 8447</p>
<p>D</p>  <p>1035</p> <p>AYS MANUAL CODE 1041002131</p> <p>PART NUMBER 103020001 OEM NO</p>	<p>E</p>  <p>1034</p> <p>AYS MANUAL CODE 1041002134</p> <p>PART NUMBER 104401401 OEM NO 1465202021</p>	<p>F</p>  <p>1034</p> <p>AYS MANUAL CODE 1041002136</p> <p>PART NUMBER 103021001 OEM NO</p>
<p>G</p>  <p>1035</p> <p>AYS MANUAL CODE 1041002140</p> <p>PART NUMBER 104501401 OEM NO 1465202011</p>	<p>H</p>  <p>Trailers</p> <p>1014</p> <p>AYS MANUAL CODE 1041007022</p> <p>PART NUMBER cs OEM NO</p>	<p>I</p>  <p>DAF (Rear)</p> <p>1014</p> <p>AYS MANUAL CODE 1041007023</p> <p>PART NUMBER cs OEM NO</p>

	AYS MANUAL CODE	CASTING	LEVER TYPE	MECHANISM	APPLICATION	NO. of SPLINE TEETH	NO. of HOLES	A	B	C	D	E	F	G	H	INC.	OFFSET	BUSHING	SPLINE TYPE
A	1041002086	1015	straight	ays-ball&spring		10	1	165										14	SAE 1 1/2"-10 C
B	1041002112	1018	offset	ays-ball&spring	DAF	10	1	140									+38mm	14	SAE 1 1/2"-10 C
C	1041002113	1017	offset	ays-ball&spring	DAF	10	1	140									-38mm	14	SAE 1 1/2"-10 C
D	1041002131	1035	offset	ays-ball&spring		10	1	140								5°	+56mm	14	SAE 1 1/2"-10 C
E	1041002134	1034	offset	ays-ball&spring		10	1	145								5°	-56mm	14	SAE 1 1/2"-10 C
F	1041002136	1034	offset	ays-ball&spring		10	1	140								5°	-56mm	14	SAE 1 1/2"-10 C
G	1041002140	1035	offset	ays-ball&spring		10	1	145								5°	+56mm	14	SAE 1 1/2"-10 C
H	1041007022	1014	straight	ays-ball&spring	Trailers	10	3	127	152	178								x, 12,7	SAE 1 1/2"-10 C
I	1041007023	1014	straight	ays-ball&spring	DAF (Rear)	10	2	127	152									x, 12,7	SAE 1 1/2"-10 C

ROR / TRAILOR 1014



AYS MANUAL CODE **1041007058**
PART NUMBER **100101042**
OEM NO

VOLVO (Right) 1017



AYS MANUAL CODE **1041007118**
PART NUMBER **104501053**
OEM NO **3587**

VOLVO (Left) 1018



AYS MANUAL CODE **1041007119**
PART NUMBER **104401053**
OEM NO **3586**

VOLVO / DAF (Left) 1018



AYS MANUAL CODE **1041007120**
PART NUMBER **104401051**
OEM NO **4469**

VOLVO / DAF (Right) 1017



AYS MANUAL CODE **1041007121**
PART NUMBER **104501051**
OEM NO **4470**

BPW / ROR 1015



AYS MANUAL CODE **1041010068**
PART NUMBER **100001721**
OEM NO **5968**

BPW 1015



AYS MANUAL CODE **1041010071**
PART NUMBER **100001760**
OEM NO **024490**

VOLVO (Left) 1018



AYS MANUAL CODE **1041010114**
PART NUMBER **104401201**
OEM NO **285951**

VOLVO (Right) 1017



AYS MANUAL CODE **1041010115**
PART NUMBER **104501201**
OEM NO **351951**

	AYS MANUAL CODE	CASTING	LEVER TYPE	MECHANISM	APPLICATION	NO. of SPLINE TEETH	NO. of HOLES	A	B	C	D	E	F	G	H	INC.	OFFSET	BUSHING	SPLINE TYPE
A	1041007058	1014	straight	ays-ball&spring	ROR / TRAILOR	10	4	127	152	178	203							x, 12,7	SAE 1 1/2"-10 C
B	1041007118	1017	offset	ays-ball&spring	VOLVO (Right)	10	2	140	165								-38mm	x, 12,7	SAE 1 1/2"-10 C
C	1041007119	1018	offset	ays-ball&spring	VOLVO (Left)	10	2	140	165								+38mm	x, 12,7	SAE 1 1/2"-10 C
D	1041007120	1018	offset	ays-ball&spring	VOLVO / DAF (Left)	10	1	152									+38mm	x, 12,7	SAE 1 1/2"-10 C
E	1041007121	1017	offset	ays-ball&spring	VOLVO / DAF (Right)	10	1	152									-38mm	x, 12,7	SAE 1 1/2"-10 C
F	1041010068	1015	straight	ays-ball&spring	BPW / ROR	10	5	120	150	180	220	250						x, 14	SAE 1 1/2"-10 C
G	1041010071	1015	straight	ays-ball&spring	BPW	10	7	120	135	150	165	180	195	250				x, 14	SAE 1 1/2"-10 C
H	1041010114	1018	offset	ays-ball&spring	VOLVO (Left)	10	1	140									+38mm	x, 14	SAE 1 1/2"-10 C
I	1041010115	1017	offset	ays-ball&spring	VOLVO (Right)	10	1	140									-38mm	x, 14	SAE 1 1/2"-10 C



* INC. > Inclination
* CS > Customer Specific / Özel İmalat

AYS MANUAL BRAKE ADJUSTER TYPES ARE CONTINUOUSLY INCREASED.
PLEASE CONTACT WITH OUR MARKETING DEPARTMENT FOR FURTHER INFORMATIONS.
AYS MEKANİK FREN AYAR KOLLARI SÜREKLİ OLARAK ARTMAKTADIR. DETAYLI BİLGİ İÇİN
PAZARLAMA DEPARTMANI İLE İLETİŞİME GEÇİNİZ.

ALL ORIGINAL NUMBERS, MARKS AND MODELS FROM VEHICLE MANUFACTURERS
LISTED IN THIS CATALOGUE ARE FOR COMPARISON PURPOSES ONLY AND MAY NOT BE
USED IN INVOICES TO VEHICLE OWNERS OR RESELLERS / ORJINAL ÜRÜN NUMARALARI
MÜŞTERİYİ BİLGİLENDİRME VE ÜRÜNE REFERANS AMAÇLI KULLANILMIŞTIR.

<p>BPW 1040</p> <p>A</p>  <p>AYS MANUAL CODE 1041010168</p> <p>PART NUMBER CS</p> <p>OEM NO</p>	<p>SMB 1015</p> <p>B</p>  <p>AYS MANUAL CODE 1041020165</p> <p>PART NUMBER CS</p> <p>OEM NO</p>	<p>VOLVO (Right) 1017</p> <p>C</p>  <p>AYS MANUAL CODE 1041026170</p> <p>PART NUMBER CS</p> <p>OEM NO</p>
<p>VOLVO (Left) 1018</p> <p>D</p>  <p>AYS MANUAL CODE 1041026171</p> <p>PART NUMBER CS</p> <p>OEM NO</p>	<p>1034</p> <p>E</p>  <p>AYS MANUAL CODE 1041910132</p> <p>PART NUMBER 104406401</p> <p>OEM NO 99100340001</p>	<p>1035</p> <p>F</p>  <p>AYS MANUAL CODE 1041910137</p> <p>PART NUMBER 104506401</p> <p>OEM NO 99100340002</p>
<p>D-C (Right) 1034</p> <p>G</p>  <p>AYS MANUAL CODE 1042610132</p> <p>PART NUMBER 104407401</p> <p>OEM NO 6045</p>	<p>D-C (Right) 1034</p> <p>H</p>  <p>AYS MANUAL CODE 1042610135</p> <p>PART NUMBER CS</p> <p>OEM NO 0517458650</p>	<p>D-C (Left) 1035</p> <p>I</p>  <p>AYS MANUAL CODE 1042610137</p> <p>PART NUMBER 104507401</p> <p>OEM NO 6046</p>

	AYS MANUAL CODE	CASTING	LEVER TYPE	MECHANISM	APPLICATION	NO. of SPLINE TEETH	NO. of HOLES	A	B	C	D	E	F	G	H	INC.	OFFSET	BUSHING	SPLINE TYPE
A	1041010168	1040	straight	ays-ball&spring	BPW	10	6	120	135	150	165	180	250					x, 14	SAE 1 1/2"-10 C
B	1041020165	1015	straight	ays-ball&spring	SMB	10	5	105	130	150	180	215						x, 14 (E: x,18)	SAE 1 1/2"-10 C
C	1041026170	1017	offset	ays-ball&spring	VOLVO (Right)	10	1	152									-38mm	x, 16	SAE 1 1/2"-10 C
D	1041026171	1018	offset	ays-ball&spring	VOLVO (Left)	10	1	152									+38mm	x, 16	SAE 1 1/2"-10 C
E	1041910132	1034	offset	ays-ball&spring		19	1	145								5°	-56mm	x, 14	A38x34 DIN 5482
F	1041910137	1035	offset	ays-ball&spring		19	1	145								5°	+56mm	x, 14	A38x34 DIN 5482
G	1042610132	1034	offset	ays-ball&spring	D-C (Right)	26	1	145								5°	-56mm	x, 14	N42x1.5x9H DIN 5480
H	1042610135	1034	offset	ays-ball&spring	D-C (Right)	26	1	145								5°	-56mm	x, 14	N42x1.5x9H DIN 5480
I	1042610137	1035	offset	ays-ball&spring	D-C (Left)	26	1	145								5°	+56mm	x, 14	N42x1.5x9H DIN 5480

D-C (Left) **1035**



A

AYS MANUAL CODE **1042610139**

PART NUMBER **CS**
OEM NO **3854201338**

VOLVO (Right) **1017**



B

AYS MANUAL CODE **1042707118**

PART NUMBER **CS**
OEM NO

VOLVO (Left) **1018**



C

AYS MANUAL CODE **1042707119**

PART NUMBER **CS**
OEM NO

1034



D

AYS MANUAL CODE **1043701133**

PART NUMBER **104414402**
OEM NO

1035



E

AYS MANUAL CODE **1043701138**

PART NUMBER **104514402**
OEM NO

1015



F

AYS MANUAL CODE **1043717067**

PART NUMBER **103019001**
OEM NO

TRAILOR **1015**



G

AYS MANUAL CODE **1043719065**

PART NUMBER **100014753**
OEM NO **106014753**

TRAILER **1014**



H

AYS MANUAL CODE **1050401055**

PART NUMBER **CS**
OEM NO

MERITOR **1014**



I

AYS MANUAL CODE **1052807023**

PART NUMBER **KN44051**
OEM NO

	AYS MANUAL CODE	CASTING	LEVER TYPE	MECHANISM	APPLICATION	NO. of SPLINE TEETH	NO. of HOLES	A	B	C	D	E	F	G	H	INC.	OFFSET	BUSHING	SPLINE TYPE
A	1042610139	1035	offset	ays-ball&spring	D-C (Left)	26	1	145								5°	+56mm	x, 14	N42x1.5x9H DIN 5480
B	1042707118	1017	offset	ays-ball&spring	VOLVO (Right)	27	2	140	165								-38mm	x, 12,7	BNA 227 D3,5
C	1042707119	1018	offset	ays-ball&spring	VOLVO (Left)	27	2	140	165								+38mm	x, 12,7	BNA 227 D3,5
D	1043701133	1034	offset	ays-ball&spring		37	1	145								5°	-56mm	12,7	ANSI B92 1A-1976, 24/48
E	1043701138	1035	offset	ays-ball&spring		37	1	145								5°	+56mm	12,7	ANSI B92 1A-1976, 24/48
F	1043717067	1015	straight	ays-ball&spring		37	5	105	129	151	181	215						x, 14 (E: 16)	ANSI B92 1A-1976, 24/48
G	1043719065	1015	straight	ays-ball&spring	TRAILOR	37	5	105	130	150	180	215						x, 14 (E: x, 16)	ANSI B92 1A-1976, 24/48
H	1050401055	1014	straight	ays-posi-lock	TRAILER	■	4	127	252	178	203							12,7	SQUARE 26,9
I	1052807023	1014	straight	ays-posi-lock	MERITOR	28	2	127	152									x, 12,7	SAE 1 1/2"-28 C



* INC. > Inclination
* CS > Customer Specific / Özel İmalat

AYS MANUAL BRAKE ADJUSTER TYPES ARE CONTINUOUSLY INCREASED.
PLEASE CONTACT WITH OUR MARKETING DEPARTMENT FOR FURTHER INFORMATIONS.
AYS MEKANİK FREN AYAR KOLLARI SÜREKLİ OLARAK ARTMAKTADIR. DETAYLI BİLGİ İÇİN
PAZARLAMA DEPARTMANI İLE İLETİŞİME GEÇİNİZ.

ALL ORIGINAL NUMBERS, MARKS AND MODELS FROM VEHICLE MANUFACTURERS
LISTED IN THIS CATALOGUE ARE FOR COMPARISON PURPOSES ONLY AND MAY NOT BE
USED IN INVOICES TO VEHICLE OWNERS OR RESELLERS / ORJINAL ÜRÜN NUMARALARI
MÜŞTERİYİ BİLGİLENDİRME VE ÜRÜNE REFERANS AMAÇLI KULLANILMIŞTIR.

TECHNICAL LIST

AYS MANUAL CODE	CASTING	LEVER TYPE	MECHANISM	APPLICATION	NO. of SPLINE TEETH	NO. of HOLES	A	B	C	D	E	F	G	H	INC.	OFFSET	BUSHING	SPLINE TYPE
1040801055	1014	straight	ays-ball&spring	Trailers	8	4	127	152	178	203							12,7	32 UNI 222
1040807022	1014	straight	ays-ball&spring		8	3	127	152	178								x, 12,7	32 UNI 222
1040807058	1014	straight	ays-ball&spring	Trailers	8	4	127	152	178	203							x, 12,7	32 UNI 222
1040810020	1014	straight	ays-ball&spring		8	3	126	148	178								x, 14	32 UNI 222
1040810021	1014	straight	ays-ball&spring		8	3	127	152	178								x, 14	32 UNI 222
1040810068	1015	straight	ays-ball&spring		8	5	120	150	180	220	250						x, 14	32 UNI 222
1040810084	1015	straight	ays-ball&spring		8	4	151	181	211	260							x, 14	32 UNI 222
1040810166	1015	straight	ays-ball&spring	CARDI	8	4	152	180	200	225							x, 14	32 UNI 222
1040812097	1016	straight	ays-ball&spring		8	5	152	192	230	260	290						x, 14 (A: x, 8)	32 UNI 222
1040823075	1015	straight	ays-ball&spring		8	5	125	155	180	210	240						x, 14,5	32 UNI 222
1041001024	1014	straight	ays-ball&spring		10	1	127										12,7	SAE 1 1/2"-10 C
1041001030	1014	straight	ays-ball&spring		10	1	140										12,7	SAE 1 1/2"-10 C
1041001036	1014	straight	ays-ball&spring		10	1	159										12,7	SAE 1 1/2"-10 C
1041001047	1014	straight	ays-ball&spring	DAF/ROR	10	4	114	140	165	190,5							12,7	SAE 1 1/2"-10 C
1041001050	1014	straight	ays-ball&spring		10	3	120	140	200								12,7	SAE 1 1/2"-10 C
1041001055	1014	straight	ays-ball&spring	TRAILER-ROR/Trailor	10	4	127	152	178	203							12,7	SAE 1 1/2"-10 C
1041001079	1015	straight	ays-ball&spring		10	5	127	152	178	203	254						12,7	SAE 1 1/2"-10 C
1041002026	1014	straight	ays-ball&spring		10	1	140										14	SAE 1 1/2"-10 C
1041002029	1014	straight	ays-ball&spring		10	2	140	165									14	SAE 1 1/2"-10 C
1041002033	1014	straight	ays-ball&spring		10	1	145										14	SAE 1 1/2"-10 C
1041002046	1014	straight	ays-ball&spring	ROR	10	4	114	140	165	191							14	SAE 1 1/2"-10 C
1041002048	1014	straight	ays-ball&spring	ROR	10	4	115	140	165	190							14	SAE 1 1/2"-10 C
1041002056	1014	straight	ays-ball&spring	ROR/Trailor	10	4	127	152	178	203							14	SAE 1 1/2"-10 C
1041002070	1015	straight	ays-ball&spring		10	6	120	135	150	165	180	250					14	SAE 1 1/2"-10 C
1041002160	1040	straight	ays-ball&spring	BPW	10	6	120	135	150	165	180	250					14	SAE 1 1/2"-10 C
1041003035	1014	straight	ays-ball&spring		10	2	152	178									16	SAE 1 1/2"-10 C
1041005127	1015	straight	ays-ball&spring		10	5	127	152	178	203	250						14 (E: x, 19)	SAE 1 1/2"-10 C
1041007028	1014	straight	ays-ball&spring		10	2	140	165									x, 12,7	SAE 1 1/2"-10 C
1041007034	1014	straight	ays-ball&spring	Trailers	10	2	145	165									x, 12,7	SAE 1 1/2"-10 C
1041010039	1014	straight	ays-ball&spring		10	3	105	130	200								x, 14	SAE 1 1/2"-10 C
1041010040	1014	straight	ays-ball&spring	SAE	10	4	125	150	175	200							x, 14	SAE 1 1/2"-10 C
1041010043	1014	straight	ays-ball&spring		10	4	105	125	150	190							x, 14	SAE 1 1/2"-10 C
1041010045	1014	straight	ays-ball&spring		10	4	105	130	150	200							x, 14	SAE 1 1/2"-10 C
1041010049	1014	straight	ays-ball&spring	BPW/ROR	10	3	120	170	180								x, 14	SAE 1 1/2"-10 C
1041010051	1014	straight	ays-ball&spring		10	3	120	140	200								x, 14	SAE 1 1/2"-10 C
1041010053	1014	straight	ays-ball&spring	ROR/Trailor	10	4	127	152	178	203							x, 14	SAE 1 1/2"-10 C
1041010060	1014	straight	ays-ball&spring	BPW	10	3	150	170	190								x, 14	SAE 1 1/2"-10 C
1041010069	1015	straight	ays-ball&spring		10	6	120	135	150	165	180	250					x, 14	SAE 1 1/2"-10 C
1041010083	1015	straight	ays-ball&spring		10	5	150	180	210	228	260						x, 14	SAE 1 1/2"-10 C
1041010084	1015	straight	ays-ball&spring		10	4	151	181	211	260							x, 14	SAE 1 1/2"-10 C
1041010091	1016	straight	ays-ball&spring	BPW	10	7	120	150	180	200	230	260	290				x, 14	SAE 1 1/2"-10 C
1041011098	1016	straight	ays-ball&spring		10	4	175	230	260	290							x, 14 (A: x, 22)	SAE 1 1/2"-10 C
1041013041	1014	straight	ays-ball&spring		10	3	105	130	200								x, 14 (C: x, 16)	SAE 1 1/2"-10 C
1041013052	1014	straight	ays-ball&spring		10	3	120	140	200								x, 14 (C: x, 16)	SAE 1 1/2"-10 C
1041014077	1015	straight	ays-ball&spring		10	4	127	152	178	220							x, 14 (D: 17)	SAE 1 1/2"-10 C
1041017061	1015	straight	ays-ball&spring		10	5	105	129	153	181	215						x, 14 (E: 16)	SAE 1 1/2"-10 C
1041017062	1015	straight	ays-ball&spring		10	5	105	129	151	181	215						x, 14 (E: 16)	SAE 1 1/2"-10 C
1041018080	1015	straight	ays-ball&spring		10	5	127	152	178	203	248						x, 14 (E: 18)	SAE 1 1/2"-10 C
1041020078	1015	straight	ays-ball&spring	Sauer	10	5	127	152	178	203	230						x, 14 (E: x, 18)	SAE 1 1/2"-10 C
1041022090	1016	straight	ays-ball&spring		10	7	120	150	180	200	230	260	290				x, 14 (G: x, 17)	SAE 1 1/2"-10 C

TECHNICAL LIST













AYS MANUAL CODE	CASTING	LEVER TYPE	MECHANISM	APPLICATION	NO. of SPLINE TEETH	NO. of HOLES	A	B	C	D	E	F	G	H	INC.	OFFSET	BUSHING	SPLINE TYPE
1041023075	1015	straight	ays-ball&spring		10	5	125	155	180	210	240						x, 14,5	SAE 1 1/2"-10 C
1041026054	1014	straight	ays-ball&spring		10	4	127	152	178	203							x, 16	SAE 1 1/2"-10 C
1041027059	1014	straight	ays-ball&spring		10	4	127	152	178	203							x, 17	SAE 1 1/2"-10 C
1041028088	1015	straight	ays-ball&spring		10	1	178										x, 19	SAE 1 1/2"-10 C
1041029027	1014	straight	ays-ball&spring		10	1	140										x, 22	SAE 1 1/2"-10 C
1041407162	1014	straight	ays-ball&spring		14	3	130	155	180								x, 12,7	JIS D 2001 (40x14)
1041910019	1014	straight	ays-ball&spring		19	1	122										x, 14	A38x34 DIN 5482
1041932164	1016	straight	ays-ball&spring		19	3	120	160	290								(A:x,14;B: x,7;C:x,11)	A38x34 DIN 5482
1042010082	1015	straight	ays-ball&spring		20	5	150	175	200	225	250						x, 14	A40x36 DIN 5482
1042010089	1015	straight	ays-ball&spring		20	5	253	228	203	177,5	152,5						x, 14	A40x36 DIN 5482
1042607022	1014	straight	ays-ball&spring	Trailers	26	3	127	152	178								x, 12,7	N42x1.5x9H DIN 5480
1042607058	1014	straight	ays-ball&spring		26	4	127	152	178	203							x, 12,7	N42x1.5x9H DIN 5480
1042625081	1015	straight	ays-ball&spring		26	1	150										x, 15,5	40x1.5 CSN 014950.1
1042710040	1014	straight	ays-ball&spring	Colaert	27	4	125	150	175	200							x, 14	E22-151 BNA 227 ø33
1042710087	1015	straight	ays-ball&spring	Titan	27	4	170	210	240	260							x, 14	E22-151 BNA 227 42x27 x 1.5
1042801025	1014	straight	ays-ball&spring	Meritor	28	2	127	152									12,7	SAE 1 1/2"-28 C
1042801031	1014	straight	ays-ball&spring	Meritor	28	2	140	165									12,7	SAE 1 1/2"-28 C
1042807022	1014	straight	ays-ball&spring	Trailers	28	3	127	152	178								x, 12,7	SAE 1 1/2" 28 C
1042807032	1014	straight	ays-ball&spring		28	1	140										x, 12,7	SAE 1 1/2"-28 C
1042807058	1014	straight	ays-ball&spring	TRAILER	28	4	127	152	178	203							x, 12,7	SAE 1 1/2"-28 C
1043701055	1014	straight	ays-ball&spring	Trailer	37	4	127	152	178	203							12,7	ANSI B92 1A-1976, 24/48
1043704063	1015	straight	ays-ball&spring		37	4	105	130	150	215							12,7 (D: 16)	ANSI B92 1A-1976, 24/48
1043707022	1014	straight	ays-ball&spring		37	3	127	152	178								x, 12,7	ANSI B92 1A-1976, 24/48
1043707058	1014	straight	ays-ball&spring	Fruehauf	37	4	127	152	178	203							x, 12,7	ANSI B92 1A-1976, 24/48
1043710095	1016	straight	ays-ball&spring	Kässbohrer	37	7	120	150	180	200	230	260	290				x, 14	A36x40 DIN 5481
1043715072	1015	straight	ays-ball&spring		37	4	120	150	180	230							x, 14 (D: x, 18)	A36x40 DIN 5481
1043715093	1016	straight	ays-ball&spring	Kässbohrer	37	4	120	150	180	290							x, 14 (D: x, 18)	A36x40 DIN 5481
1043716076	1015	straight	ays-ball&spring		37	4	125	150	180	210							x, 14 (D: x, 19)	SAE J 498
1043719066	1015	straight	ays-ball&spring	Propar/Fruehauf	37	5	105	130	150	180	206						x, 14 (E: x, 16)	ANSI B92 1A-1976, 24/48
1043720064	1015	straight	ays-ball&spring	Fruehauf	37	5	105	130	150	180	215						x, 14 (E: x, 18)	ANSI B92 1A-1976, 24/48
1043721094	1016	straight	ays-ball&spring		37	6	120	135	150	165	180	290					x, 14 (F: x, 18)	A36x40 DIN 5481
1043731161	1015	straight	ays-ball&spring	Fruehauf	37	5	105	130	150	180	215						x, 16 (E: x, 19)	ANSI B92 1A-1976, 24/48
1043810053	1014	straight	ays-ball&spring	ROR/Trailer	38	4	127	152	178	203							x, 14	
1043910037	1014	straight	ays-ball&spring		39	2	170	190									x, 14	E22-151 BNA 227 30x39 x 0.75
1043910042	1014	straight	ays-ball&spring		39	3	105	125	150								x, 14	E22-151 BNA 227 30x39 x 0.75
1043910044	1014	straight	ays-ball&spring		39	5	105	125	150	170	190						x, 14	E22-151 BNA 227 30x39 x 0.75
1051001055	1014	straight	ays-posi-lock	TRAILER	10	4	127	152	178	203							12,7	SAE 1 1/2"-10 C
1051005127	1015	straight	ays-posi-lock	Premium mega plus	10	5	127	152	178	203	250						14 (E: x, 19)	SAE 1 1/2"-10 C
1051007022	1014	straight	ays-posi-lock	Trailers	10	3	127	152	178								x, 12,7	SAE 1 1/2"-10 C
1051007023	1014	straight	ays-posi-lock	Daf rear	10	2	127	152									x, 12,7	SAE 1 1/2"-10 C
1051010053	1014	straight	ays-posi-lock	ROR/Trailer	10	4	127	152	178	203							x, 14	SAE 1 1/2"-10 C
1051010071	1015	straight	ays-posi-lock	BPW	10	7	120	135	150	165	180	195	250				x, 14	SAE 1 1/2"-10 C
1051010091	1016	straight	ays-posi-lock	BPW	10	7	120	150	180	200	230	260	290				x, 14	SAE 1 1/2"-10 C
1052010089	1015	straight	ays-posi-lock		20	5	253	228	203	177,5	152,5						x, 14	A40x36 DIN 5482
1052801055	1014	straight	ays-posi-lock	TRAILER	28	4	127	152	178	203							12,7	SAE 1 1/2"-28 C
1052807022	1014	straight	ays-posi-lock	Trailers	28	3	127	152	178								x, 12,7	SAE 1 1/2"-28 C
1052807167	1014	straight	ays-posi-lock	Meritor	28	2	140	165									x, 12,7	SAE 1 1/2"-28 C
1053701055	1014	straight	ays-posi-lock	TRAILER	37	4	127	152	178	203							12,7	ANSI B92 1A-1976, 24/48
1053707022	1014	straight	ays-posi-lock		37	3	127	152	178								x, 12,7	ANSI B92 1A-1976, 24/48
1053720064	1015	straight	ays-posi-lock	Fruehauf	37	5	105	130	150	180	215						x, 14 (E: x, 18)	ANSI B92 1A-1976, 24/48



* INC. > Inclination
* CS > Customer Specific / Özel İmalat

AYS MANUAL BRAKE ADJUSTER TYPES ARE CONTINUOUSLY INCREASED.
PLEASE CONTACT WITH OUR MARKETING DEPARTMENT FOR FURTHER INFORMATIONS.
AYS MEKANİK FREN AYAR KOLLARI SÜREKLİ OLARAK ARTMAKTADIR. DETAYLI BİLGİ İÇİN
PAZARLAMA DEPARTMANI İLE İLETİŞİME GEÇİNİZ.

ALL ORIGINAL NUMBERS, MARKS AND MODELS FROM VEHICLE MANUFACTURERS
LISTED IN THIS CATALOGUE ARE FOR COMPARISON PURPOSES ONLY AND MAY NOT BE
USED IN INVOICES TO VEHICLE OWNERS OR RESELLERS / ORJINAL ÜRÜN NUMARALARI
MÜŞTERİYİ BİLGİLENDİRME VE ÜRÜNE REFERANS AMAÇLI KULLANILMIŞTIR.

VOLVO FRONT (Left) A 	1228 AYS CODE 110114 PART NUMBER 104401032 OEM NO 1501307	SCANIA (Left) B 	1231 AYS CODE 110122 PART NUMBER CS OEM NO	SCANIA (Right) C 	1230 AYS CODE 110123 PART NUMBER CS OEM NO 265026
SCANIA (Left) D 	1231 AYS CODE 110124 PART NUMBER CS OEM NO 278736	SCANIA (Right) E 	9083 AYS CODE 110125 PART NUMBER CS OEM NO	IKARUS (Left) F 	9083 AYS CODE 110126 PART NUMBER CS OEM NO
IKARUS (Right) G 	9083 AYS CODE 110127 PART NUMBER CS OEM NO	IKARUS (Left) H 	9083 AYS CODE 110128 PART NUMBER CS OEM NO	RIGHT I 	9049 AYS CODE 110129 PART NUMBER CS OEM NO
LEFT J 	9049 AYS CODE 110130 PART NUMBER CS OEM NO	SCANIA TRUCK-BUS (Right) K 	1237 AYS CODE 110131 PART NUMBER CS OEM NO 1448120	SCANIA TRUCK-BUS (Left) L 	1238 AYS CODE 110132 PART NUMBER CS OEM NO 1448121

	AYS CODE	CASTING	LEVER TYPE	MECHANISM	APPLICATION	NO. of SPLINE TEETH	NO. of HOLES	A	B	C	D	E	F	G	H	INC.	OFFSET	BUSHING	SPLINE TYPE
A	110114	1228	offset	ball & spring	VOLVO FRONT (Left)	10	1	140									+12.7mm	x, 12,7	SAE 1 1/2"-10 C
B	110122	1231	offset	posi-lock	SCANIA (Left)	10	1	165								31°	+25mm	14	SAE 1 1/2"-10 C
C	110123	1230	offset	posi-lock	SCANIA (Right)	10	1	165								31°	-25mm	16	SAE 1 1/2"-10 C
D	110124	1231	offset	posi-lock	SCANIA (Left)	10	1	165								31°	+25mm	16	SAE 1 1/2"-10 C
E	110125	9083	offset	posi-lock	SCANIA (Right)	10	1	177,5									-60mm	x, 12	SAE 1 1/2"-10 C
F	110126	9083	offset	posi-lock	IKARUS (Left)	10	1	177,5									+60mm	x, 12	SAE 1 1/2"-10 C
G	110127	9083	offset	ball & spring	IKARUS (Right)	10	1	177,5									-60mm	x, 12	SAE 1 1/2"-10 C
H	110128	9083	offset	ball & spring	IKARUS (Left)	10	1	177,5									+60mm	x, 12	SAE 1 1/2"-10 C
I	110129	9049	offset	posi-lock	RIGHT	10	1	150									-35mm	x, 16	SAE 1 1/2"-10 C
J	110130	9049	offset	posi-lock	LEFT	10	1	150									+35mm	x, 16	SAE 1 1/2"-10 C
K	110131	1237	offset	posi-lock	SCANIA TRUCK BUS (Right)	10	1	162									-61mm	x, 16	SAE 1 1/2"-10 C
L	110132	1238	offset	posi-lock	SCANIA TRUCK BUS (Left)	10	1	162									+61mm	x, 16	SAE 1 1/2"-10 C

SCANIA (right) 9083  A	9083 AYS CODE 110133 PART NUMBER CS OEM NO 276517	SCANIA (Right) 9083  B	9083 AYS CODE 110134 PART NUMBER CS OEM NO 276518	SCANIA 1209  C	1209 AYS CODE 110135 PART NUMBER CS OEM NO 278734
SCANIA (93-112) 1209  D	1209 AYS CODE 110136 PART NUMBER CS OEM NO 295567	SCANIA (Right) 1230  E	1230 AYS CODE 110137 PART NUMBER CS OEM NO 267026	SCANIA (Left) 1231  F	1231 AYS CODE 110138 PART NUMBER CS OEM NO 267027
D-C 1229  G	1229 AYS CODE 119104 PART NUMBER CS OEM NO	DAF FRONT (Right) 1210  H	1210 AYS CODE 120100 PART NUMBER CS OEM NO	DAF FRONT (Left) 1211  I	1211 AYS CODE 120200 PART NUMBER CS OEM NO
IKARUS 1242  J	1242 AYS CODE 120101 PART NUMBER CS OEM NO	IKARUS 1243  K	1243 AYS CODE 120102 PART NUMBER CS OEM NO	IKARUS 1219  L	1219 AYS CODE 120103 PART NUMBER CS OEM NO







	AYS CODE	CASTING	LEVER TYPE	MECHANISM	APPLICATION	NO. of SPLINE TEETH	NO. of HOLES	A	B	C	D	E	F	G	H	INC.	OFFSET	BUSHING	SPLINE TYPE
A	110133	9083	offset	posi-lock	SCANIA (right)	10	1	165									-60mm	x, 16	SAE 1 1/2"-10 C
B	110134	9083	offset	posi-lock	SCANIA (Right)	10	1	165									+60mm	x, 16	SAE 1 1/2"-10 C
C	110135	1209	straight	posi-lock	SCANIA	10	1	165								30°		x, 16	SAE 1 1/2"-10 C
D	110136	1209	straight	ball & spring	SCANIA (93-112)	10	1	165								30°		16	SAE 1 1/2"-10 C
E	110137	1230	offset	ball & spring	SCANIA (Right)	10	1	165								31°	-25mm	16	SAE 1 1/2"-10 C
F	110138	1231	offset	ball & spring	SCANIA (Left)	10	1	165								31°	+25mm	16	SAE 1 1/2"-10 C
G	119104	1229	straight	ball & spring	D-C	19	1	130								30°		14	A38x34 DIN 5482
H	120100	1210	offset	posi-lock	DAF FRONT (Right)	10	2	130	156								-26mm	x, 12,7	SAE 1 1/2"-10 C
I	120200	1211	offset	posi-lock	DAF FRONT (Left)	10	2	130	156								+26mm	x, 12,7	SAE 1 1/2"-10 C
J	120101	1242	straight	ball	IKARUS	20	1	155										x, 14	A40x36 DIN 5482
K	120102	1243	straight	ball	IKARUS	20	1	155										x, 14,7	A40x36 DIN 5482
L	120103	1219	straight	ball	IKARUS	20	1	155,7										x, 14,5	A40x36 DIN 5482















* INC. > Inclination
* CS > Customer Specific / Özel İmalat

AYS MANUAL BRAKE ADJUSTER TYPES ARE CONTINUOUSLY INCREASED.
PLEASE CONTACT WITH OUR MARKETING DEPARTMENT FOR FURTHER INFORMATIONS.
AYS MEKANİK FREN AYAR KOLLARI SÜREKLİ OLARAK ARTMAKTADIR. DETAYLI BİLGİ İÇİN
PAZARLAMA DEPARTMANI İLE İLETİŞİME GEÇİNİZ.

ALL ORIGINAL NUMBERS, MARKS AND MODELS FROM VEHICLE MANUFACTURERS
LISTED IN THIS CATALOGUE ARE FOR COMPARISON PURPOSES ONLY AND MAY NOT BE
USED IN INVOICES TO VEHICLE OWNERS OR RESELLERS / ORJINAL ÜRÜN NUMARALARI
MÜŞTERİYİ BİLGİLENDİRME VE ÜRÜNE REFERANS AMAÇLI KULLANILMIŞTIR.

IKARUS (Right) 	1220 AYS CODE 120201 PART NUMBER CS OEM NO	IKARUS (Left) 	1221 AYS CODE 120202 PART NUMBER CS OEM NO	IKARUS (Right) 	1223 AYS CODE 120203 PART NUMBER CS OEM NO
IKARUS (Left) 	1224 AYS CODE 120204 PART NUMBER CS OEM NO	IKARUS (Right) 	1225 AYS CODE 120205 PART NUMBER CS OEM NO	IKARUS (Left) 	1226 AYS CODE 120206 PART NUMBER CS OEM NO
IKARUS 	9000 AYS CODE 120207 PART NUMBER CS OEM NO	IKARUS 	9000 AYS CODE 120208 PART NUMBER CS OEM NO	DAEWOO 	1237 AYS CODE 125100 PART NUMBER CS OEM NO
DAEWOO 	1238 AYS CODE 125101 PART NUMBER CS OEM NO	IKARUS 	9083 AYS CODE 125102 PART NUMBER CS OEM NO	DAEWOO 	9083 AYS CODE 125103 PART NUMBER CS OEM NO

	AYS CODE	CASTING	LEVER TYPE	MECHANISM	APPLICATION	NO. of SPLINE TEETH	NO. of HOLES	A	B	C	D	E	F	G	H	INC.	OFFSET	BUSHING	SPLINE TYPE
A	120201	1220	offset	ball	IKARUS (Right)	20	2	176	256								-65mm	x, 12,7 (A: x, 8)	A40x36 DIN 5482
B	120202	1221	offset	ball	IKARUS (Left)	20	2	176	256								+65mm	x, 12,7 (A: x, 8)	A40x36 DIN 5482
C	120203	1223	offset		IKARUS (Right)	36	1	277								5°	-142,6mm	x. 15	A30x34 DIN 5481
D	120204	1224	offset		IKARUS (Left)	36	1	277								5°	+142,6mm	x. 15	A30x34 DIN 5481
E	120205	1225	offset		IKARUS (Right)	36	1	140									+30,4mm	x, 14	A30x34 DIN 5481
F	120206	1226	offset		IKARUS (Left)	36	1	140									-30,4mm	x, 14	A30x34 DIN 5481
G	120207	9000	straight	posi-lock	IKARUS	20	2	157	176									x, 14	A40x36 DIN 5482
H	120208	9000	straight	ball & spring	IKARUS	20	2	157	176									x, 14	A40x36 DIN 5482
I	125100	1237	offset	ball & spring	DAEWOO	25	1	150									-61mm	x, 16	JIS B 1602
J	125101	1238	offset	ball & spring	DAEWOO	25	1	150									+61mm	x, 16	JIS B 1602
K	125102	9083	offset	posi-lock		25	1	145									-60mm	x, 16	JIS B 1602
L	125103	9083	offset	posi-lock		25	1	145									+60mm	x, 16	JIS B 1602

MERCEDES  1236 AYS CODE 126103 PART NUMBER CS OEM NO 0004200438	RENAULT (Right)  1320 AYS CODE 132000 PART NUMBER CS OEM NO 5000716831	RENAULT (Left)  1321 AYS CODE 132001 PART NUMBER CS OEM NO 5000716830
FAB FAMOS (Right)  1232 AYS CODE 138000 PART NUMBER CS OEM NO	FAB FAMOS (Left)  1233 AYS CODE 138001 PART NUMBER CS OEM NO	SCANIA FRONT (Right)  1237 AYS CODE 140100 PART NUMBER CS OEM NO
SCANIA FRONT (Left)  1238 AYS CODE 140200 PART NUMBER CS OEM NO	93.112 SCANIA TRACTIVE  1209 AYS CODE 140400 PART NUMBER CS OEM NO	VOLVO FRONT (Right)  1227 AYS CODE 150100 PART NUMBER CS OEM NO
VOLVO FRONT (Left)  1228 AYS CODE 150200 PART NUMBER CS OEM NO 1501307	Mercedes (Right)  1203 AYS CODE 160300 PART NUMBER CS OEM NO	Mercedes (Left)  1204 AYS CODE 160400 PART NUMBER CS OEM NO

	AYS CODE	CASTING	LEVER TYPE	MECHANISM	APPLICATION	NO. of SPLINE TEETH	NO. of HOLES	A	B	C	D	E	F	G	H	INC.	OFFSET	BUSHING	SPLINE TYPE
A	126103	1236	straight	ball & spring	MERCEDES	26	1	145								30°		x, 14	N42x1.5x9H DIN 5480
B	132000	1320	offset		RENAULT (Right)	27	2	184	270								-126mm	x, 14	BNA 227 D3.5
C	132001	1321	offset		RENAULT (Left)	27	2	184	270								+126mm	x, 14	BNA 227 D3.5
D	138000	1232	offset	ball&lock	FAB FAMOS (Right)	26	1	114								5°	-30,8mm	14	N42x1.5x9H DIN 5480
E	138001	1233	offset	ball&lock	FAB FAMOS (Left)	26	1	114								5°	+30,8mm	14	N42x1.5x9H DIN 5480
F	140100	1237	offset	posi-lock	SCANIA FRONT (Right)	10	1	160									-61mm	x, 12,7	SAE 1 1/2"-10 C
G	140200	1238	offset	posi-lock	SCANIA FRONT (Left)	10	1	160									+61mm	x, 12,7	SAE 1 1/2"-10 C
H	140400	1209	straight	posi-lock	93.112 SCANIA TRACTIVE	10	1	165								30°		x, 14	SAE 1 1/2"-10 C
I	150100	1227	offset	posi-lock	VOLVO FRONT (Right)	10	1	140									-13mm	x, 12,7	SAE 1 1/2"-10 C
J	150200	1228	offset	posi-lock	VOLVO FRONT (Left)	10	1	140									+13mm	x, 12,7	SAE 1 1/2"-10 C
K	160300	1203	offset	posi-lock	Mercedes (Right)	26	1	139									100mm	x, 12,7	N42x1.5x9H DIN 5480
L	160400	1204	offset	posi-lock	Mercedes (Left)	26	1	139									+100mm	x, 12,7	N42x1.5x9H DIN 5480



* INC. > Inclination
 * CS > Customer Specific / Özel İmalat

AYS MANUAL BRAKE ADJUSTER TYPES ARE CONTINUOUSLY INCREASED.
 PLEASE CONTACT WITH OUR MARKETING DEPARTMENT FOR FURTHER INFORMATIONS.
 AYS MEKANİK FREN AYAR KOLLARI SÜREKLİ OLARAK ARTMAKTADIR. DETAYLI BİLGİ İÇİN
 PAZARLAMA DEPARTMANI İLE İLETİŞİME GEÇİNİZ.

ALL ORIGINAL NUMBERS, MARKS AND MODELS FROM VEHICLE MANUFACTURERS
 LISTED IN THIS CATALOGUE ARE FOR COMPARISON PURPOSES ONLY AND MAY NOT BE
 USED IN INVOICES TO VEHICLE OWNERS OR RESELLERS / ORJINAL ÜRÜN NUMARALARI
 MÜŞTERİYİ BİLGİLENDİRME VE ÜRÜNE REFERANS AMAÇLI KULLANILMIŞTIR.

TECHNICAL LIST

AYS CODE	CASTING	LEVER TYPE	MECHANISM	APPLICATION	NO. of SPLINE TEETH	NO. of HOLES	A	B	C	D	E	F	G	H	INC.	OFFSET	BUSHING	SPLINE TYPE
110121	1239	straight	posi-lock	Scania rear	10	1	154										12,7	SAE 1 1/2"-10 C
110308		double arm	posi-lock		10	3	120	140						200			x, 14 (H: 16)	SAE 1 1/2"-10 C
110311	1013	offset	posi-lock	CAT (right)	8	3	230	260	290							-9,5mm	x, 12,7 (C: x, 14)	32 UNI 222
110312	1013	offset	posi-lock	CAT (left)	8	3	230	260	290							+9,5mm	x, 12,7 (C: x, 14)	32 UNI 222
110504		double arm	posi-lock	Trailer	10	5	127	152	178	203				190,5			1/2" (H: 17/32")	SAE 1 1/2"-10 C
110505		double arm	posi-lock		10	5	127	152	178	203				191			x, 14 (H: 17/32")	SAE 1 1/2"-10 C
111210	1014	straight	posi-lock		27	3	127	152	178								12,7	BNA 227 D3.5
119100	1244	offset	posi-lock	BPW	19	1	180									+58mm	14	A38x34 DIN 5482
119200	1240	straight	ball & spring		19	1	105							85			(H1:x, 14; H7:x, 12)	A38x34 DIN 5482
119201	1240	straight	ball & spring		19	1	105							85			(H1:x, 14; H7:x, 12)	A38x34 DIN 5482
124100	1014	straight	ball & spring		24	1	127										x, 12,7	SAE 1 1/4" 24 C
126102	1229	straight	ball & spring	D-C	26	1	130								30°		14	N42x1.5x9H DIN 5480
130100	1207	offset	posi-lock	697 fiat front (right)	8	1	150									-39mm	x, 12,7	32 UNI 222
130200	1208	offset	posi-lock	697 fiat front (left)	8	1	150									+39mm	x, 12,7	32 UNI 222
130300	1205	offset	posi-lock	697 fiat rear (right)	8	1	172									-39mm	x, 12,7	32 UNI 222
130400	1206	offset	posi-lock	697 fiat rear (left)	8	1	172									+39mm	x, 12,7	32 UNI 222
130500	1201	offset	posi-lock	169 fiat tractive (right)	8	2	163	187								-23mm	x, 13	32 UNI 222
130600	1202	offset	posi-lock	169 fiat tractive (left)	8	2	163	187								+23mm	x, 13	32 UNI 222
137403		double arm	posi-lock		37	4	105	130	150					165			x, 14 (H: 16.5)	ANSI B92 1A-1976, 24/48
137404		double arm	posi-lock		37	4	105	130	150					200			x, 14 (H: 16)	ANSI B92 1A-1976, 24/48
140300	1239	straight	posi-lock	Scania tractive	10	2	141	165									x, 14	SAE 1 1/2"-10 C

AYS CODE - AYS MANUAL CODE - PART NUMBER LIST

AYS CODE	AYS MANUAL CODE	PART NUMBER	PAGE NO	AYS CODE	AYS MANUAL CODE	PART NUMBER	PAGE NO	AYS CODE	AYS MANUAL CODE	PART NUMBER	PAGE NO
108300	1040810021	100016970	236	110410	1041001055	100101072	236	126400	1042607058	cs	237
108301	1040810020	103005001	236	110411	1041001055	102060001	236	127200	1042707118	cs	235
108302	1040807022	cs	236	110412	1041001047	102060031	236	127201	1042707119	cs	235
108400	1040807058	cs	236	110413	1041002056	102172001	236	127400	1042710087	100213749	237
108500	1040812097	100016170	236	110414	1041002048	102172031	236	127401	1042710040	100215921	237
108501	1040810068	103004001	236	110415	1041010045	102315271	236	127402	1042710087	100313749	237
110100	1041007023	cs	232	110416	1041001055	103006001	236	127403	1042710040	100315921	237
110101	1041002033	100101006	236	110416	1041007058		233	128100	1042807032	cs	237
110102	1041001030	100101009	236	110417	1041002056	103007001	236	128200	1042801025	KN44051	237
110103	1041002026	100101364	236	110418	1041014077	103012001	236	128200	1052807023	KN44051	235
110104	1041029027	100101365	237	110419	1041027059	103013001	237	128201	1042801031	KN44061	237
110105	1041002086	100101366	232	110420	1041026054	cs	237	128201	1052807167	KN44061	237
110106	1041002026	100101367	236	110500	1040807058	cs	236	137100	1043701133	104414402	235
110107	1041002112	100401204	232	110501	1041010068	100001721	233	137101	1043701138	104514402	235
110108	1041002113	100501204	232	110502	1041010068	100101741	233	137400	1043715093	100002166	237
110109	1041001036	102904281	236	110503	1041020078	100101743	236	137401	1043715072	100002568	237
110110	1041001030	102925111	236	110506	1041001079	103003001	236	137402	1043701055	102066001	237
110111	1041001024	102925394	236	110507	1041018080	103014001	236	137402	1043707058		237
110112	1041002131	103020001	232	110508	1041017061	103017001	236	137405	1043704063	103009001	237
110113	1041002136	103021001	232	110509	1041017062	103018001	236	137406	1043716076	cs	237
110114		104401032	238	110510	1041005127	cs	236	137407	1043707058	cs	237
110115	1041007120	104401051	233	110600	1041007058	100101042	233	137500	1043720064	100014750	237
110116	1041010114	104401201	233	110601	1041010069	cs	236	137501	1043719065	100014753	235
110117	1041002134	104401401	232	110602	1041010069	cs	236	137502	1043719066	100114075	237
110118	1041007121	104501051	233	110603	1041002070	cs	236	137503	1043717067	103019001	235
110119	1041010115	104501201	233	110700	1043707058	cs	237	137600	1043721094	100002167	237
110120	1041002140	104501401	232	110701	1041022090	100001122	236	137601	1043721096	cs	
110139	1041026170	cs	234	110702	1041010091	100001125	236	137700	1043710095	100002163	237
110140	1041026171	cs	234	110703	1041010071	1000011760	233	139000		103015001	
110200	1051007022	cs	237	110704	1041010091	100101145	236	139200	1043910037	100012346	237
110200	1041007022	cs	232	110705	1041010071	103010001	233	139300	1043910042	100012901	237
110201	1041007028	100001023	236	110706	1041010071	cs	233	139400	1041010043	cs	236
110202	1041003035	100101007	236	110800	1040810084	cs	236	139500	1043910044	100012345	237
110203	1041002029	103011001	236	110801	1042010089	cs	237	150300	1041007118	cs	233
110204	1041007119	104401053	233	110801	1052010089	cs	237	150400	1041007119	cs	233
110205	1041007118	104501053	233	110802	1040823075	cs	236	160100	1042610132	cs	234
110206	1041007034	cs	236	110803	1041010083	cs	236	160200	1042610137	cs	234
110300	1041007022	cs	232	110804	1042625081	cs	237	cs	1041002160	cs	236
110301	1041010049	100001021	236	110805	1041010084	cs	236	cs	1043731161	cs	237
110302	1041010060	100001025	236	110806	1041023075	cs	237	cs	1051007022	cs	237
110303	1041010049	100101041	236	110807	1040810084	cs	236	cs	1050401055	cs	235
110304	1041010060	100101045	236	110900	1040807058	cs	236	cs	1051001055	cs	237
110305	1041001050	102060291	236	110901	1040801055	cs	236	cs	1052801055	cs	237
110306	1041010051	102315291	236	110901	1040807058	cs	236	cs	1053701055	cs	237
110307	1041010039	102315341	236	111000	1042607022	cs	237	cs	1043707022	cs	237
110309	1041013052	102922291	236	111100	1042807022	cs	237	cs	1051010053	cs	237
110310	1041013041	102923341	236	111200	1042607022	cs	237	cs	1053720064	cs	237
110400	1042807022	cs	237	111300	1041028088	cs	237	cs	1051005127	cs	237
110400	1052807022	cs	237	119101	1041910019	100106005	237	cs	1051010071	cs	237
110401	1041010053	100001027	236	119102	1041910132	104406401	234	cs	1042807058	cs	237
110402	1041010040	100001030	236	119103	1041910137	104506401	234	cs	1043810053	cs	237
110403	1041011098	100001128	236	119300	1041932164	cs	237	cs	1041407162	cs	237
110404	1041026054	100101003	237	120300	1041007023	cs	232	cs	1041020165	cs	234
110405	1041002056	100101008	236	120300	1051007023	cs	237	cs	1040810166	cs	236
110405	1041010053		236	120500	1042010082	103016001	237	cs	1051010091	cs	237
110406	1041007058	100101042	233	126100	1042610132	104407401	234	cs	1053707022	cs	237
110407	1041010053	100101047	236	126101	1042610137	104507401	234	cs	1041010168	cs	234
110408	1041002056	100101070	236	126104	1042610135	cs	234				
110409	1041002046	100101071	236	126105	1042610139	cs	235				

PART NUMBER - AYS CODE - AYS MANUAL CODE LIST

PART NUMBER	AYS CODE	AYS MANUAL CODE	PAGE NO	PART NUMBER	AYS CODE	AYS MANUAL CODE	PAGE NO	PART NUMBER	AYS CODE	AYS MANUAL CODE	PAGE NO
100001021	110301	1041010049	236	102922291	110309	1041013052	236	cs	110706	1041010071	233
100001023	110201	1041007028	236	102923341	110310	1041013041	236	cs	110800	1040810084	236
100001025	110302	1041010060	236	102925111	110110	1041001030	236	cs	110801	1042010089	237
100001027	110401	1041010053	236	102925394	110111	1041001024	236	cs	110801	1052010089	237
100001030	110402	1041010040	236	103003001	110506	1041001079	236	cs	110802	1040823075	236
100001122	110701	1041022090	236	103004001	108501	1040810068	236	cs	110803	1041010083	236
100001125	110702	1041010091	236	103005001	108301	1040810020	236	cs	110804	1042625081	237
100001128	110403	1041011098	236	103006001	110416	1041001055	236	cs	110805	1041010084	236
100001721	110501	1041010068	233	103007001	110417	1041002056	236	cs	110806	1041023075	237
100001760	110703	1041010071	233	103009001	137405	1043704063	237	cs	110807	1040810084	236
100002163	137700	1043710095	237	103010001	110705	1041010071	233	cs	110900	1040807058	236
100002166	137400	1043715093	237	103011001	110203	1041002029	236	cs	110901	1040801055	236
100002167	137600	1043721094	237	103012001	110418	1041014077	236	cs	110901	1040807058	236
100002568	137401	1043715072	237	103013001	110419	1041027059	237	cs	111000	1042607022	237
100012345	139500	1043910044	237	103014001	110507	1041018080	236	cs	111100	1042807022	237
100012346	139200	1043910037	237	103015001	139000			cs	111200	1042607022	237
100012901	139300	1043910042	237	103016001	120500	1042010082	237	cs	111300	1041028088	237
100014750	137500	1043720064	237	103017001	110508	1041017061	236	cs	119300	1041932164	237
100014753	137501	1043719065	235	103018001	110509	1041017062	236	cs	120300	1041007023	232
100016170	108500	1040812097	236	103019001	137503	1043717067	235	cs	120300	1051007023	237
100016970	108300	1040810021	236	103020001	110112	1041002131	232	cs	126104	1042610135	234
100101003	110404	1041026054	237	103021001	110113	1041002136	232	cs	126105	1042610139	235
100101006	110101	1041002033	236	104401032	110114		238	cs	126400	1042607058	237
100101007	110202	1041003035	236	104401051	110115	1041007120	233	cs	127200	1042707118	235
100101008	110405	1041002056	236	104401053	110204	1041007119	233	cs	127201	1042707119	235
100101009	110102	1041001030	236	104401201	110116	1041010114	233	cs	128100	1042807032	237
100101041	110303	1041010049	236	104401401	110117	1041002134	232	cs	137406	1043716076	237
100101042	110406	1041007058	233	104406401	119102	1041910132	234	cs	137407	1043707058	237
100101042	110600	1041007058	233	104407401	126100	1042610132	234	cs	137601	1043721096	
100101045	110304	1041010060	236	104414402	137100	1043701133	235	cs	139400	1041010043	236
100101047	110407	1041010053	236	104501051	110118	1041007121	233	cs	150300	1041007118	233
100101070	110408	1041002056	236	104501053	110205	1041007118	233	cs	150400	1041007119	233
100101071	110409	1041002046	236	104501201	110119	1041010115	233	cs	160100	1042610132	234
100101072	110410	1041001055	236	104501401	110120	1041002140	232	cs	160200	1042610137	234
100101145	110704	1041010091	236	104506401	119103	1041910137	234	cs	cs	1041002160	236
100101364	110103	1041002026	236	104507401	126101	1042610137	234	cs	cs	1043731161	237
100101365	110104	1041029027	237	104514402	137101	1043701138	235	cs	cs	1051007022	237
100101366	110105	1041002086	232	KN44051	128200	1042801025	237	cs	cs	1050401055	235
100101367	110106	1041002026	236	KN44051	128200	1052807023	235	cs	cs	1051001055	237
100101741	110502	1041010068	233	KN44061	128201	1042801031	237	cs	cs	1052801055	237
100101743	110503	1041020078	236	KN44061	128201	1052807167	237	cs	cs	1053701055	237
100106005	119101	1041910019	237	cs	108302	1040807022	236	cs	cs	1043707022	237
100114075	137502	1043719066	237	cs	108400	1040807058	236	cs	cs	1051010053	237
100213749	127400	1042710087	237	cs	110100	1041007023	232	cs	cs	1053720064	237
100215921	127401	1042710040	237	cs	110139	1041026170	234	cs	cs	1051005127	237
100313749	127402	1042710087	237	cs	110140	1041026171	234	cs	cs	1051010071	237
100315921	127403	1042710040	237	cs	110200	1051007022	237	cs	cs	1042807058	237
100401204	110107	1041002112	232	cs	110200	1041007022	232	cs	cs	1043810053	237
100501204	110108	1041002113	232	cs	110206	1041007034	236	cs	cs	1041407162	237
102060001	110411	1041001055	236	cs	110300	1041007022	232	cs	cs	1041020165	234
102060031	110412	1041001047	236	cs	110400	1042807022	237	cs	cs	1040810166	236
102060291	110305	1041001050	236	cs	110400	1052807022	237	cs	cs	1051010091	237
102066001	137402	1043701055	237	cs	110420	1041026054	237	cs	cs	1053707022	237
102172001	110413	1041002056	236	cs	110500	1040807058	236	cs	cs	1041010168	234
102172031	110414	1041002048	236	cs	110510	1041005127	236	cs	110405	1041010053	236
102315271	110415	1041010045	236	cs	110601	1041010069	236	cs	110416	1041007058	233
102315291	110306	1041010051	236	cs	110602	1041010069	236	cs	137402	1043707058	237
102315341	110307	1041010039	236	cs	110603	1041002070	236				
102904281	110109	1041001036	236	cs	110700	1043707058	237				

CROSS REFERENCE

OEM NO	PART NUMBER	AYS CODE	AYS MANUAL CODE	PAGE NO	OEM NO	PART NUMBER	AYS CODE	AYS MANUAL CODE	PAGE NO
3586	104401053	110204	1041007119	233	281852	100213749	127400	1042710087	237
3587	104501053	110205	1041007118	233	281853	100313749	127402	1042710087	237
4469	104401051	110115	1041007120	233	285951	104401201	110116	1041010114	233
4470	104501051	110118	1041007121	233	285952	100101364	110103	1041002026	236
5966	100001021	110301	1041010049	236	286952	100101364	110103	1041002026	236
5968	100001721	110501	1041010068	233	295148	100101042	110406	1041007058	233
5969	100001128	110403	1041011098	236	295390	100101003	110404	1041026054	237
6045	104407401	126100	1042610132	234	295414	100101047	110407	1041010053	236
6046	104507401	126101	1042610137	234	295567	cs	110136		239
6737	100101743	110503	1041020078	236	341949	104501051	110118	1041007121	233
6899	100002568	137401	1043715072	237	341950	104401051	110115	1041007120	233
7345	100002163	137700	1043710095	237	347870	104501051	110118	1041007121	233
8445	100101364	110103	1041002026	236	347871	104401051	110115	1041007120	233
8446	100401204	110107	1041002112	232	351949	104501051	110118	1041007121	233
8447	100501204	110108	1041002113	232	351950	104401051	110115	1041007120	233
8968	100101047	110407	1041010053	236	351951	104501201	110119	1041010115	233
13180	102172001	110413	1041002056	236	351952	104401201	110116	1041010114	233
18050	102062201	110504		242	449601	cs		1041020165	234
18880	102060031	110412	1041001047	236	505835	100101364	110103	1041002026	236
20850	100101743	110503	1041020078	236	505839	104401201	110116	1041010114	233
20855	100101047	110407	1041010053	236	505840	104501201	110119	1041010115	233
28025	100215921	127401	1042710040	237	663772	100101364	110103	1041002026	236
28026	100315921	127403	1042710040	237	663773	100101364	110103	1041002026	236
31561	100114075	137502	1043719066	237	1186524	102172001	110413	1041002056	236
32928	100012345	139500	1043910044	237	1194362	102172001	110413	1041002056	236
32943	100012901	139300	1043910042	237	1358940	100101743	110503	1041020078	236
33006	100001025	110302	1041010060	236	1448111	cs	110133		239
101258	103015001	139000			1448112	cs	110134		239
157756	104501051	110118	1041007121	233	1448113	cs	110135		239
190656	104407401	126100	1042610132	234	1448114	cs	110123		238
190657	104507401	126101	1042610137	234	1448115	cs	110124		238
194778	102172031	110414	1041002048	236	1448120	cs	110131		238
218684	100101366	110105	1041002086	232	1448121	cs	110132		238
218685	100101009	110102	1041001030	236	1501307	104401032	110114		238
218692	104501051	110118	1041007121	233	1501307	cs	150200		241
218693	104501051	110118	1041007121	233	1501311	104401053	110204	1041007119	233
218832	100101366	110105	1041002086	232	1501311	cs	150400	1041007119	233
225440	104501051	110118	1041007121	233	1505324	104401053	110204	1041007119	233
225441	104501051	110118	1041007121	233	1505324	cs	150400	1041007119	233
225442	104501051	110118	1041007121	233	1505325	104501053	110205	1041007118	233
225443	104501051	110118	1041007121	233	1505325	cs	150300	1041007118	233
236201	cs	138003			1670000	100101047	110407	1041010053	236
236203	cs	138002			7670057	100315921	127403	1042710040	237
236207	cs	138005			7670058	100215921	127401	1042710040	237
236208	cs	138004			8008863	100001021	110301	1041010049	236
265026	cs	110123		238	9000400	103007001	110417	1041002056	236
266673	100101364	110103	1041002026	236	9319019	100001721	110501	1041010068	233
267026	cs	110137		239	21013180	102060001	110411	1041001055	236
267027	cs	110138		239	101401201	104401051	110115	1041007120	233
276517	cs	110133		239	102061241	103003001	110506	1041001079	236
276518	100101366	110105	1041002086	232	104401052	104401053	110204	1041007119	233
276518	cs	110134		239	104501052	104501053	110205	1041007118	233
278734	cs	110135		239	106001021	100001021	110301	1041010049	236
278735	cs	110123		238	106001025	100001025	110302	1041010060	236
278736	cs	110124		238	106001125	100001125	110702	1041010091	236



* INC. > Inclination
* CS > Customer Specific / Özel İmalat

AYS MANUAL BRAKE ADJUSTER TYPES ARE CONTINUOUSLY INCREASED.
PLEASE CONTACT WITH OUR MARKETING DEPARTMENT FOR FURTHER INFORMATIONS.
AYS MEKANİK FREN AYAR KOLLARI SÜREKLİ OLARAK ARTMAKTADIR. DETAYLI BİLGİ İÇİN
PAZARLAMA DEPARTMANI İLE İLETİŞİME GEÇİNİZ.

ALL ORIGINAL NUMBERS, MARKS AND MODELS FROM VEHICLE MANUFACTURERS
LISTED IN THIS CATALOGUE ARE FOR COMPARISON PURPOSES ONLY AND MAY NOT BE
USED IN INVOICES TO VEHICLE OWNERS OR RESELLERS / ORJINAL ÜRÜN NUMARALARI
MÜŞTERİYİ BİLGİLENDİRME VE ÜRÜN REFERANS AMAÇLI KULLANILMIŞTIR.

CROSS REFERENCE

OEM NO	PART NUMBER	AYS CODE	AYS MANUAL CODE	PAGE NO	OEM NO	PART NUMBER	AYS CODE	AYS MANUAL CODE	PAGE NO
106001721	100001721	110501	1041010068	233	4335065150	104507401	126101	1042610137	234
106006001	103006001	110416	1041001055	236	5000716831	cs	132000		241
106007001	100101047	110407	1041010053	236	8241016231	100001125	110702	1041010091	236
106014750	100014750	137500	1043720064	237	8241037367	100001021	110301	1041010049	236
106014753	100014753	137501	1043719065	235	8243000562	100002166	137400	1043715093	237
106060001	102060001	110411	1041001055	236	8283000151	100002163	137700	1043710095	237
106062201	102062201	110504		242	18803400541	100106005	119101	1041910019	237
106066001	102066001	137402	1043701055	237	50583992164	104401201	110116	1041010114	233
106101041	100101041	110303	1041010049	236	50584092165	104501201	110119	1041010115	233
106101042	100101042	110406	1041007058	233	66373392163	100101364	110103	1041002026	236
106101047	100101047	110407	1041010053	236	82830005620	100002167	137600	1043721094	237
106101743	100101743	110503	1041020078	236	99100340001	104406401	119102	1041910132	234
106172001	102172001	110413	1041002056	236	99100340002	104506401	119103	1041910137	234
106407401	104407401	126100	1042610132	234	0004200438	cs	126103		241
106507401	104507401	126101	1042610137	234	01003393	100101047	110407	1041010053	236
433506514	104507401	126101	1042610137	234	01613200	104507401	126101	1042610137	234
433506515	104407401	126100	1042610132	234	01613300	104407401	126100	1042610132	234
800449601	cs		1041020165	234	024089	100001021	110301	1041010049	236
1465201542	100101009	110102	1041001030	236	024090	100001721	110501	1041010068	233
1465201811	100101006	110101	1041002033	236	024490	100001760	110703	1041010071	233
1465201911	100101008	110405	1041002056	236	02828800	102925394	110111	1041001024	236
1465202011	104501401	110120	1041002140	232	028500	100101364	110103	1041002026	236
1465202021	104401401	110117	1041002134	232	028700	104401201	110116	1041010114	233
2021215131	100101047	110407	1041010053	236	028800	104501201	110119	1041010115	233
2100200001	100001021	110301	1041010049	236	0501203316	36004019	119100		242
2100200006	100001027	110401	1041010053	236	0517452100	100101041	110303	1041010049	236
2100200008	100101041	110303	1041010049	236	0517452200	100001125	110702	1041010091	236
2100200011	100101042	110406	1041007058	233	0517452300	100001128	110403	1041011098	236
2100200012	100101047	110407	1041010053	236	0517452340	100001021	110301	1041010049	236
2100200102	100001125	110702	1041010091	236	0517452610	100001721	110501	1041010068	233
2100200108	100101145	110704	1041010091	236	0517452800	100001025	110302	1041010060	236
2100200701	100001721	110501	1041010068	233	0517454690	104407401	126100	1042610132	234
2100200703	100101743	110503	1041020078	236	0517454700	104507401	126101	1042610137	234
2100201101	100002166	137400	1043715093	237	0517456670	cs	126103		241
2100201201	100002568	137401	1043715072	237	0517456840	36004019	119100		242
2100212902	104507401	126101	1042610137	234	0517458640	cs	126105	1042610139	235
2100212903	104407401	126100	1042610132	234	0517458650	cs	126104	1042610135	234
2175001002	100101145	110704	1041010091	236	0517465130	100001760	110703	1041010071	233
2175003700	100101047	110407	1041010053	236	05640700	100002163	137700	1043710095	237
2175007400	100101743	110503	1041020078	236	06310070	100101047	110407	1041010053	236
2175007700	100001025	110302	1041010060	236	0658095	100101365	110104	1041029027	237
3354200338	100001021	110301	1041010049	236	06642300	100001025	110302	1041010060	236
3434200438	100106005	119101	1041910019	237	092162	100101366	110105	1041002086	232
3464201738	104407401	126100	1042610132	234	092163	100101367	110106	1041002026	236
3464201838	104507401	126101	1042610137	234	092164	100401204	110107	1041002112	232
3484201838	104507401	126101	1042610137	234	092165	100501204	110108	1041002113	232
3710001021	100001021	110301	1041010049	236	09319013	100001021	110301	1041010049	236
3854201338	cs	126105	1042610139	235	1.18635	cs	110131		238
4335010000	100001125	110702	1041010091	236	1.18636	cs	110132		238
4335010030	100001128	110403	1041011098	236	1189483	cs	110131		238
4335010060	100001021	110301	1041010049	236	1189484	cs	110132		238
4335010120	100001025	110302	1041010060	236	1670000J13180	100001027	110401	1041010053	236
4335010170	100101041	110303	1041010049	236	18048B	102060001	110411	1041001055	236
4335010290	100001721	110501	1041010068	233	18057/B	102172001	110413	1041002056	236
4335065140	104407401	126100	1042610132	234	18116/B	102066001	137402	1043701055	237

CROSS REFERENCE

OEM NO	PART NUMBER	AYS CODE	AYS MANUAL CODE	PAGE NO	OEM NO	PART NUMBER	AYS CODE	AYS MANUAL CODE	PAGE NO
18883/B	100114075	137502	1043719066	237	CF352726	102060001	110411	1041001055	236
18974/B	103007001	110417	1041002056	236	CF352727	102172001	110413	1041002056	236
281966RH	104501051	110118	1041007121	233	CF950184	102060001	110411	1041001055	236
281967LH	104501051	110118	1041007121	233	CF9501843	102060001	110411	1041001055	236
281968RH	104501053	110205	1041007118	233	DAF46006	100101364	110103	1041002026	236
281969LH	104401053	110204	1041007119	233	DK3328	102925111	110110	1041001030	236
295388LH	104401032	110114		238	FE6737	100101743	110503	1041020078	236
295407RH	104501053	110205	1041007118	233	FE7345	100002167	137600	1043721094	237
295408LH	104401053	110204	1041007119	233	FK713930	100001721	110501	1041010068	233
295414B	100101041	110303	1041010049	236	FK713940	100101145	110704	1041010091	236
32335R	103015001	139000			FK713950	100001021	110301	1041010049	236
4335061030	cs	126103		241	FK713960	100001125	110702	1041010091	236
4335065360	cs	126104	1042610135	234	FL919/001	102925111	110110	1041001030	236
4335065370	cs	126105	1042610139	235	G100114075	100114075	137502	1043719066	237
440.123.20	cs	cs	1041002160	236	G102060031	102060031	110412	1041001047	236
5000716830	cs	132001		241	G102172001	102172001	110413	1041002056	236
A06010601	100001021	110301	1041010049	236	IT1038	104401201	110116	1041010114	233
A4403	100014753	137501	1043719065	235	IT1039	104501201	110119	1041010115	233
A5980	102060001	110411	1041001055	236	IT137	103006001	110416	1041001055	236
A5985	102172001	110413	1041002056	236	KDK3328	102925111	110110	1041001030	236
A5986	103003001	110506	1041001079	236	M004438	103018001	110509	1041017062	236
A5988	102062201	110504		242	M010633	cs	cs	1041002160	236
AJA06294	102922291	110309	1041013052	236	M8039	100101047	110407	1041010053	236
AJA06295	102923341	110310	1041013041	236	M8047	100114075	137502	1043719066	237
AJA077743	100114075	137502	1043719066	237	M8050	102060031	110412	1041001047	236
AJA09921	102916351	137404		242	M8053	102066001	137402	1043701055	237
B4100	100101364	110103	1041002026	236	M8062	103007001	110417	1041002056	236
B4101	100401204	110107	1041002112	232	MEI0201	100001721	110501	1041010068	233
B4102	100501204	110108	1041002113	232	MEI0202	100001025	110302	1041010060	236
CF101425	103009001	137405	1043704063	237	MEI0203	100001021	110301	1041010049	236
CF1014257	103009001	137405	1043704063	237	MEI0204	100101041	110303	1041010049	236
CF350081	103003001	110506	1041001079	236	MEI0205	100001125	110702	1041010091	236
CF3500811	103003001	110506	1041001079	236	MEI0601	100014750	137500	1043720064	237
CF350082	102060031	110412	1041001047	236	MEI0901	104407401	126100	1042610132	234
CF3500824	102060031	110412	1041001047	236	MEI0902	104507401	126101	1042610137	234
CF350083	102062201	110504		242	MEI1101	100101047	110407	1041010053	236
CF3500837	102062201	110504		242	MEI1102	100101042	110406	1041007058	233
CF350823	102060291	110305	1041001050	236	MEI1201	100101743	110503	1041020078	236
CF3508237	102060291	110305	1041001050	236	MEI1402	103007001	110417	1041002056	236
CF351310	102172001	110413	1041002056	236	MEI1403	103006001	110416	1041001055	236
CF3513109	102172001	110413	1041002056	236	MEI1405	102060001	110411	1041001055	236
CF351384	102916351	137404		242	MEI1406	102172001	110413	1041002056	236
CF351385	102917371	110308		242	MEI1408	102062201	110504		242
CF3513853	102917371	110308		242	MEI1411	100014753	137501	1043719065	235
CF351389	102922291	110309	1041013052	236	MEI1412	102066001	137402	1043701055	237
CF351390	102923341	110310	1041013041	236	PE046404	100001721	110501	1041010068	233
CF351607	102317201	110505		242	TP02003040	102060001	110411	1041001055	236
CF3516070	102317201	110505		242	TP02003041	102172001	110413	1041002056	236
CF351728	100215921	127401	1042710040	237	TP02003047	102062201	110504		242
CF3517286	100215921	127401	1042710040	237	TP02003058	100014753	137501	1043719065	235
CF352150	102172031	110414	1041002048	236	Y623192	102172001	110413	1041002056	236
CF3521502	102172031	110414	1041002048	236					
CF352194	100114075	137502	1043719066	237					
CF352195	103006001	110416	1041001055	236					
CF352196	103007001	110417	1041002056	236					



* INC. > Inclination
* CS > Customer Specific / Özel İmalat

AYS MANUAL BRAKE ADJUSTER TYPES ARE CONTINUOUSLY INCREASED.
PLEASE CONTACT WITH OUR MARKETING DEPARTMENT FOR FURTHER INFORMATIONS.
AYS MEKANİK FREN AYAR KOLLARI SUREKLİ OLARAK ARTMAKTADIR. DETAYLI BİLGİ İÇİN
PAZARLAMA DEPARTMANI İLE İLETİŞİME GEÇİNİZ.

ALL ORIGINAL NUMBERS, MARKS AND MODELS FROM VEHICLE MANUFACTURERS
LISTED IN THIS CATALOGUE ARE FOR COMPARISON PURPOSES ONLY AND MAY NOT BE
USED IN INVOICES TO VEHICLE OWNERS OR RESELLERS / ORJINAL ÜRÜN NUMARALARI
MÜŞTERİYİ BİLGİLENDİRME VE ÜRÜNE REFERANS AMAÇLI KULLANILMIŞTIR.

Lined area for notes.

www.aydinsan.com



**AYDINSAN FREN CIRCIRLARI
OTOMOTİV YEDEK PARÇA
SAN. TİC. LTD. ŞTİ.**

Address : Konya Organize Sanayi Bölgesi
T. Ziyaeddin Cad. 8 No'lu Sok. No:26
Selçuklu / Konya / TÜRKİYE

Phone : +90 (332) 239 09 15
Fax : +90 (332) 239 11 64

aydinsan@aydinsan.com
www.aydinsan.com



KOSGEB
www.kosgeb.gov.tr
Basım Tarihi : 05.04.2011